



---

**1987\***

---

**BMW L6/M6**

---

**Electrical**

---

**Troubleshooting**

---

**Manual**

---

**\* 1987 Vehicles Built Before  
9/86 Use 1986 635CSi Electrical  
Troubleshooting Manual  
For Diagnostics**

**BMW of North America, Inc.  
Montvale, New Jersey**

### FOREWORD

In the interests of continuing technical development work we reserve the right to modify designs and equipment.

Printed in USA

©Copyright BMW of North America, Inc.

Not to be reproduced wholly or in part without written permission of BMW of North America, Inc.

PN 89 89 1 000 187

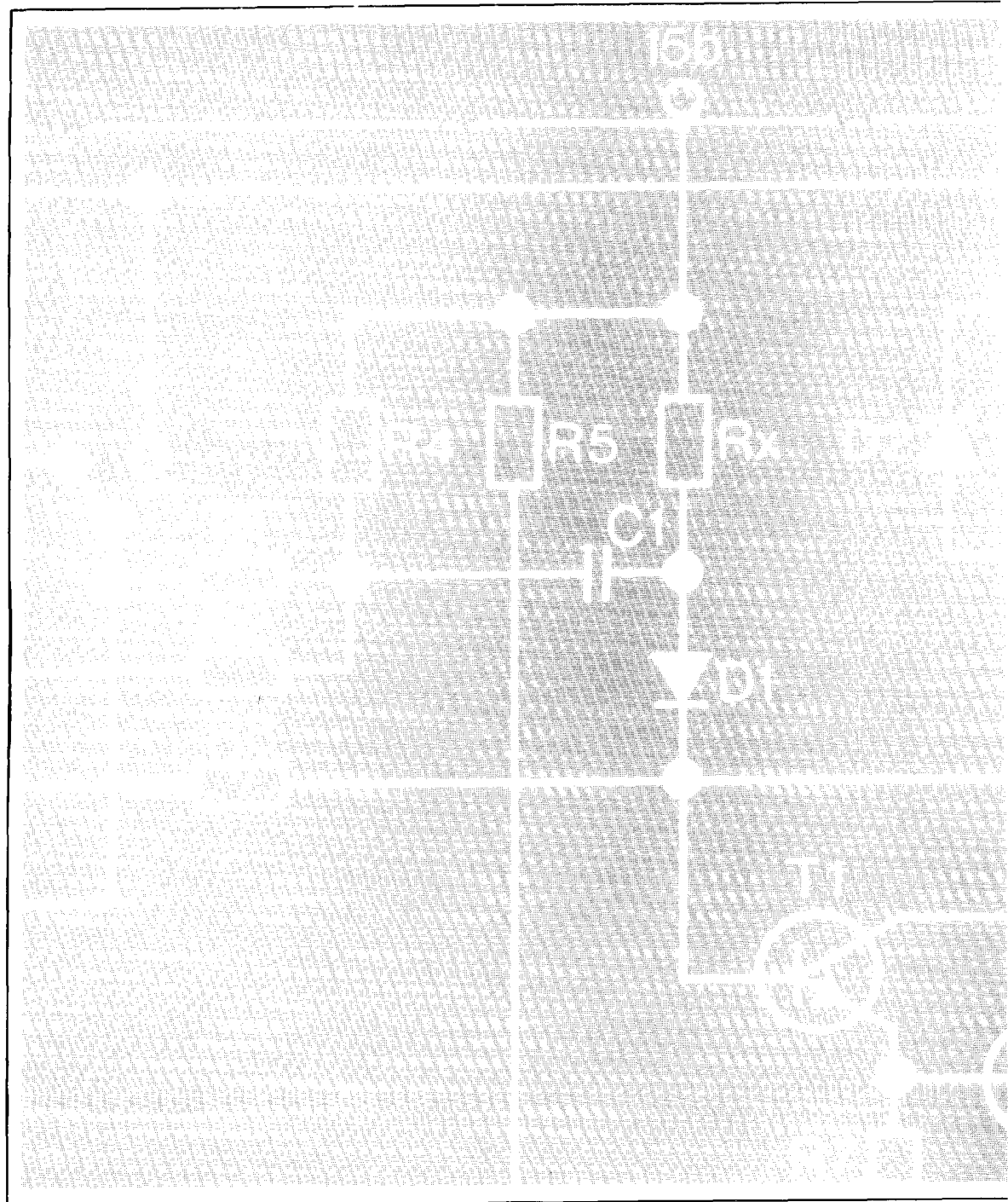

**1987\***  
**BMW L6/M6**  
**Electrical**  
**Troubleshooting**  
**Manual**

**CONTENTS**

---

Index . . . . .	2
How To Use This Manual . . . . .	3
Symbols . . . . .	4
Wire Size Conversion Chart . . . . .	5
Systematic Troubleshooting . . . . .	6
Connector Views . . . . .	8500-0
Power Distribution Box . . . . .	0670-0
Fuse Data . . . . .	0670-1
Component Location Chart . . . . .	9000-0
Component Location Views . . . . .	7000-0
Splice Location Views . . . . .	8000-0

---

**\* 1987 Vehicles Built Before  
9/86 Use 1986 635CSi Electrical  
Troubleshooting Manual**

The purpose of this manual is to show electrical schematics in a manner that makes electrical troubleshooting easier. Electrical components which work together are shown together on one schematic. The Wiper-Washer schematic, for example, shows all of the electrical components in one diagram. At the top of the page is the fuse (positive) that powers the circuit. The flow of current is shown through all wires, connectors, switches, and motors to ground (negative) at the bottom of the page.

Within the schematic, all switches and sensors are shown "at rest," as though the Ignition Switch were off. For identification, component names are underlined and placed next to or above each component. Notes are included, describing how switches and other components work.

The power distribution schematic shows the current feed through all the connections from the Battery and Alternator to each fuse and the Ignition and Light Switches. If the Power Distribution schematic is combined with any other circuit schematic, a complete picture is made of how that circuit works. The Ground Distribution schematics show how several circuits are connected to common grounds.

All wiring between components is shown exactly as it exists in the vehicle; however, the wiring is not drawn to scale. To aid in understanding electrical operation, wiring inside complicated components has been simplified. The "Solid State" label designates electronic components.

WIRE SIZE CONVERSION CHART	
METRIC (CROSSSECTIONAL AREA IN MM <sup>2</sup> )	AWG (AMERICAN WIRE GAUGE)
.5	20
.75	18
1	16
1.5	14
2	14
2.5	12
4	10
6	8
8	8
16	4
20	4
25	2
32	2

WIRE INSULATION	
ABBREVIATIONS	COLOR
BK	BLACK
BR	BROWN
RD	RED
YL	YELLOW
GN	GREEN
BU	BLUE
VI	VIOLET
GY	GRAY
WT	WHITE
PK	PINK



# 4 SYMBOLS

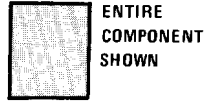

ENTIRE COMPONENT SHOWN

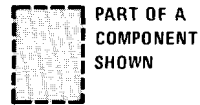

PART OF A COMPONENT SHOWN

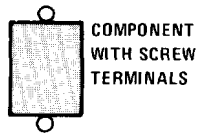

COMPONENT WITH SCREW TERMINALS



SOLID STATE (INCLUDES ONLY ELECTRONIC PARTS)

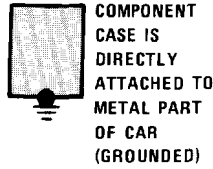

COMPONENT CASE IS DIRECTLY ATTACHED TO METAL PART OF CAR (GROUNDED)

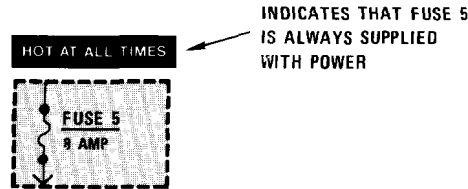

INDICATES THAT FUSE 5 IS ALWAYS SUPPLIED WITH POWER

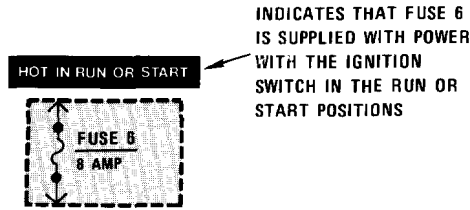

INDICATES THAT FUSE 6 IS SUPPLIED WITH POWER WITH THE IGNITION SWITCH IN THE RUN OR START POSITIONS

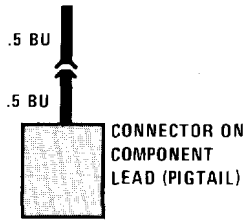
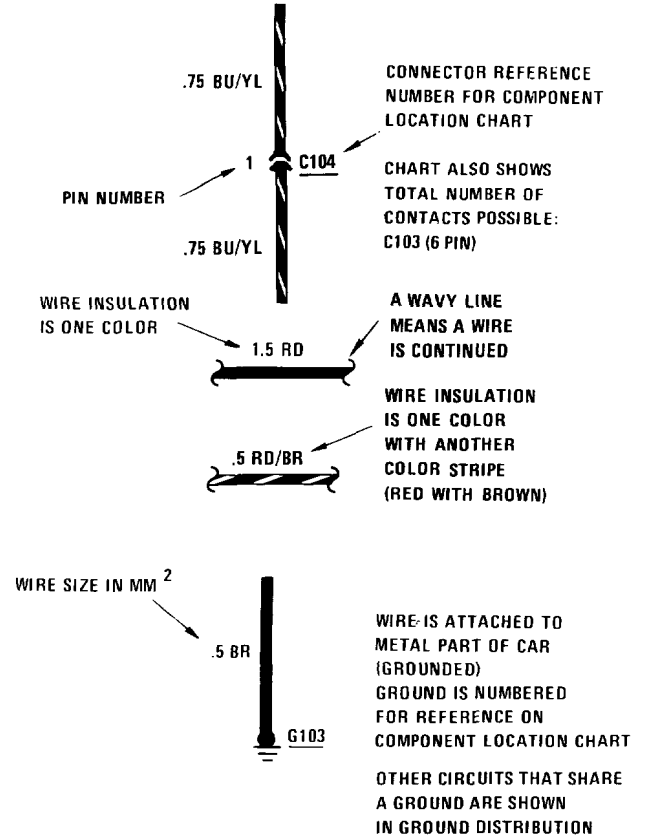

CONNECTOR ON COMPONENT LEAD (PIGTAIL)

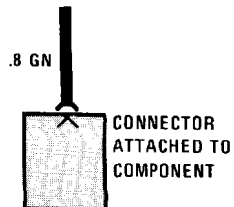

CONNECTOR ATTACHED TO COMPONENT

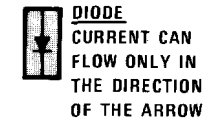
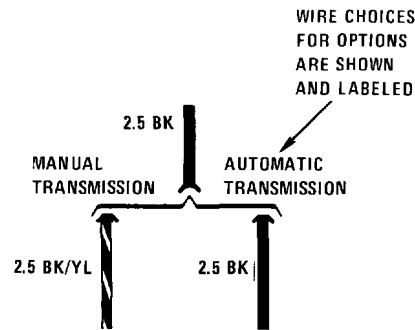

DIODE CURRENT CAN FLOW ONLY IN THE DIRECTION OF THE ARROW

CIRCUIT REFERENCE - A WIRE WHICH CONNECTS TO ANOTHER CIRCUIT



ACTIVE CHECK CONTROL

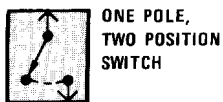

ONE POLE,  
TWO POSITION  
SWITCH



SWITCHES THAT  
MOVE TOGETHER  
DASHED LINE SHOWS  
A MECHANICAL  
CONNECTION  
BETWEEN SWITCHES

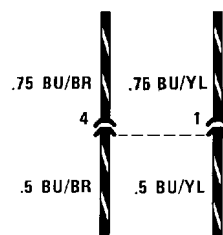

TWO CONNECTIONS  
(PINS) IN THE SAME  
CONNECTOR  
DASHED LINE SHOWS  
PARTS OF THE  
SAME CONNECTOR

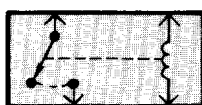

WHEN COIL IS  
ENERGIZED, SWITCH  
IS PULLED CLOSED

RELAY SHOWN  
WITH NO  
CURRENT  
FLOWING  
THROUGH  
COIL

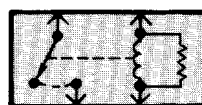

RESISTOR ACROSS COIL  
IS FOR NOISE  
SUPPRESSION

RELAY SHOWN  
WITH RESISTOR  
ACROSS COIL

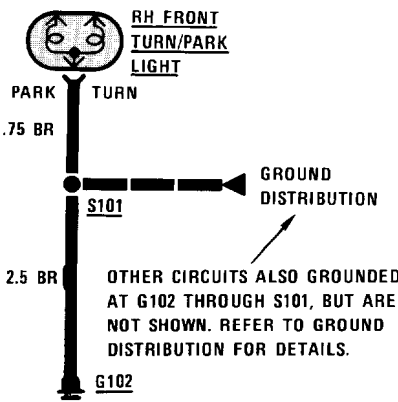

OTHER CIRCUITS ALSO GROUNDED  
AT G102 THROUGH S101, BUT ARE  
NOT SHOWN. REFER TO GROUND  
DISTRIBUTION FOR DETAILS.

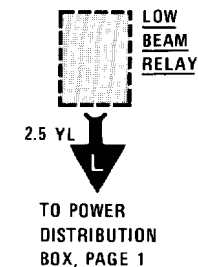
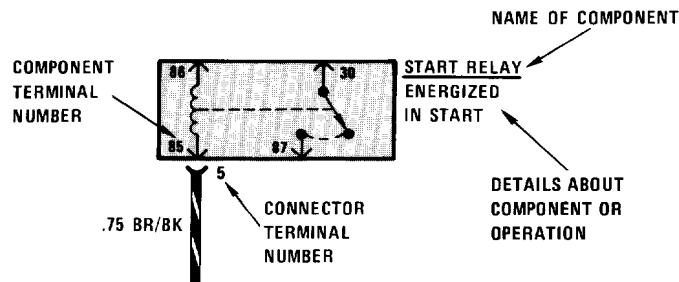

CURRENT PATH  
IS CONTINUED  
AS LABELED.  
THE ARROW SHOWS  
DIRECTION OF CURRENT  
FLOW AND IS REPEATED  
WHERE CURRENT  
PATH CONTINUES.

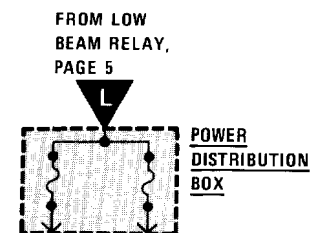

LIGHT  
EMITTING  
DIODE

## 6 SYSTEMATIC TROUBLESHOOTING

### TROUBLESHOOTING PROCEDURE

#### 1. Verify the Problem

Operate the problem circuit to check the accuracy of the complaint. Note the symptoms of the inoperative circuit.

#### 2. Analyze the Problem

Refer to the schematic of the problem circuit in the ETM. Determine how the circuit is supposed to work by tracing the current path(s) from the power feed through the circuit components to ground. Then based on the symptoms you noted in step 1 and your understanding of circuit operation, identify one or more possible causes of the problem.

#### 3. Isolate the Problem

Make circuit tests to prove or disprove the preliminary diagnosis made in step 2. Keep in mind that a logical simple procedure is the key to efficient troubleshooting. Test for the most likely cause of failure first. Try to make tests at points which are easily accessible.

#### 4. Repair the Problem

Once the specific problem is identified, make the repair using the proper tools and safe procedures.

#### 5. Check the Problem

Operate the circuit to check for satisfactory circuit operation. Good repair practice calls for rechecking all circuits you have worked on.

### TROUBLESHOOTING TOOLS

Isolating the problem (Step 3 of TROUBLESHOOTING PROCEDURES) requires the use of a **voltmeter** and/or **ohmmeter**. A voltmeter measures voltage at selected points in a circuit. An ohmmeter measures a circuit's resistance to current flow. It has an internal battery that provides current to the circuit under test. Disconnect the car battery when using an ohmmeter because the battery voltage will cause the ohmmeter to give false readings. Also, do not use an ohmmeter on solid-state components. The voltage that the ohmmeter applies to the circuit could damage these components.

### TROUBLESHOOTING TESTS

#### Voltage Test

This test measures voltage in a circuit. By taking measurements at several points (terminals or connectors) along the circuit, you can isolate the problem.

To take a voltage measurement, connect the negative lead of the voltmeter to the battery's negative terminal or other known good ground. Then connect the positive lead of the voltmeter to the point you want to test. The voltmeter will measure the voltage present at that point in the circuit.

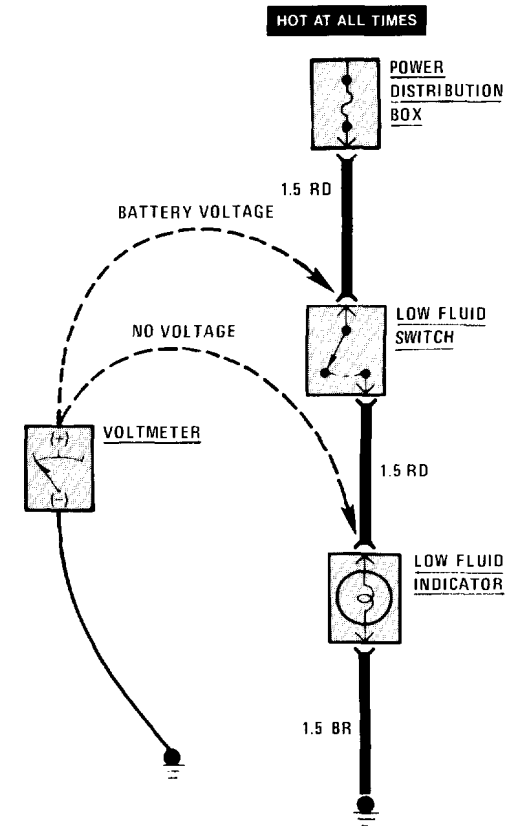

Voltage Test

Voltage Drop Test

Wires, connectors, and switches are designed to conduct current with a minimum loss of voltage. A voltage drop of more than one volt indicates a problem.

To test for voltage drop, connect the voltmeter leads to connectors at either end of the circuit's suspected problem area. The positive lead should be connected to the connector closest to the power source. The voltmeter will show the voltage drop between these two points.

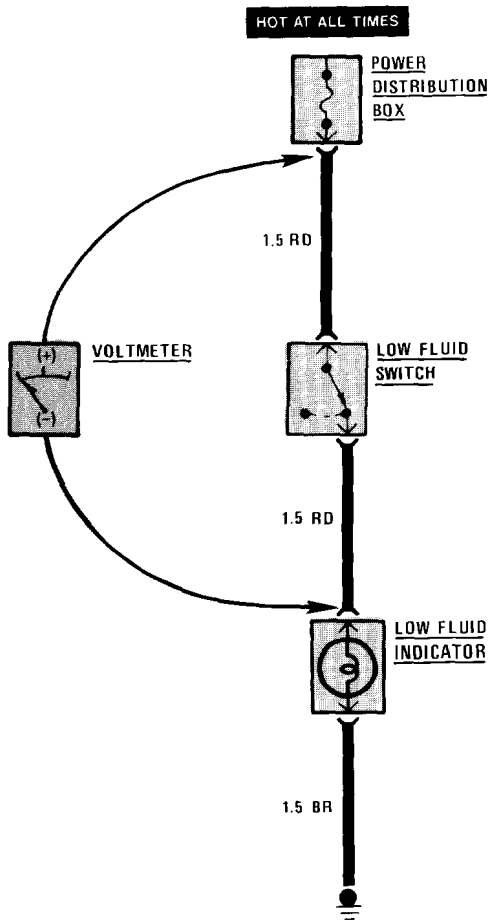

Voltage Drop Test

Continuity Test

To perform a continuity test, first disconnect the car battery. Then adjust the ohmmeter to read zero while holding the leads together. Connect the ohmmeter leads to connector or terminals at either end of the circuit's suspected problem area. The ohmmeter will show the resistance across that part of the circuit.

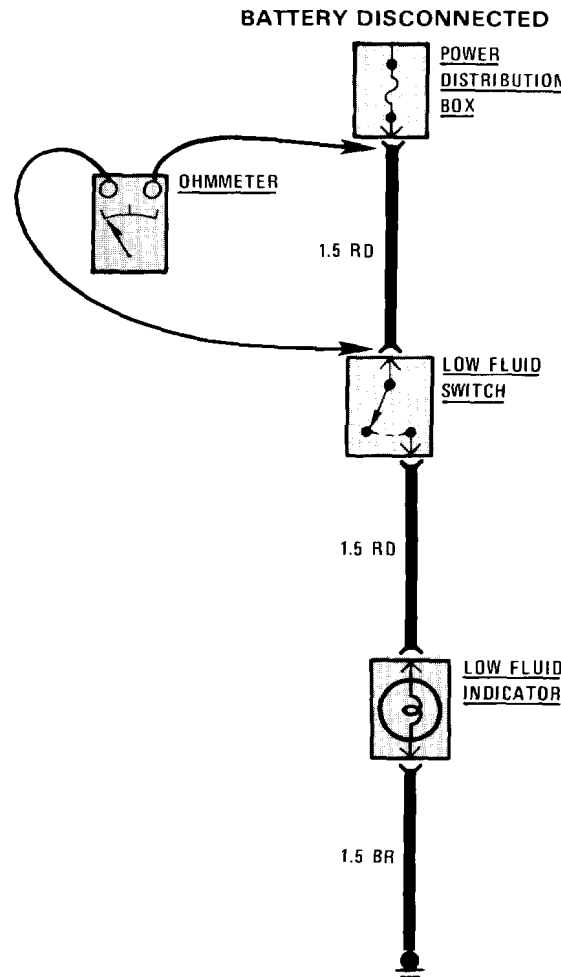

Continuity Test

Short Test Using Voltmeter

Remove the blown fuse and disconnect the load. Connect the voltmeter leads to the fuse terminals. The positive lead should be connected to the terminal closest to the power source.

Starting near the POWER DISTRIBUTION BOX, move the wire harness back and forth and watch the voltmeter reading. If the voltmeter registers a reading, there is a short to ground in the wiring. Somewhere in the area of the harness being moved, the wire insulation is worn away and the circuit is grounding.

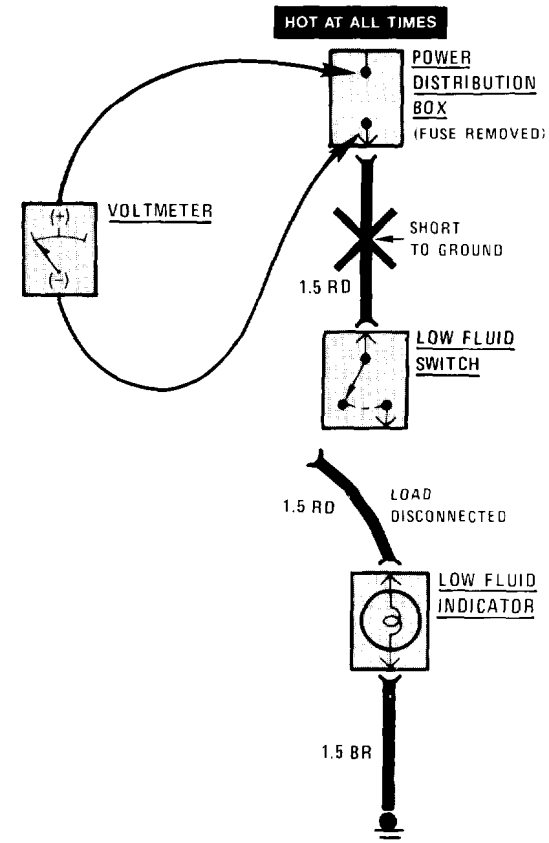

Short Test Using Voltmeter

## 8 SYSTEMATIC TROUBLESHOOTING

### Short Test Using Ohmmeter

Disconnect the battery. Adjust the ohmmeter to read zero while holding the leads together. Remove the blown fuse and disconnect the load. Connect one lead of the ohmmeter to the fuse terminal that is closest to the load. Connect the other lead to a known good ground.

Starting near the POWER DISTRIBUTION BOX, move the wire harness back and forth and watch the ohmmeter reading. Low or no resistance indicates a short to ground in the wiring. Infinitely high resistance indicates no short.

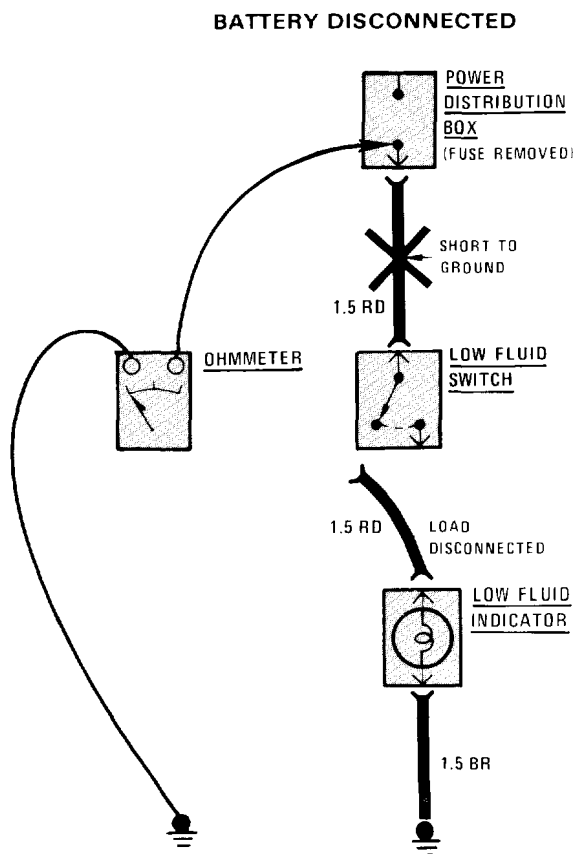

Short Test Using Ohmmeter

# 0670-0 POWER DISTRIBUTION

## POWER DISTRIBUTION BOX

**MAIN RELAY**

635 CSi, L6 ONLY

**NOTE**  
On some cars, the position of the Fuel Pump and Oxygen Sensor Heater Relays may be the opposite of what is shown. Check relay wire colors for positive identification.

**DIAGNOSTIC CONNECTOR**

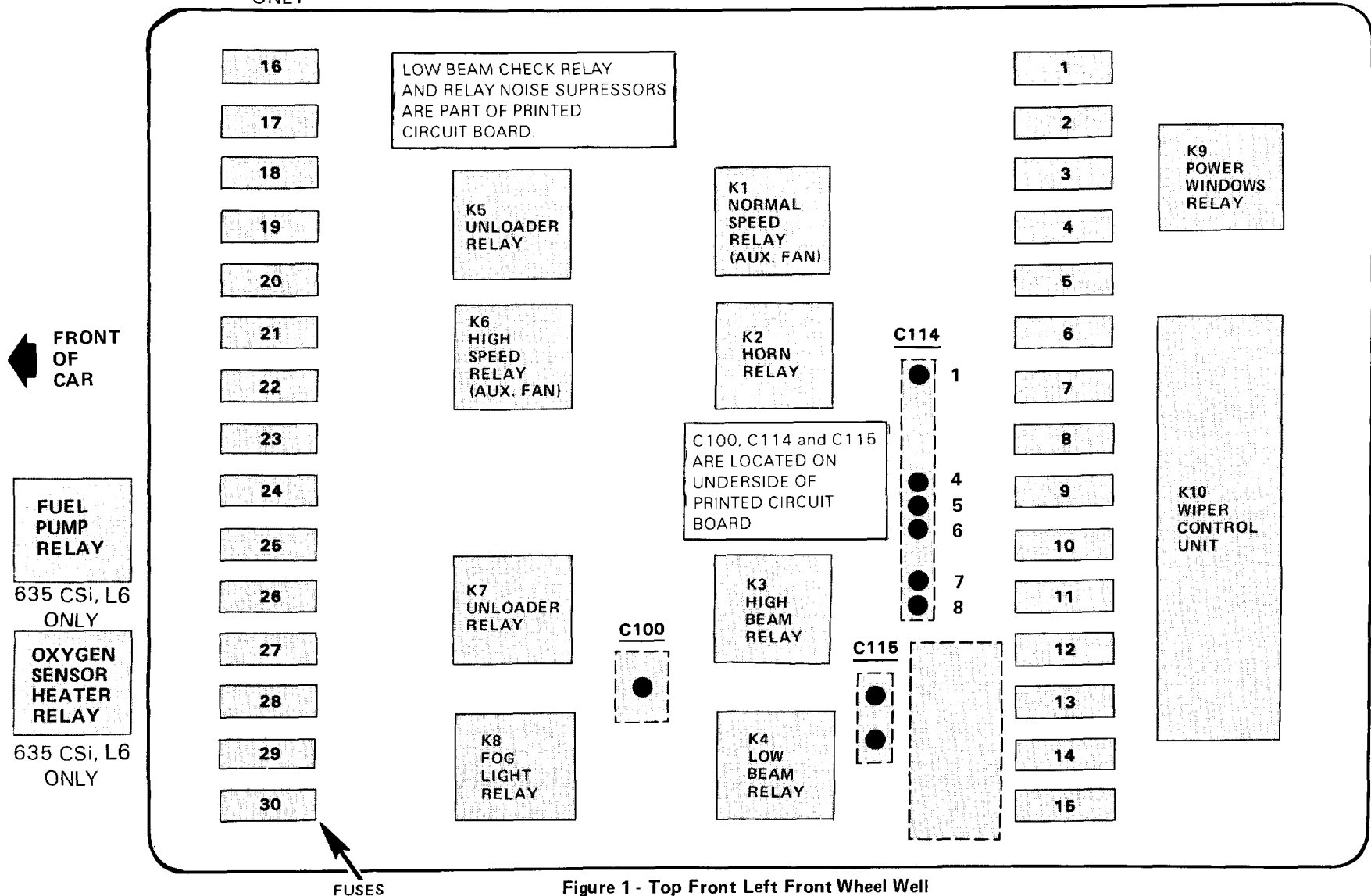

Figure 1 - Top Front Left Front Wheel Well

FUSE DATA CHART

FUSE NO.	SIZE	CIRCUIT PROTECTED
1	7.5A	Headlights (also fuses 2, 13, 14).
2	7.5A	Headlights (also fuses 1, 13, 14).
3	30A	Auxiliary Fan (also fuses 18, 19).
4	15A	Lights: Turn/Hazard Warning (also fuse 24).
5	30A	Wiper/Washer, Windshield Washer Jet Heater.
6	7.5A	Active Check Control (also fuses 10, 12, 21, 22, 23); Antilock Braking System; Cruise Control (also fuse 10); Self-Leveling Suspension (also fuses 19, 25); Stoplights.
7	15A	Horn.
8	30A	Rear Defogger (also fuse 23).
9	7.5A	Injection Electronics (also fuses 11, 21).
10	7.5A	Active Check Control (also fuses 6, 12, 21, 22, 23); Ignition Key Warning (also fuses 19, 21); On-Board Computer (also fuses 12, 21, 27); Speedometer/Gauges Warning Indicators (also fuse 21); Back Up Lights; Brake Lining Warning; Cruise Control (also fuse 6); Service Interval Indicator (also fuse 21); Seatbelt Warning (also fuses 19, 21); Electronic Transmission Control.
11	15A	Fuel Delivery; Injection Electronics (also fuses 19, 21).
12	7.5A	Active Check Control (also fuse 6, 10, 21, 22, 23); On-Board Computer (also fuses 10, 21, 27); Radio (also fuses 21, 28. Radio In-Line Fuse); Warning Indicators
13	7.5A	Headlights (also fuses 1, 2, 14).
14	7.5A	Headlights (also fuses 1, 2, 13).
15	—	Not Used.
16	15A	Heated Seats.
17	—	Not Used.
18	30A	Auxiliary Fan (also fuses 3, 19).

FUSE NO.	SIZE	CIRCUIT PROTECTED
19	30A	Auxiliary Fan (also fuses 3, 18); Heater/Air Conditioning (also fuses 20, 23); Ignition Key Warning (also fuses 10, 21); Interior Lights (also fuse 21); Power Seats (also fuse 26); Power Mirrors; Seatbelt Warning (also fuses 9, 21); Self-Leveling Suspension (also fuses 6, 25).
20	30A	Heater/Air Conditioner (also fuses 19, 23).
21	7.5A	Active Check Control (also fuses 6, 10, 12, 22, 23); Auto-Charging Flashlight; Gauges (also fuses 10, 12); Glove Box Light; Ignition Key Warning (also fuses 10, 19); Interior Lights (also fuse 19); Injection Electronics (also fuses 9, 11); On-Board Computer (also fuses 10, 12, 27); Radio (also fuses 12, 28. Radio In-Line Fuse); Seatbelt Warning (also fuses 10, 19); Service Interval Indicator (also fuse 10); Trunk Light.
22	7.5A	Active Check Control (also fuses 6, 10, 12, 21, 23); Lights: Front Park/Tail (also fuse 22).
23	7.5A	Active Check Control (also fuses 6, 10, 12, 21, 22); Rear Defogger (also fuse 8); Lights: Front Park/Tail/Underhood/ (also fuse 22); Heater/Air Conditioning (also fuses 19, 20); Lights: Dash/Transmission Range/RH Visor Lights: Rear Marker/License.
24	15A	Lights: Turn/Hazard Warning (also fuse 4).
25	25A	Self-Leveling Suspension (also fuses 6, 19).
26	30A	Power Seats (also fuse 19).
27	30A	Central Locking; Heated Door Lock; On-Board Computer (also fuses 10, 12, 21).
28	30A	Cigar Lighter; Power Antenna (also fuses 12, 21, Radio In-Line Fuse).
29	7.5A	Fog Lights (also fuse 30).
30	7.5A	Fog Lights (also fuse 29).
Power Window Circuit Breaker	25A	Power Windows; Sunroof.

# 0670-2 POWER DISTRIBUTION 3.5i ENGINE

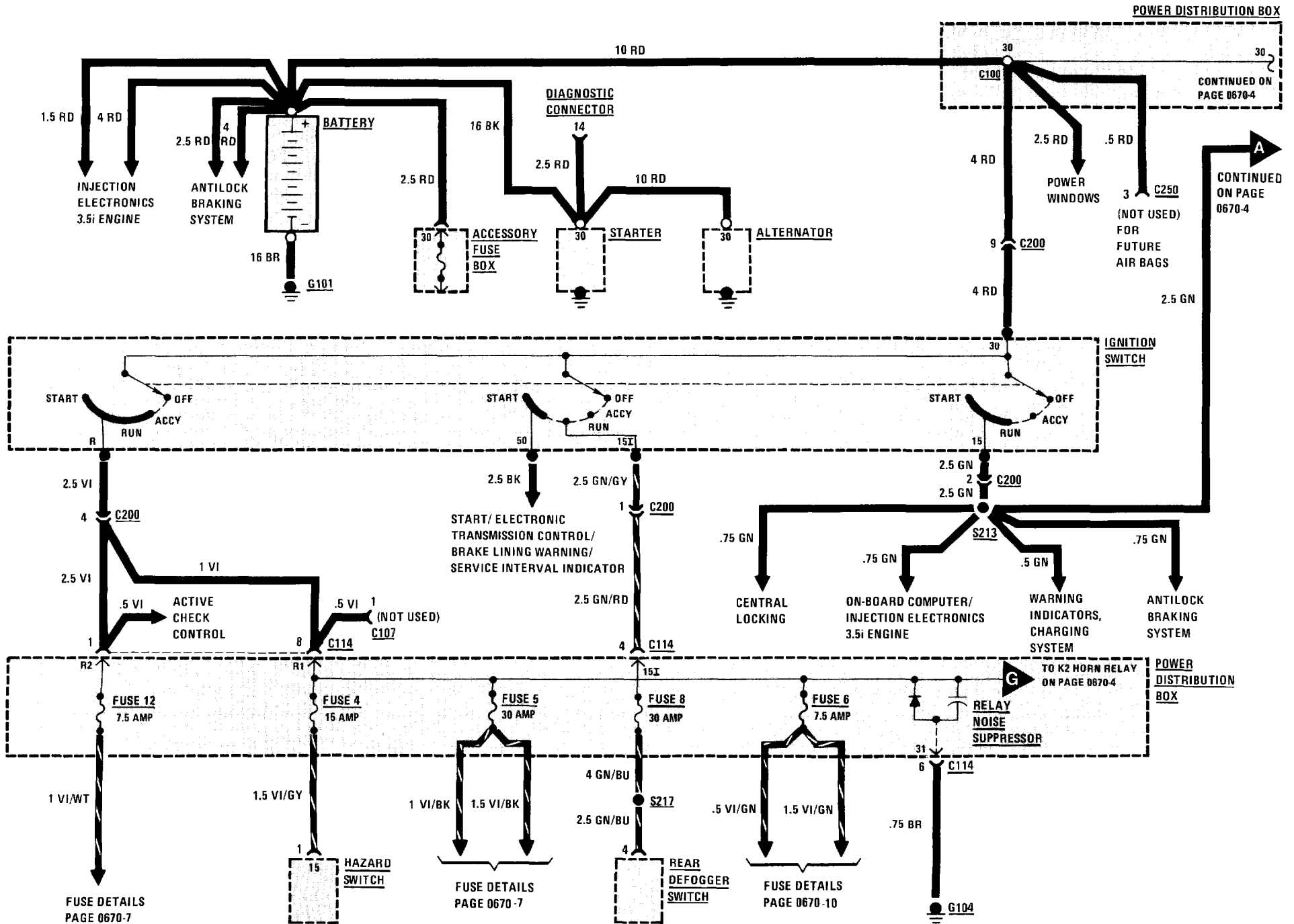



# S38 ENGINE POWER DISTRIBUTION 0670-3

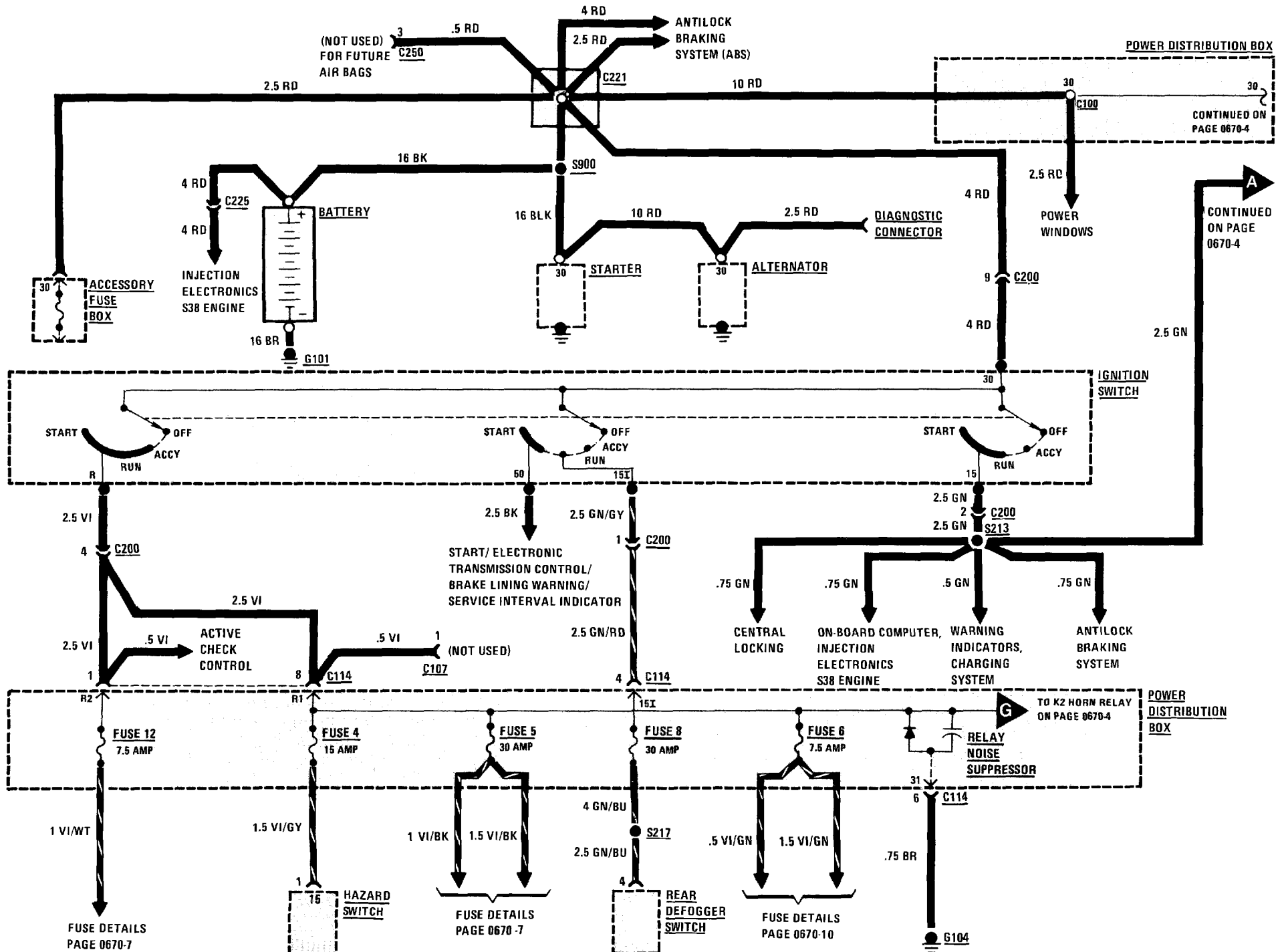

# 0670-4 POWER DISTRIBUTION

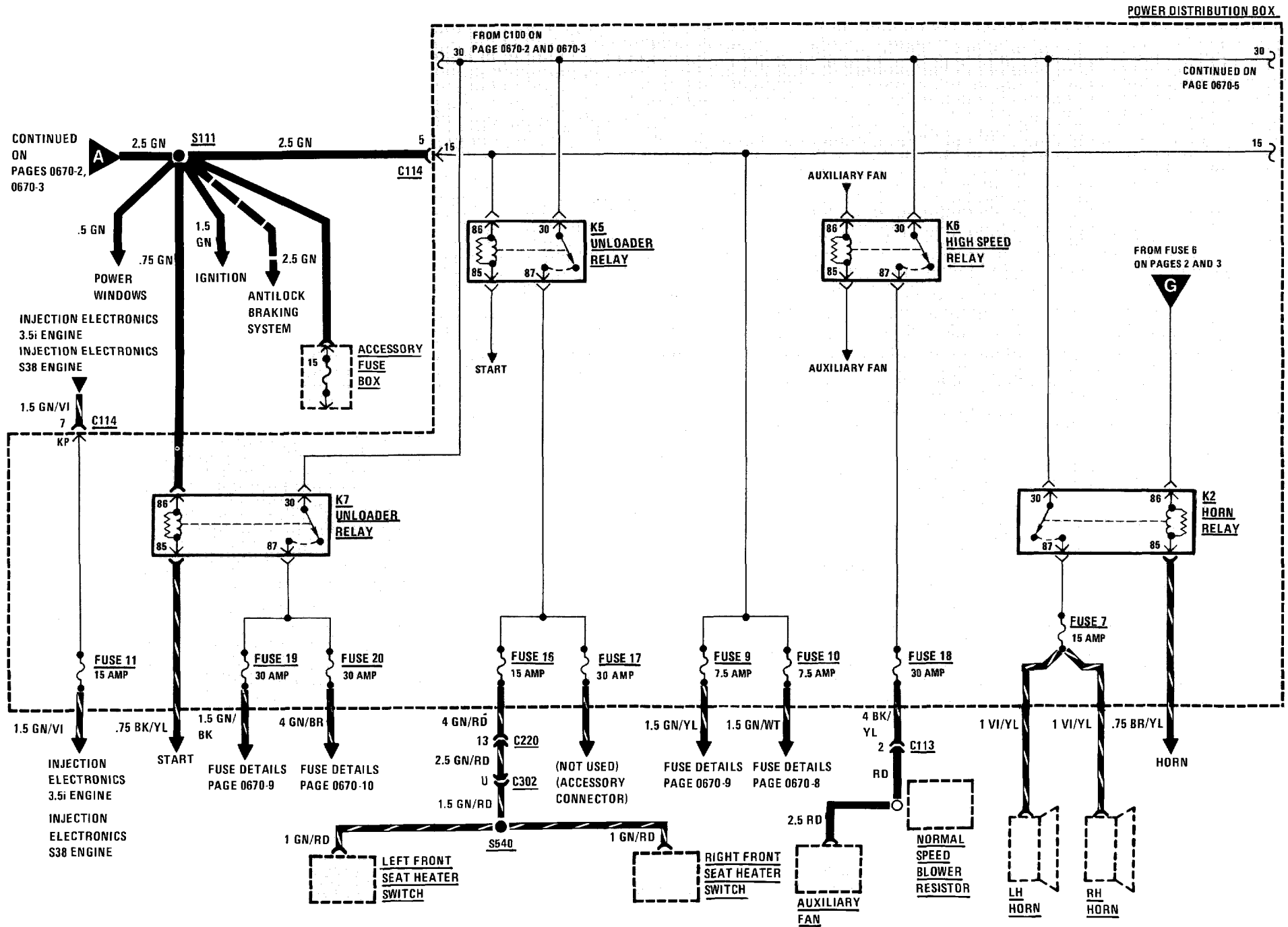

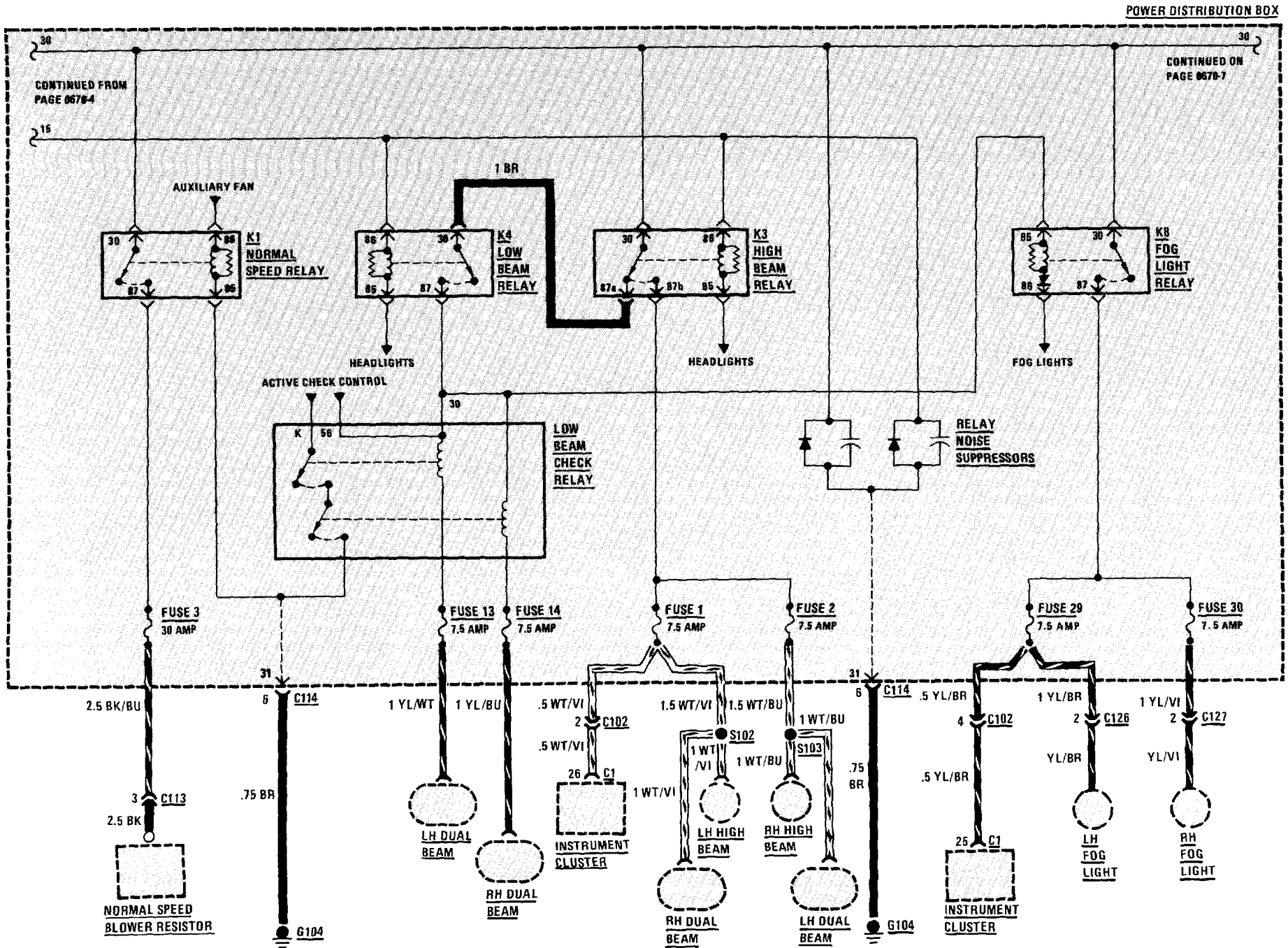

# 0670-6 POWER DISTRIBUTION

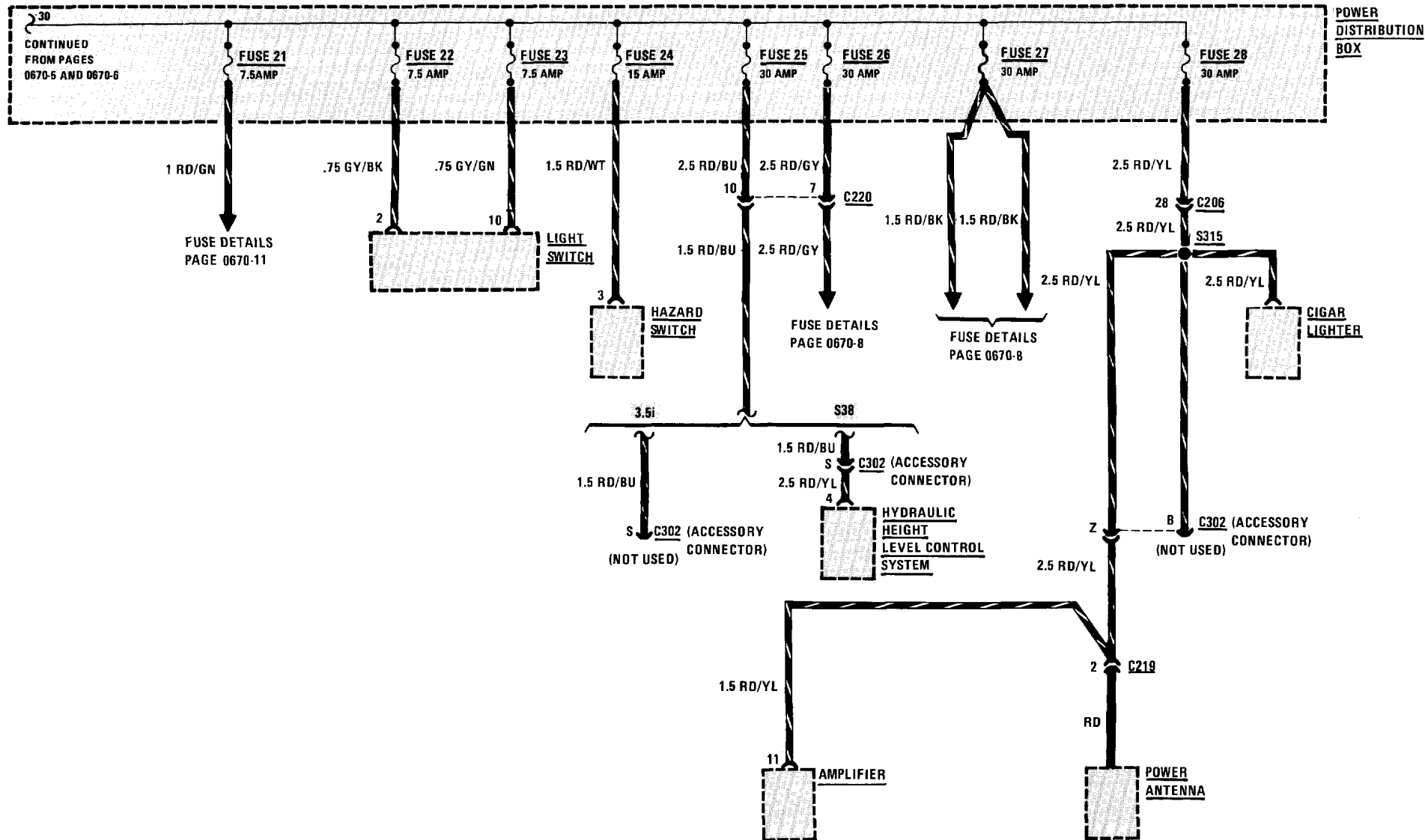

FUSE DETAILS: FUSES 12 AND 5

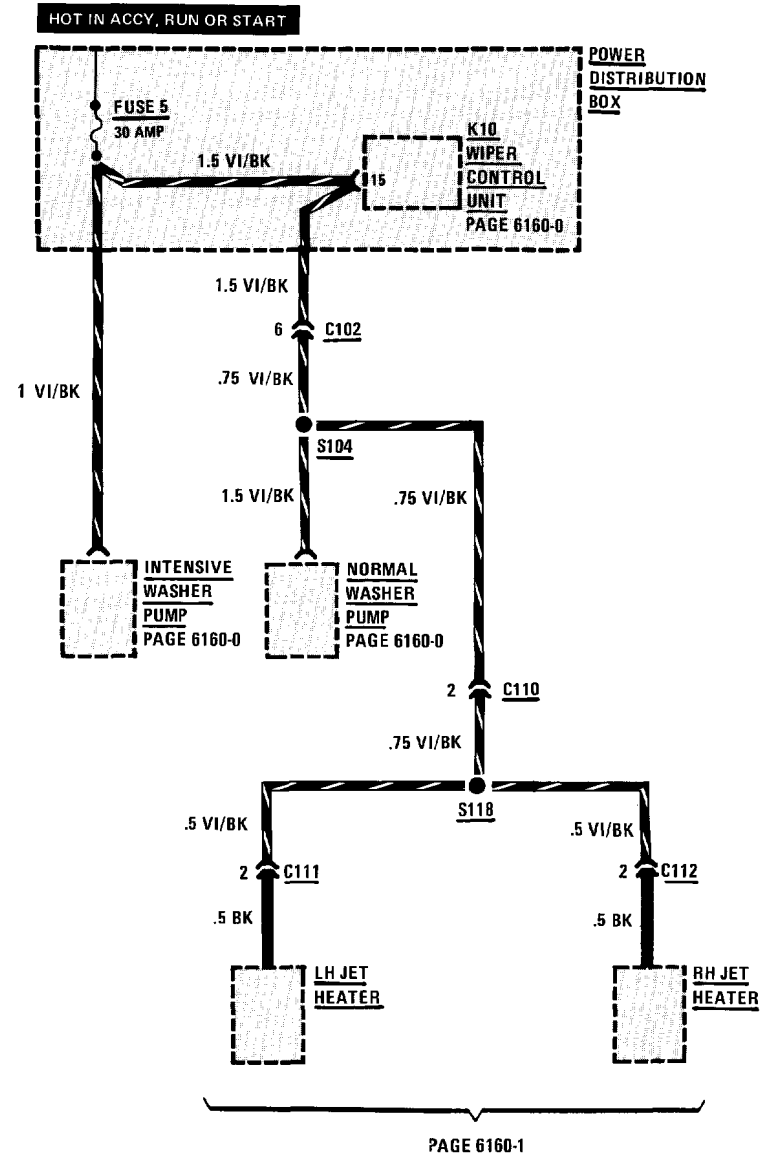
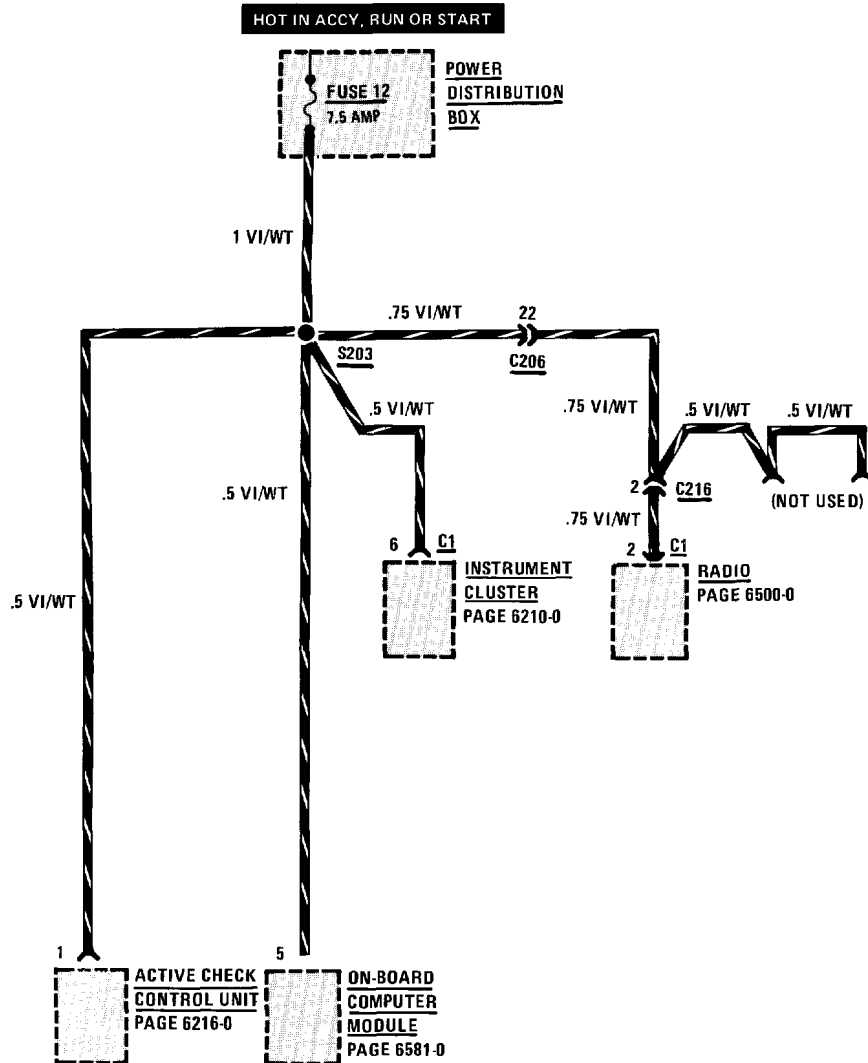

# 0670-8 POWER DISTRIBUTION

## FUSE DETAILS: FUSES 10, 26 AND 27

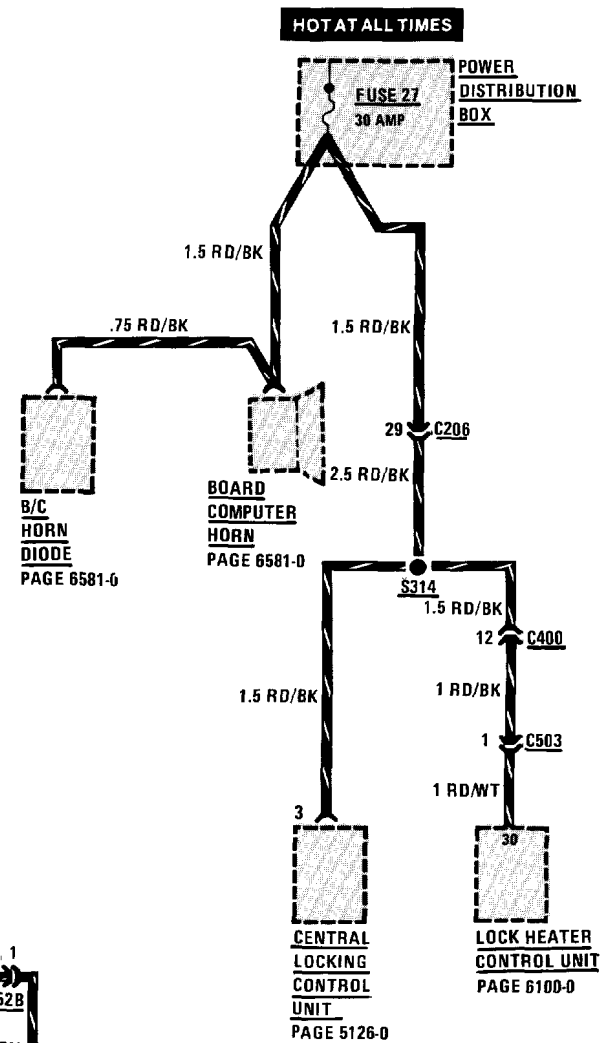
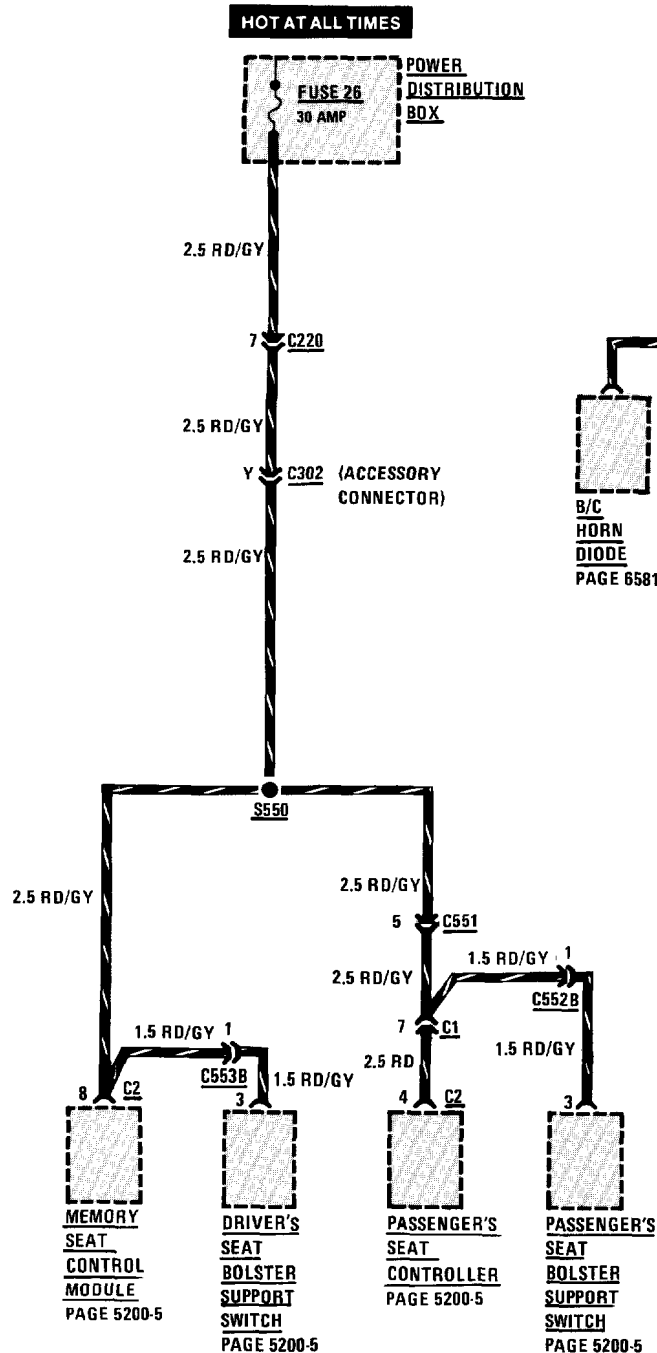
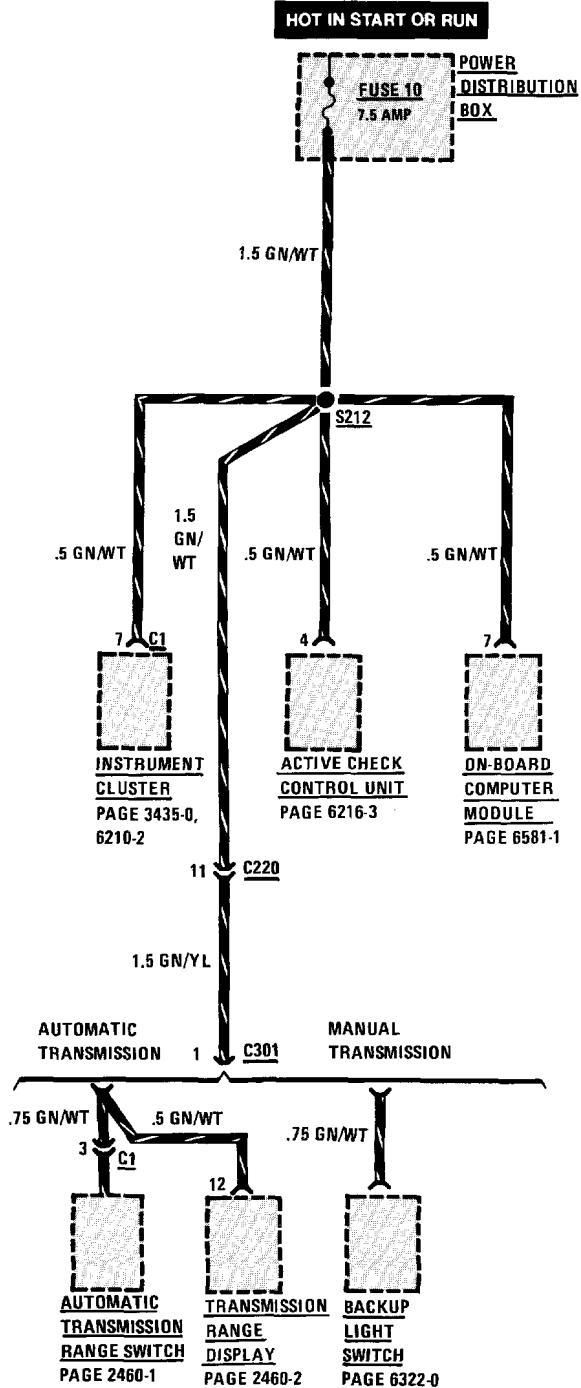

FUSE DETAILS: FUSES 19 AND 9

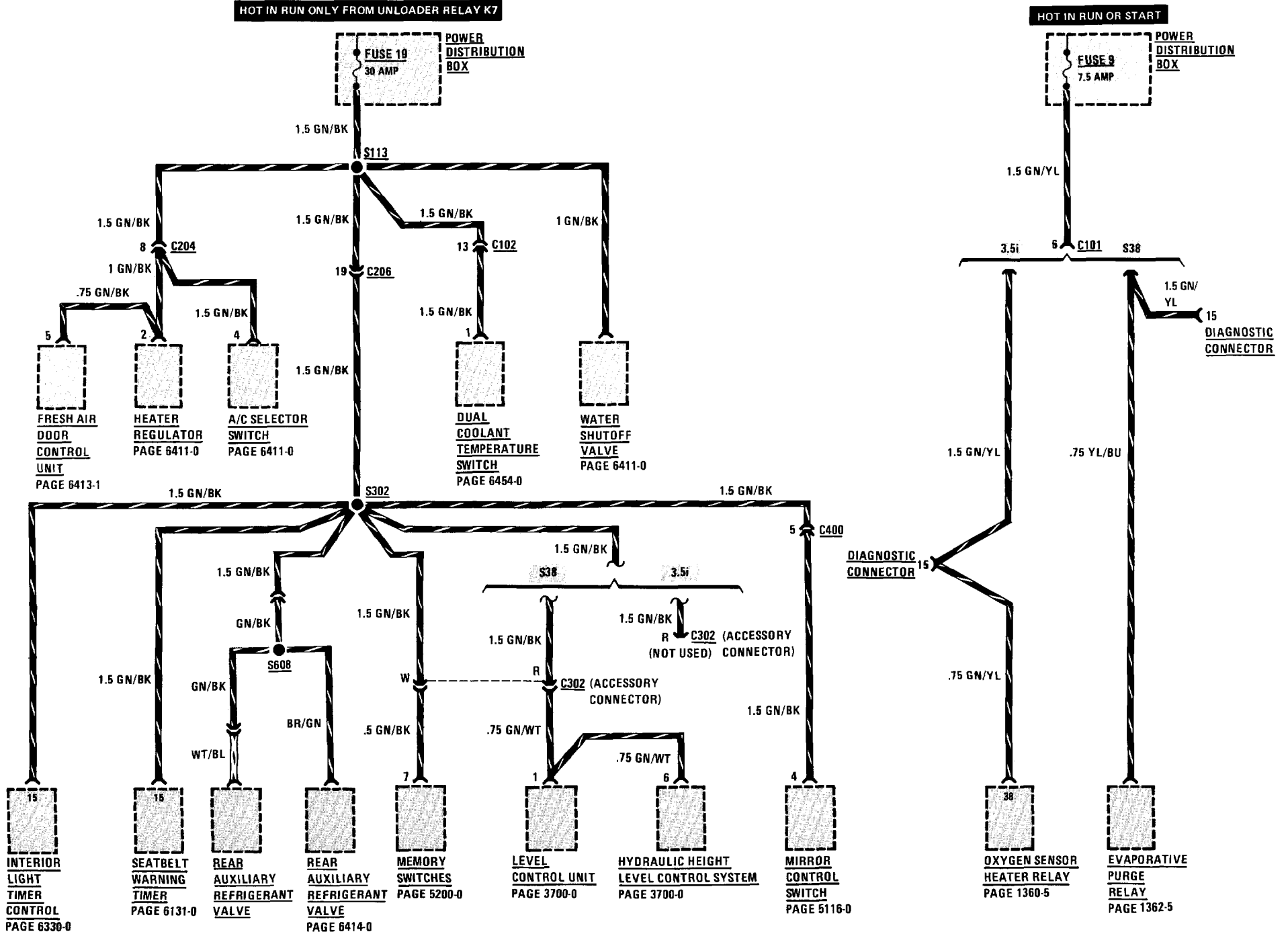

# 0670-10 POWER DISTRIBUTION

## FUSE DETAILS: FUSES 6 AND 20

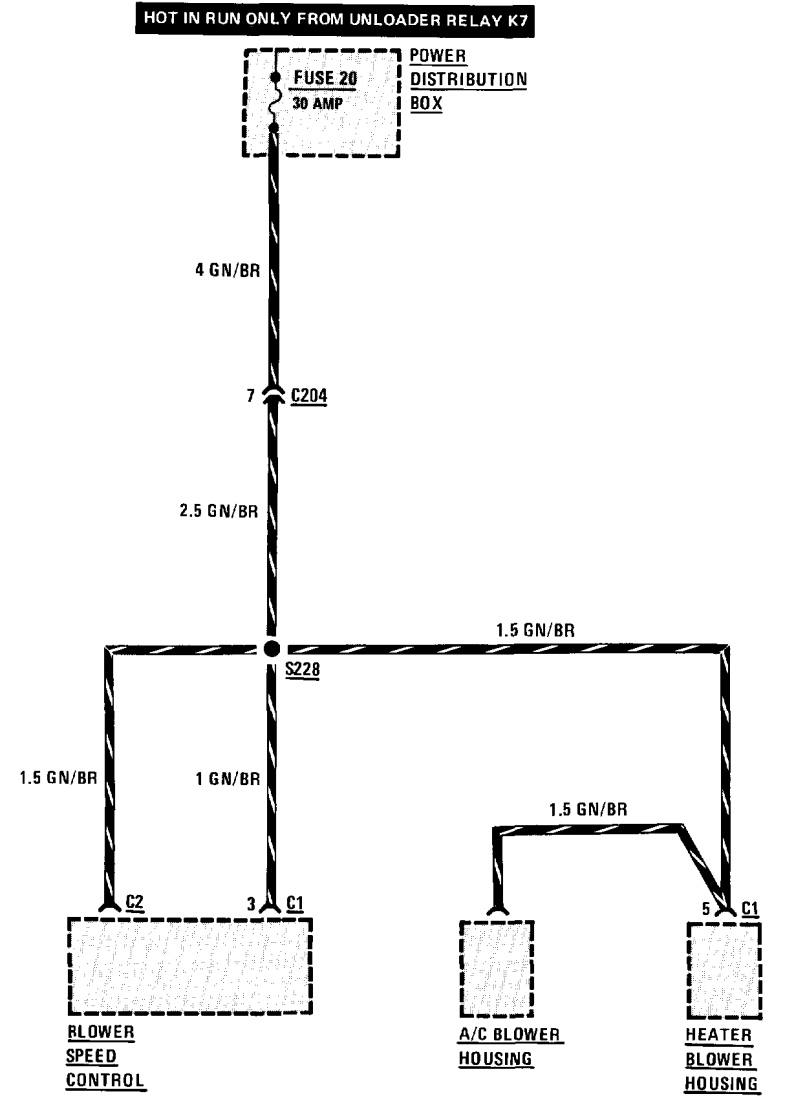
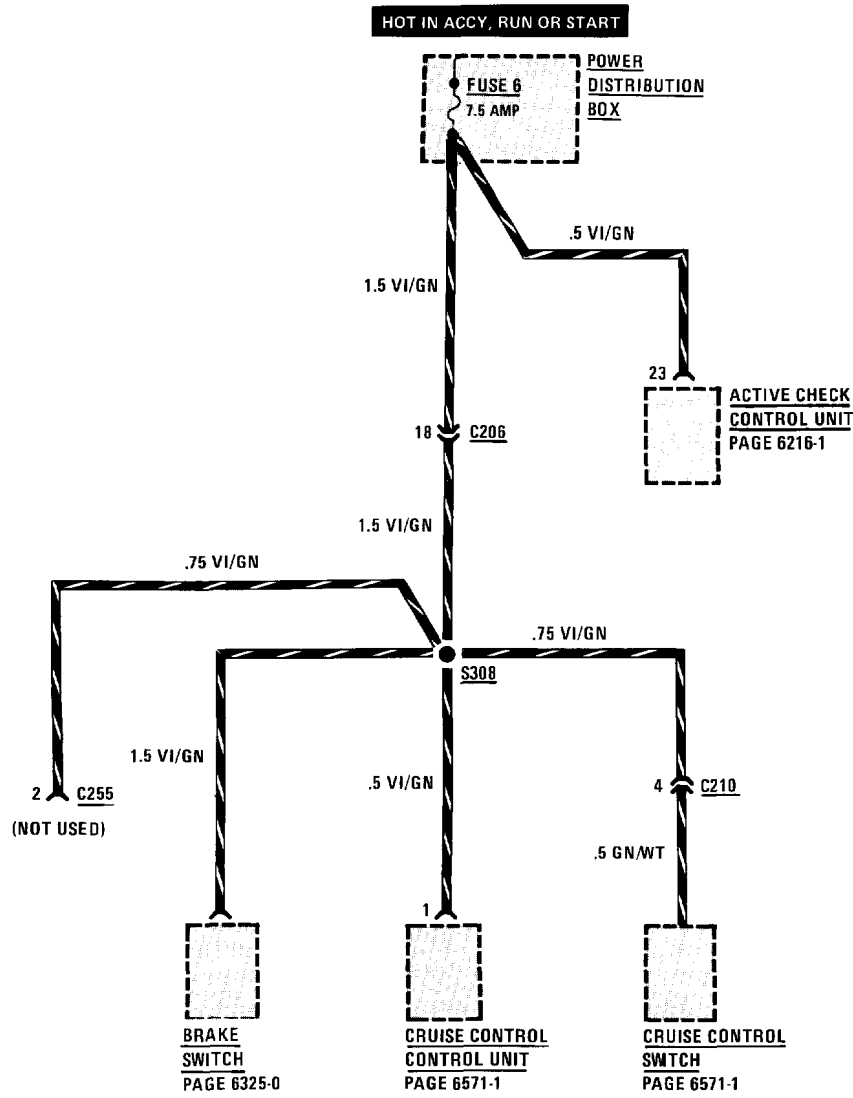



FUSE DETAILS: FUSE 21

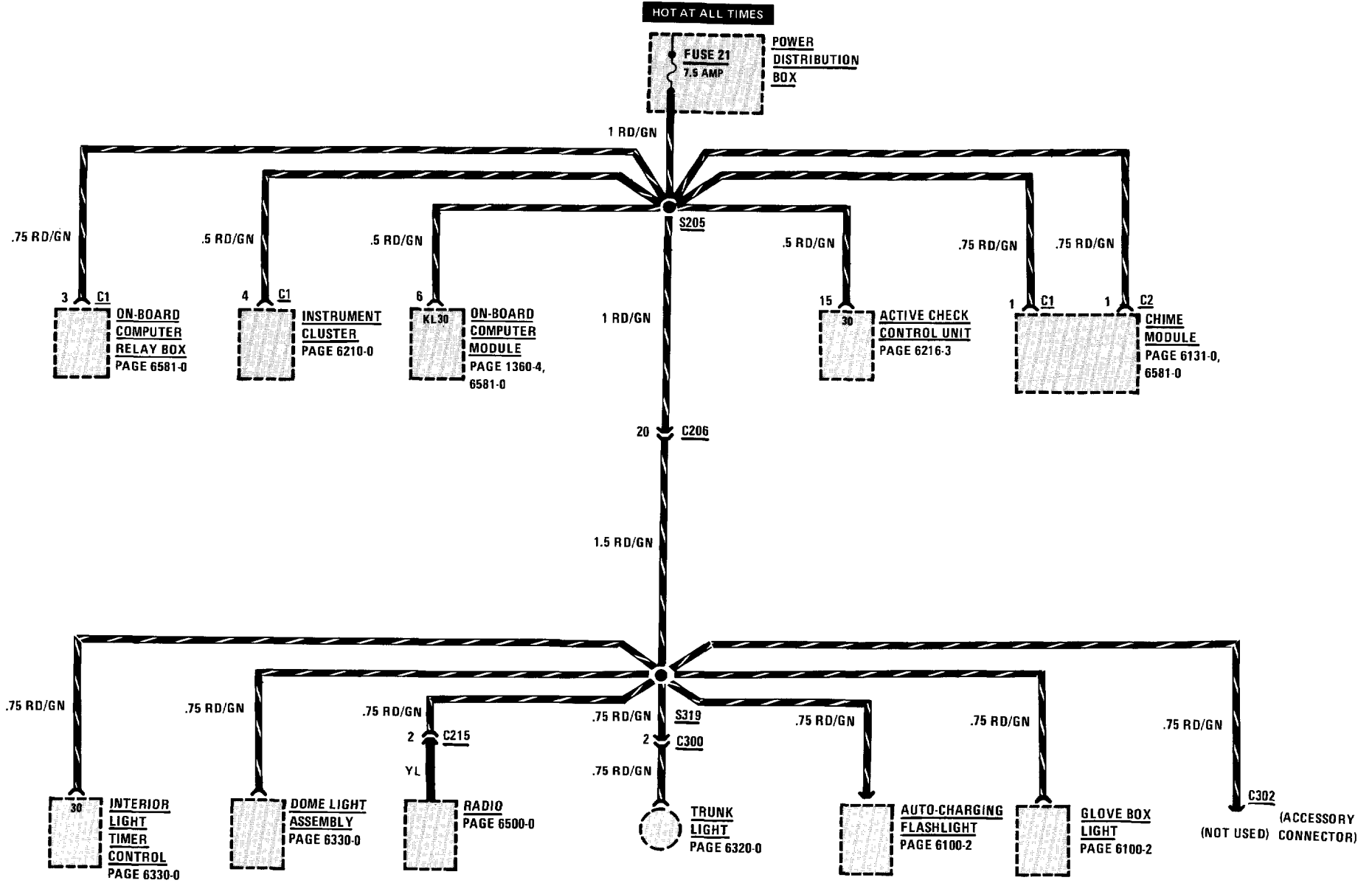

# 0670-12 POWER DISTRIBUTION S38 ENGINE

## GROUND DISTRIBUTION (G103 AND G104)

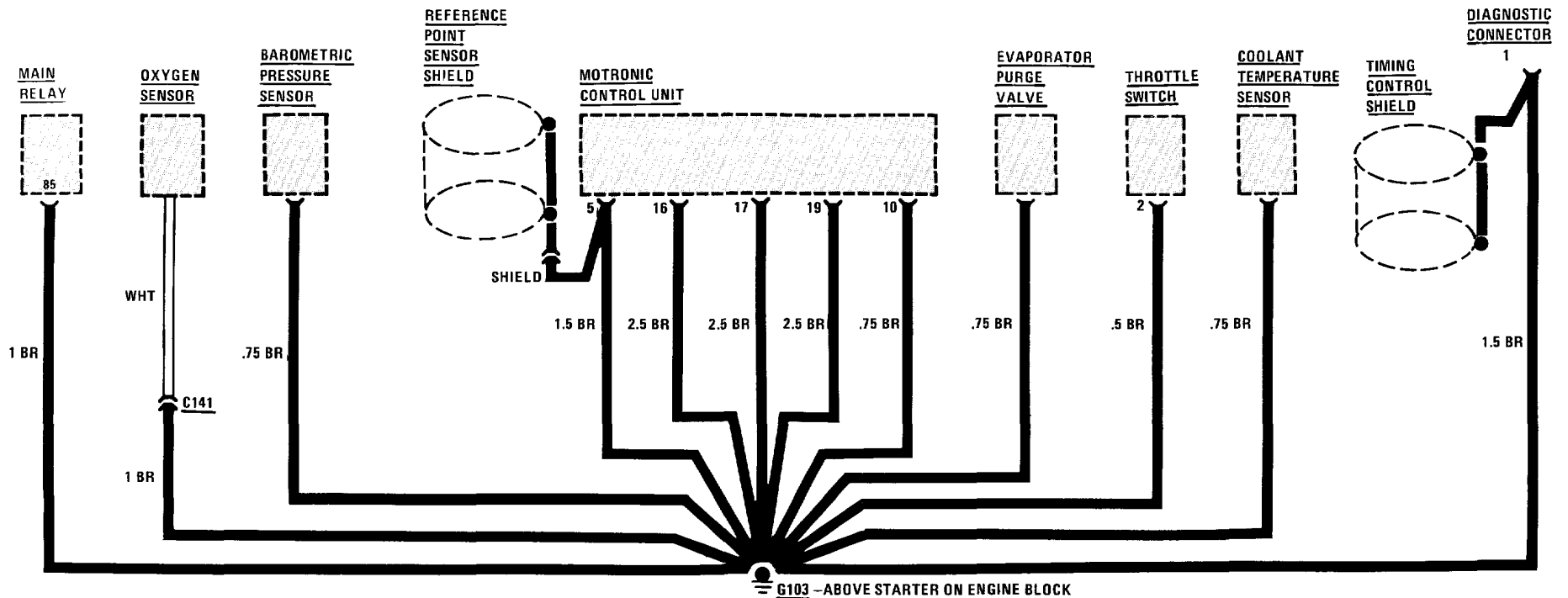
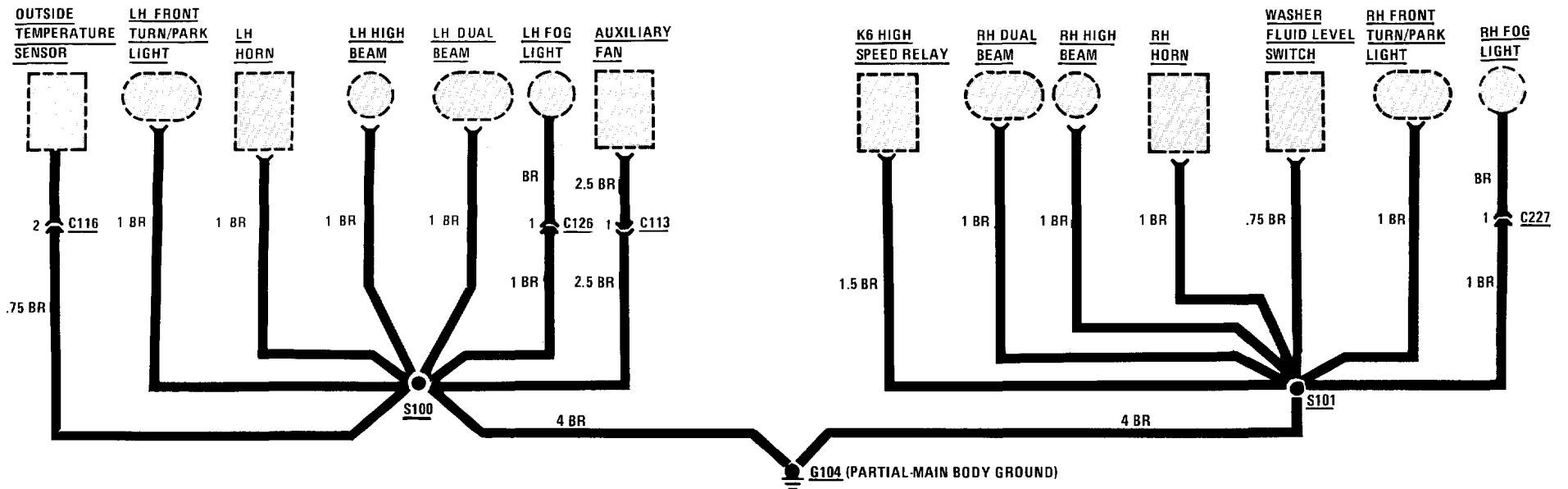

# 3.5i ENGINE POWER DISTRIBUTION 0670-13

## GROUND DISTRIBUTION (G103 AND G104)

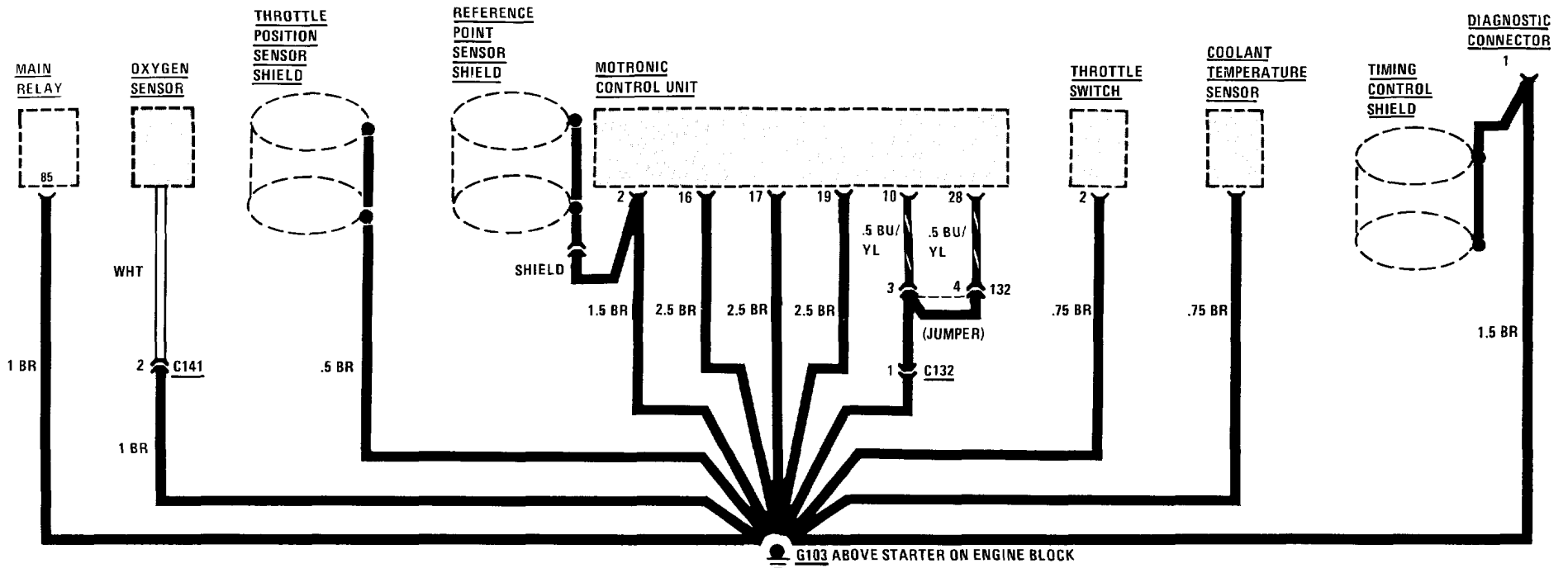
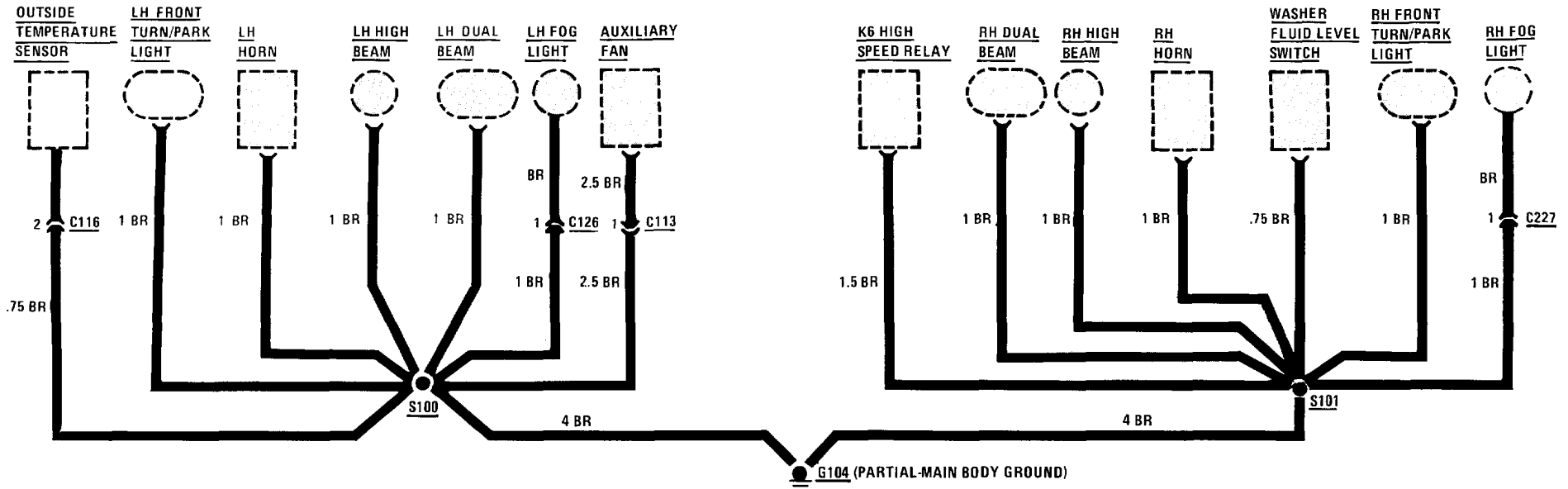

# 0670-14 POWER DISTRIBUTION 3.5i ENGINE

## GROUND DISTRIBUTION (G101 AND G104) ELECTRONIC TRANSMISSION

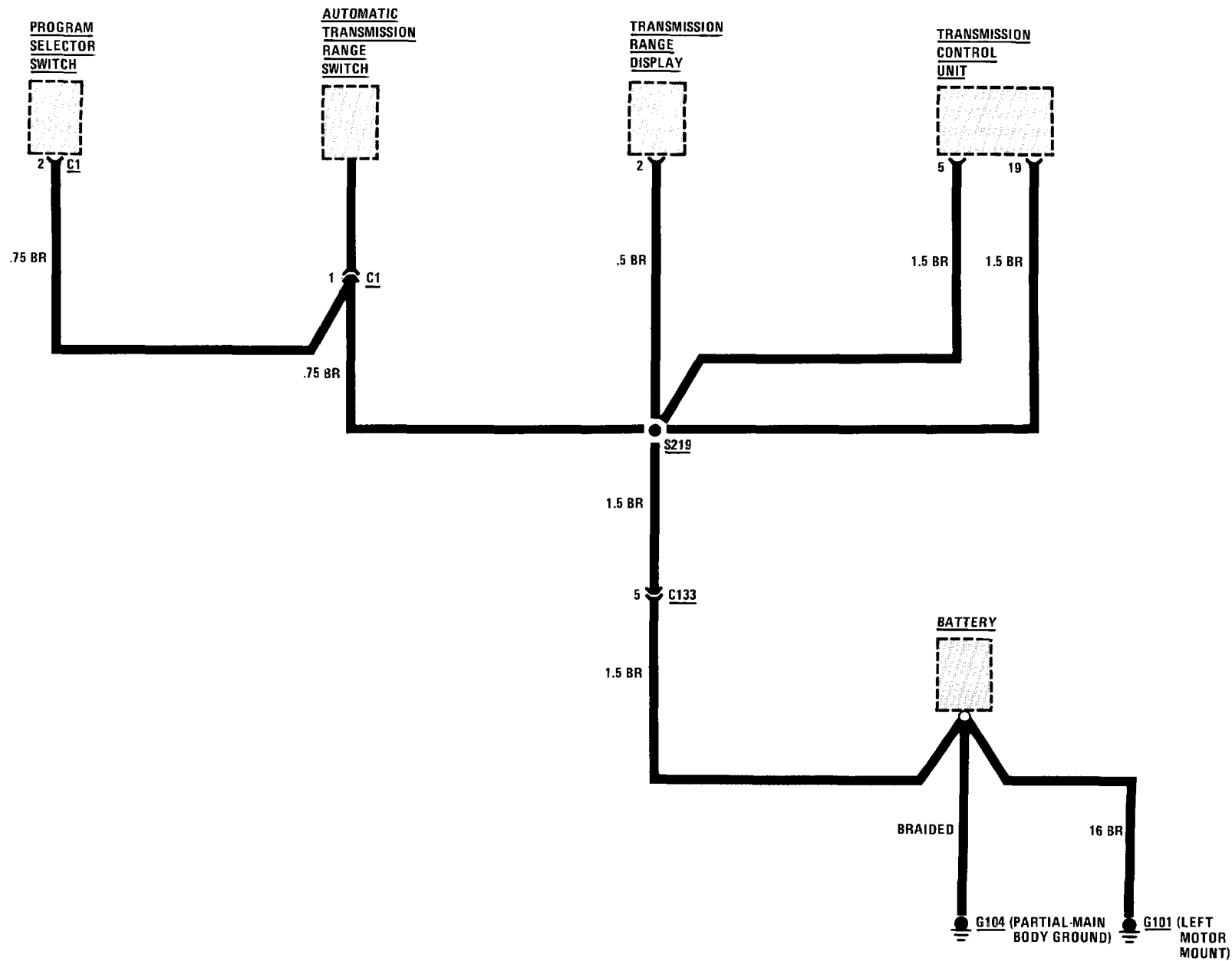

GROUND DISTRIBUTION (G200 AND G104)

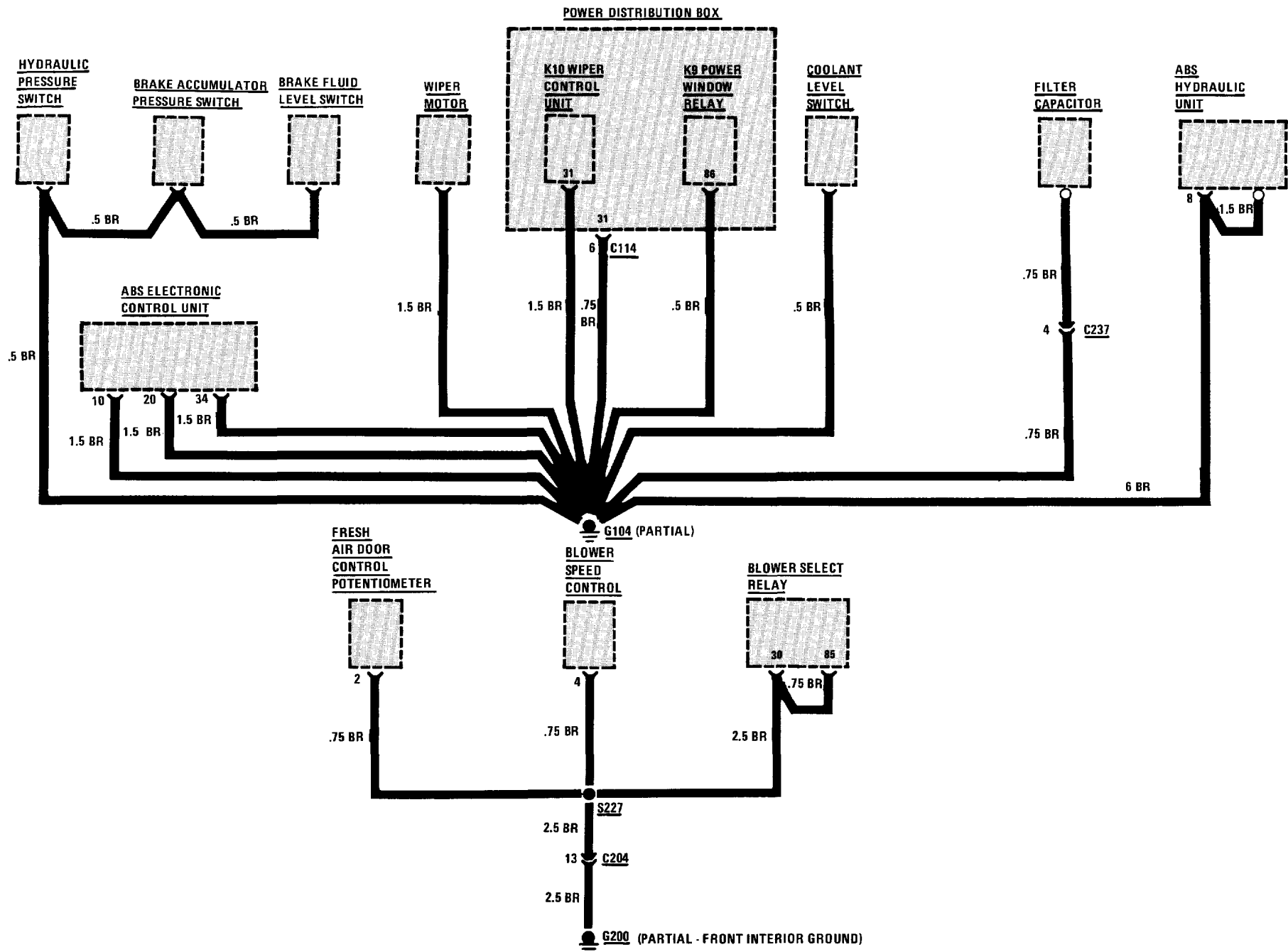

# 0670-16 POWER DISTRIBUTION

## GROUND DISTRIBUTION (G200)

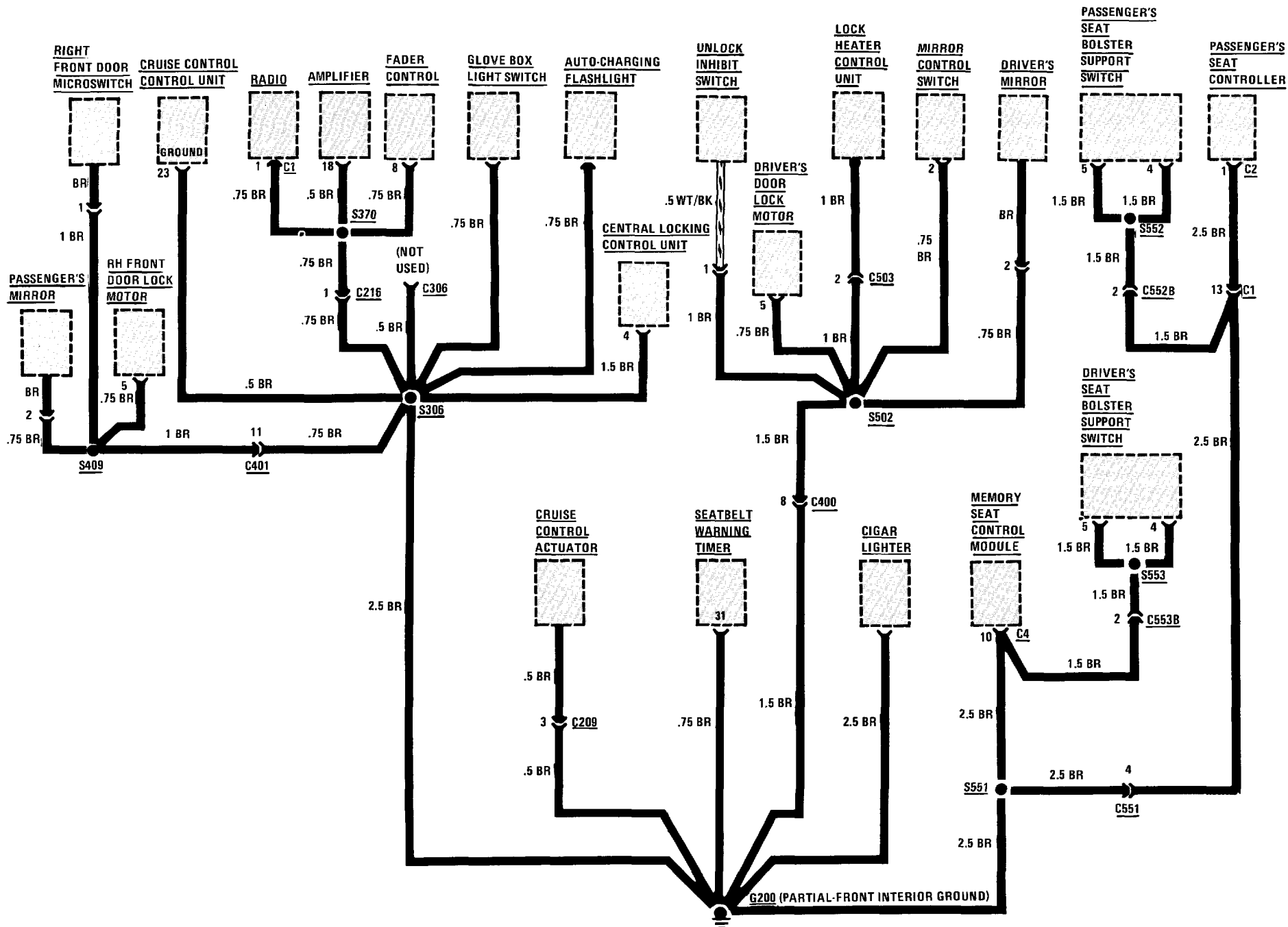

GROUND DISTRIBUTION (G200 AND G201)

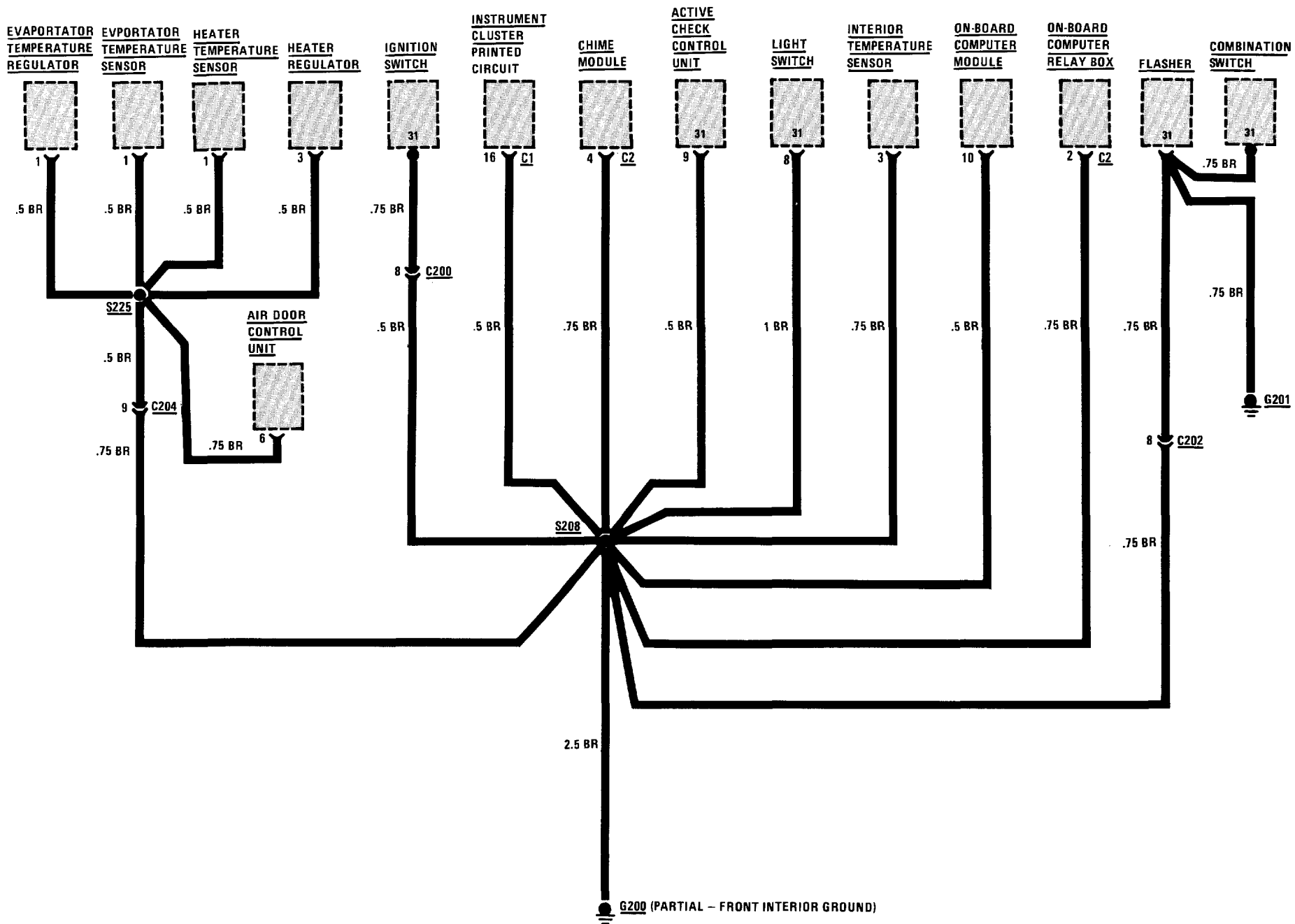

# 0670-18 POWER DISTRIBUTION

## GROUND DISTRIBUTION (G302)

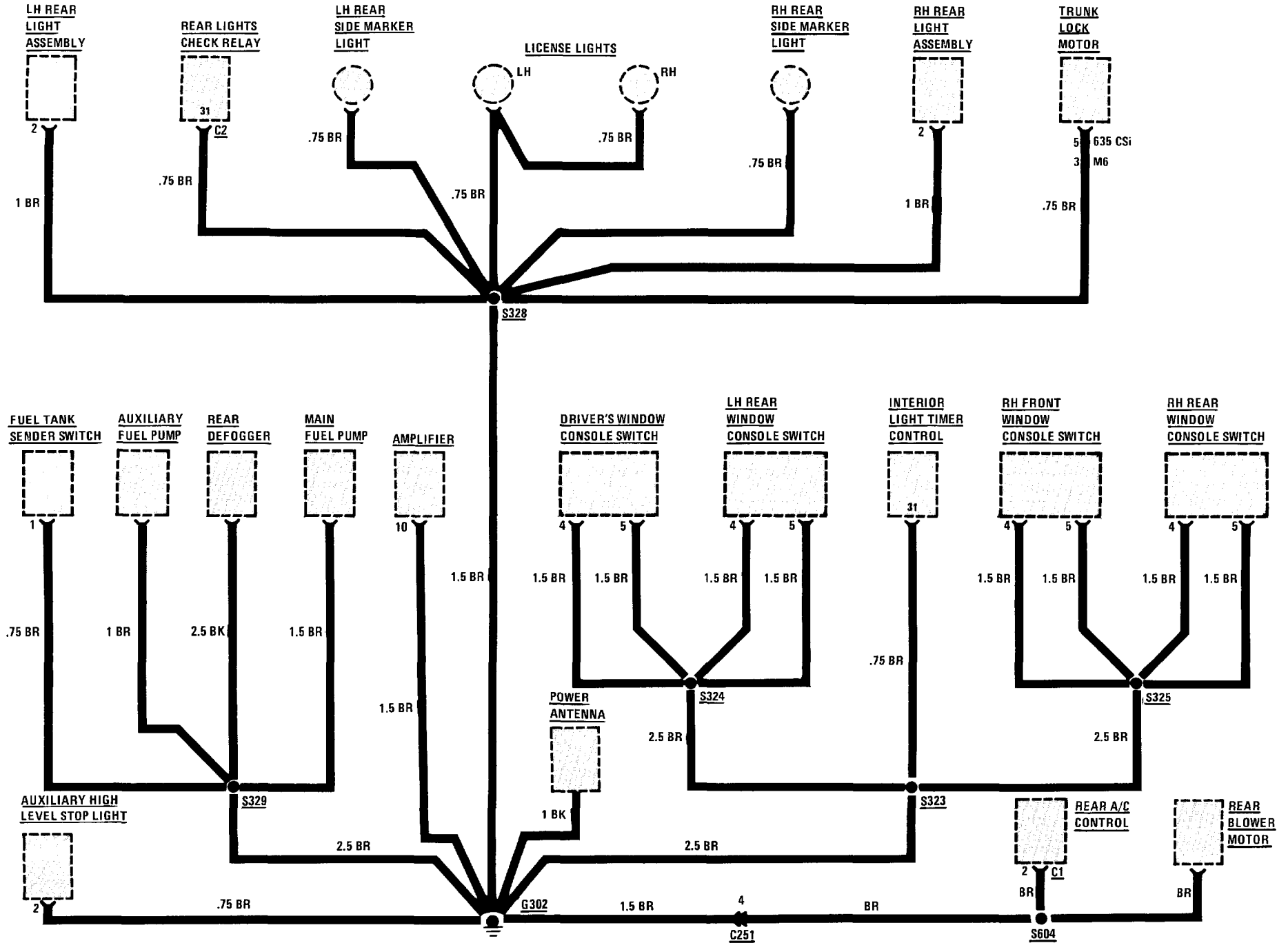



# 1230-0 CHARGING SYSTEM 3.5i ENGINE

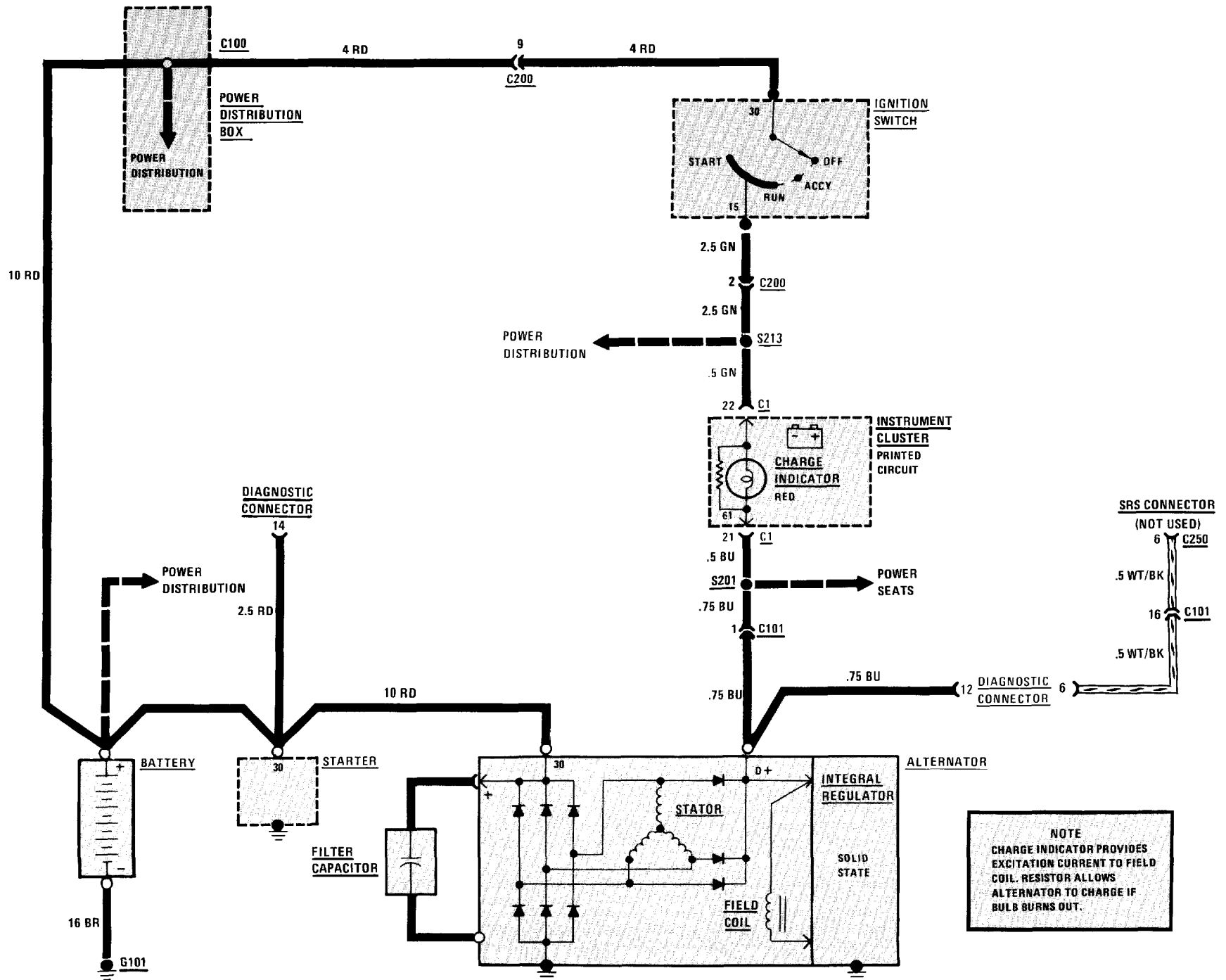

# S38 ENGINE CHARGING SYSTEM 1230-1

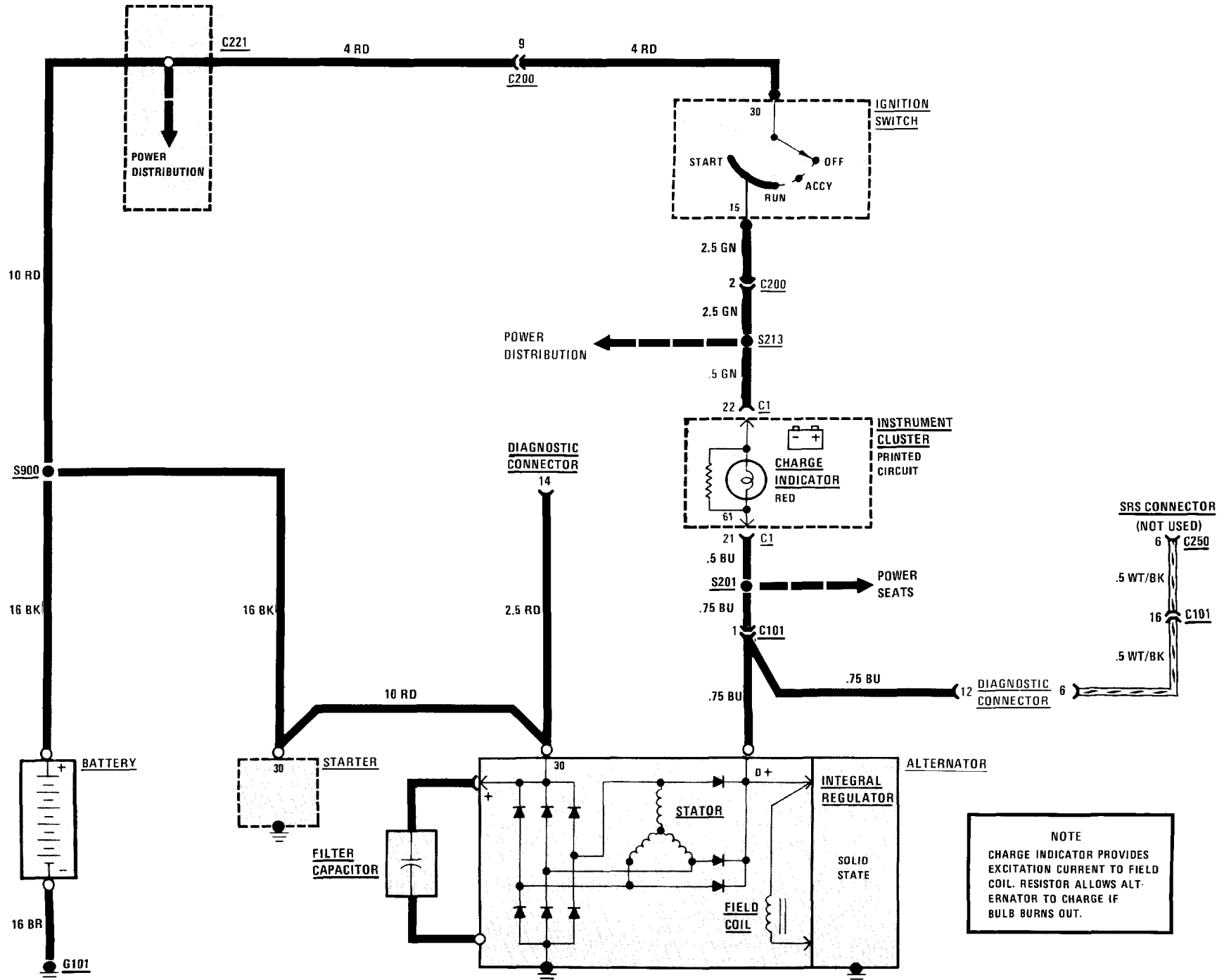

**NOTE**  
 CHARGE INDICATOR PROVIDES  
 EXCITATION CURRENT TO FIELD  
 COIL. RESISTOR ALLOWS ALT-  
 ERNATOR TO CHARGE IF  
 BULB BURNS OUT.

# 1240-0 START 3.5i ENGINE

## ELECTRONIC TRANSMISSION

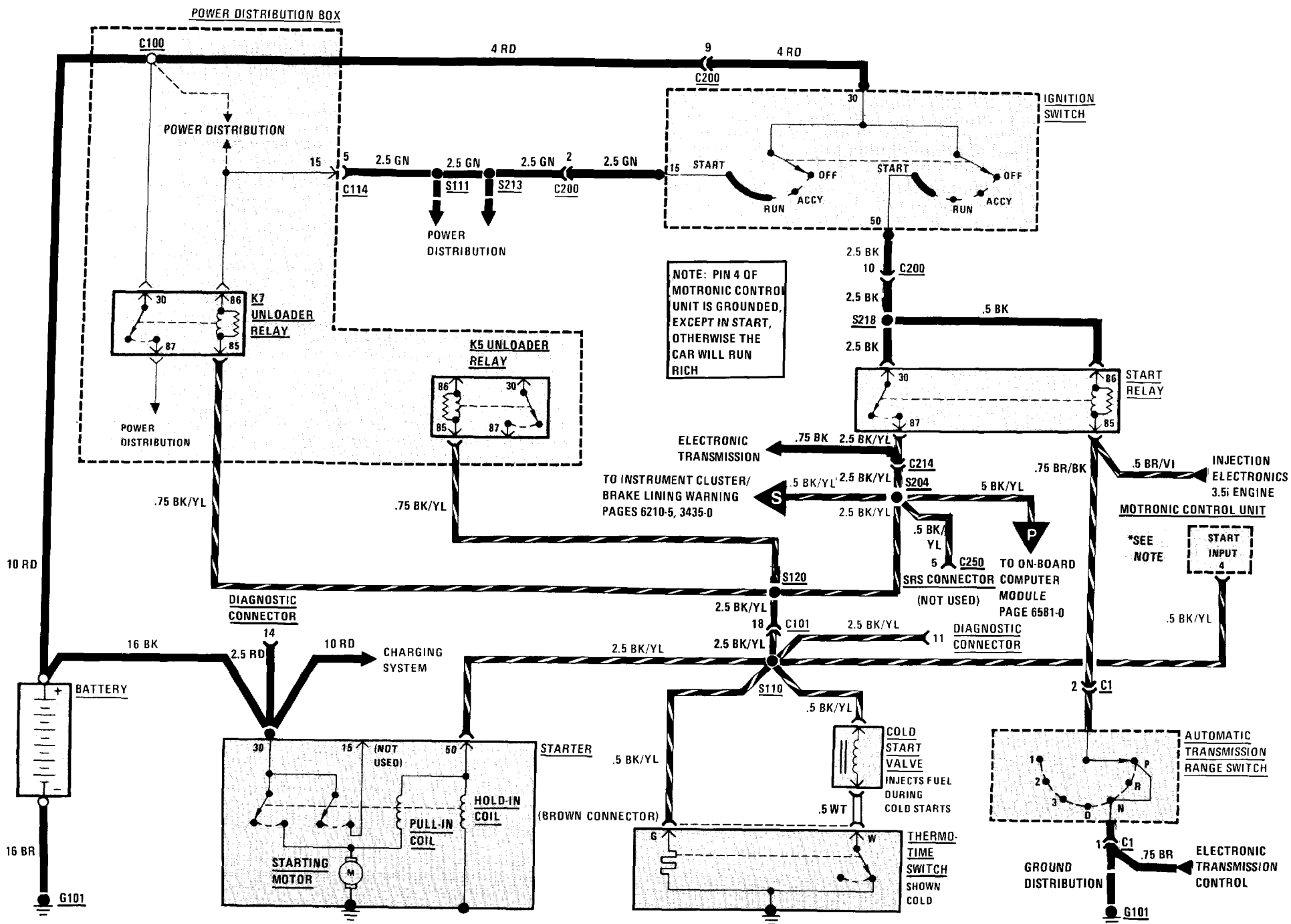

MANUAL TRANSMISSION

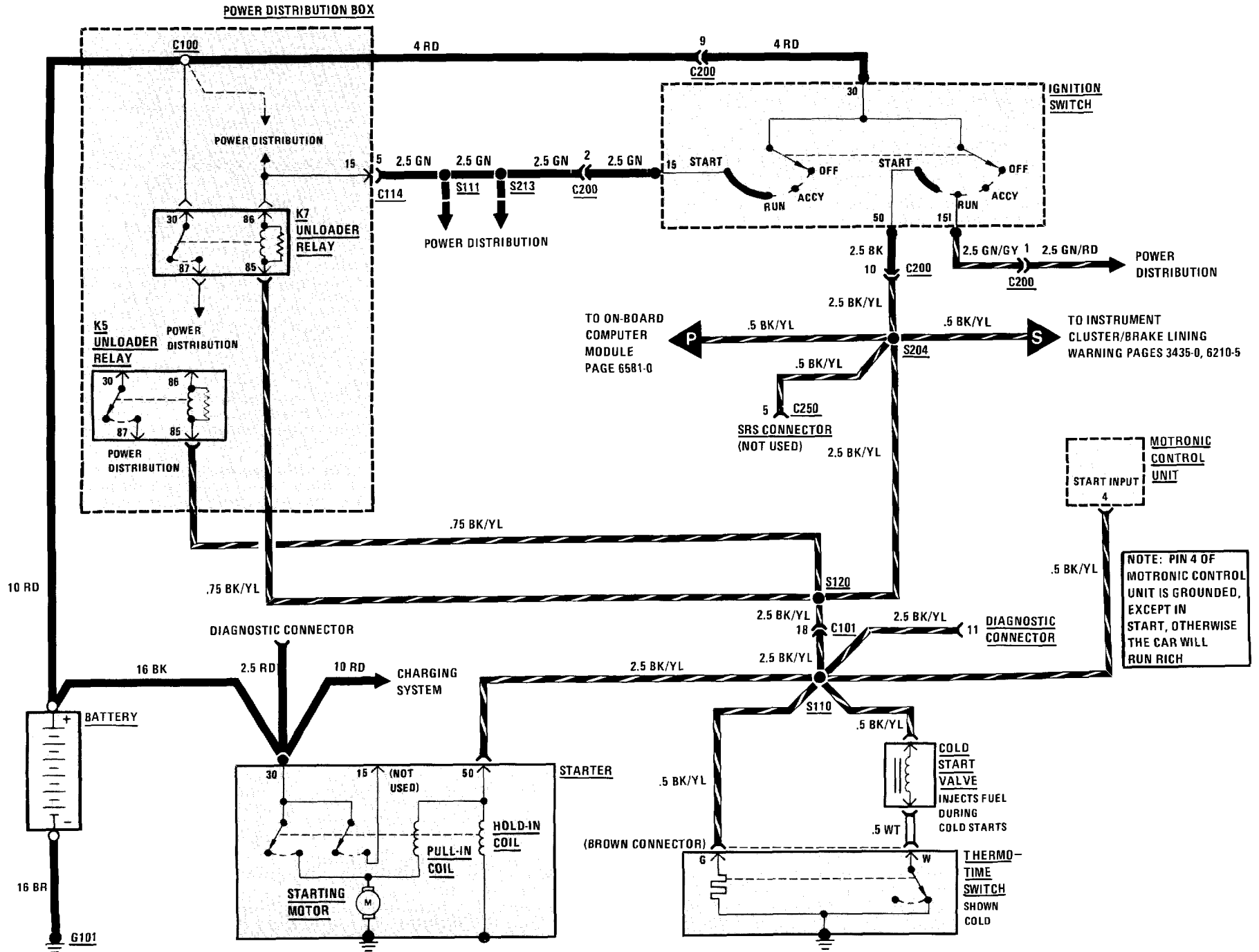

# 1240-2 START S38 ENGINE

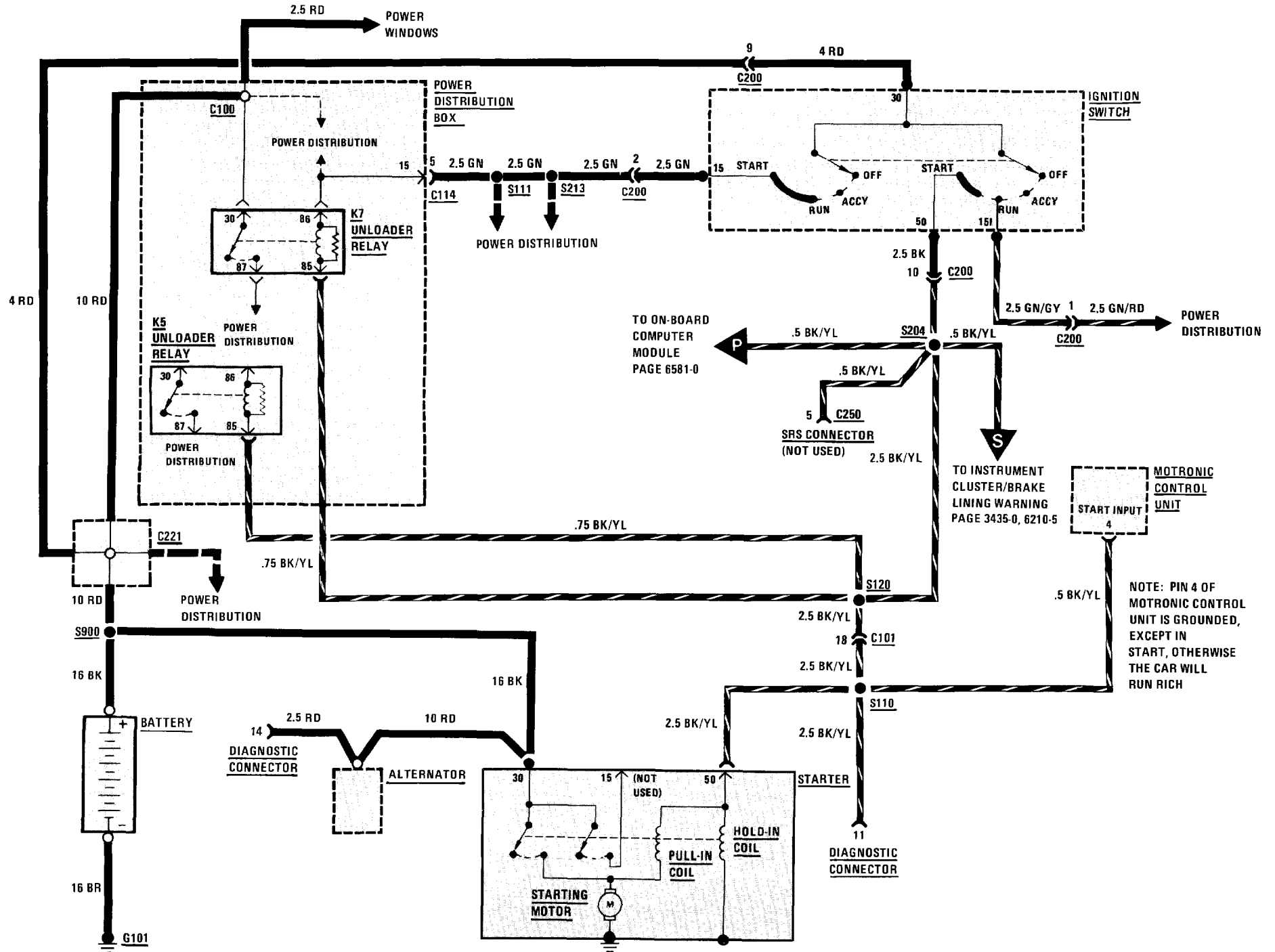

# 1360-0 INJECTION ELECTRONICS 3.5i ENGINE

## ENGINE BLOCK DIAGRAM ELECTRONIC TRANSMISSION

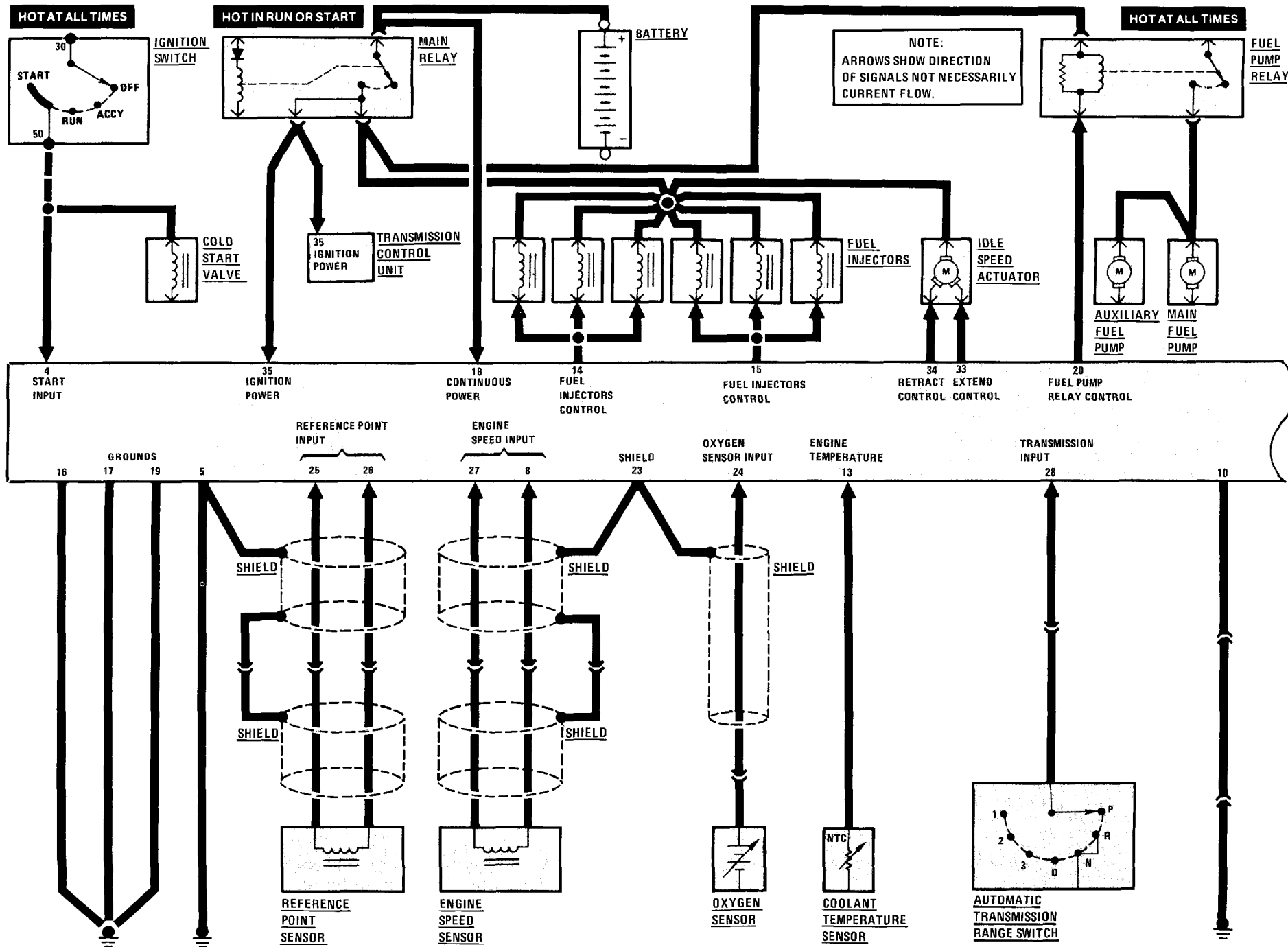

ENGINE BLOCK DIAGRAM ELECTRONIC TRANSMISSION

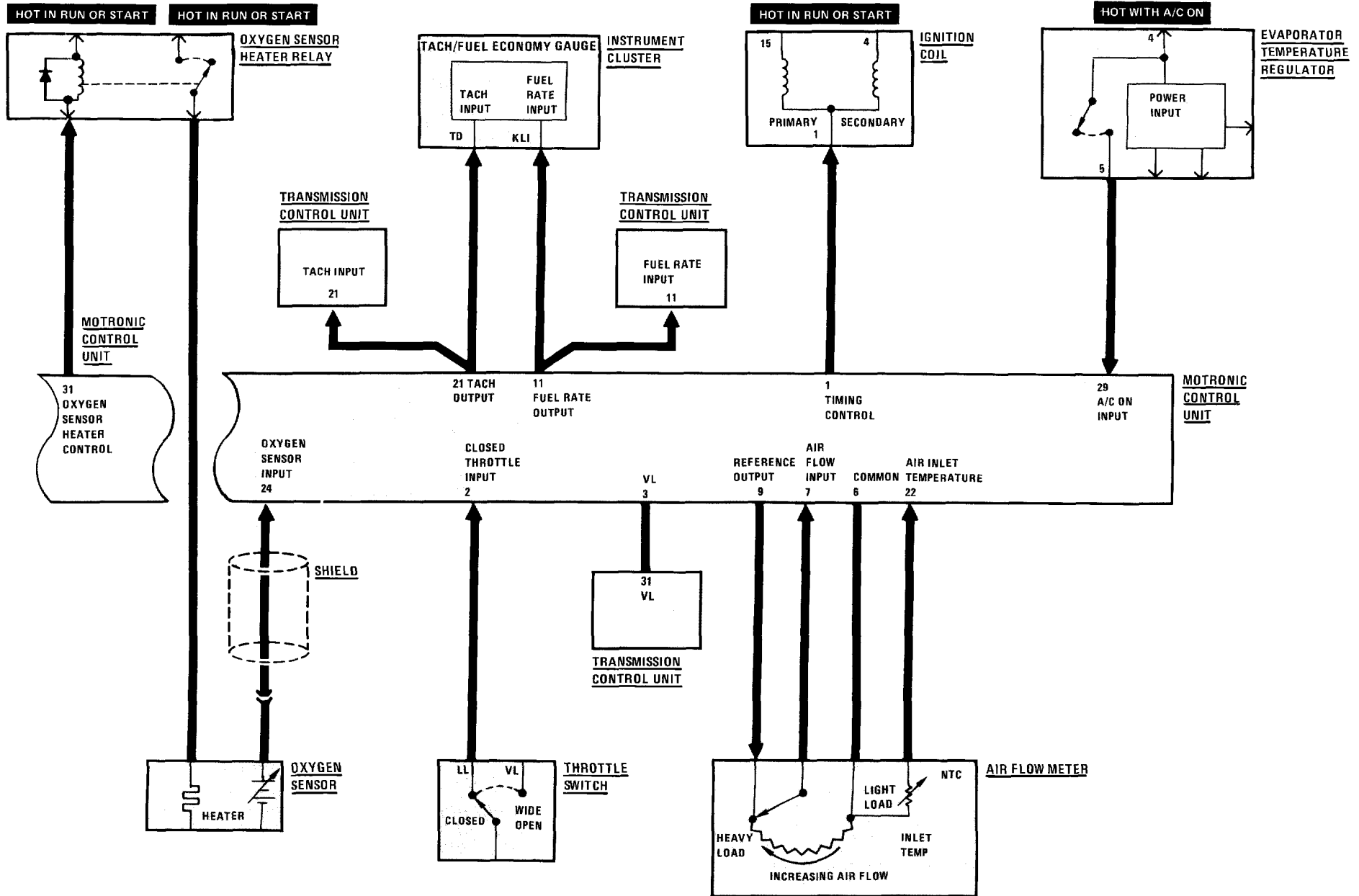

# 1360-2 INJECTION ELECTRONICS 3.5i ENGINE

## ENGINE BLOCK DIAGRAM MANUAL TRANSMISSION

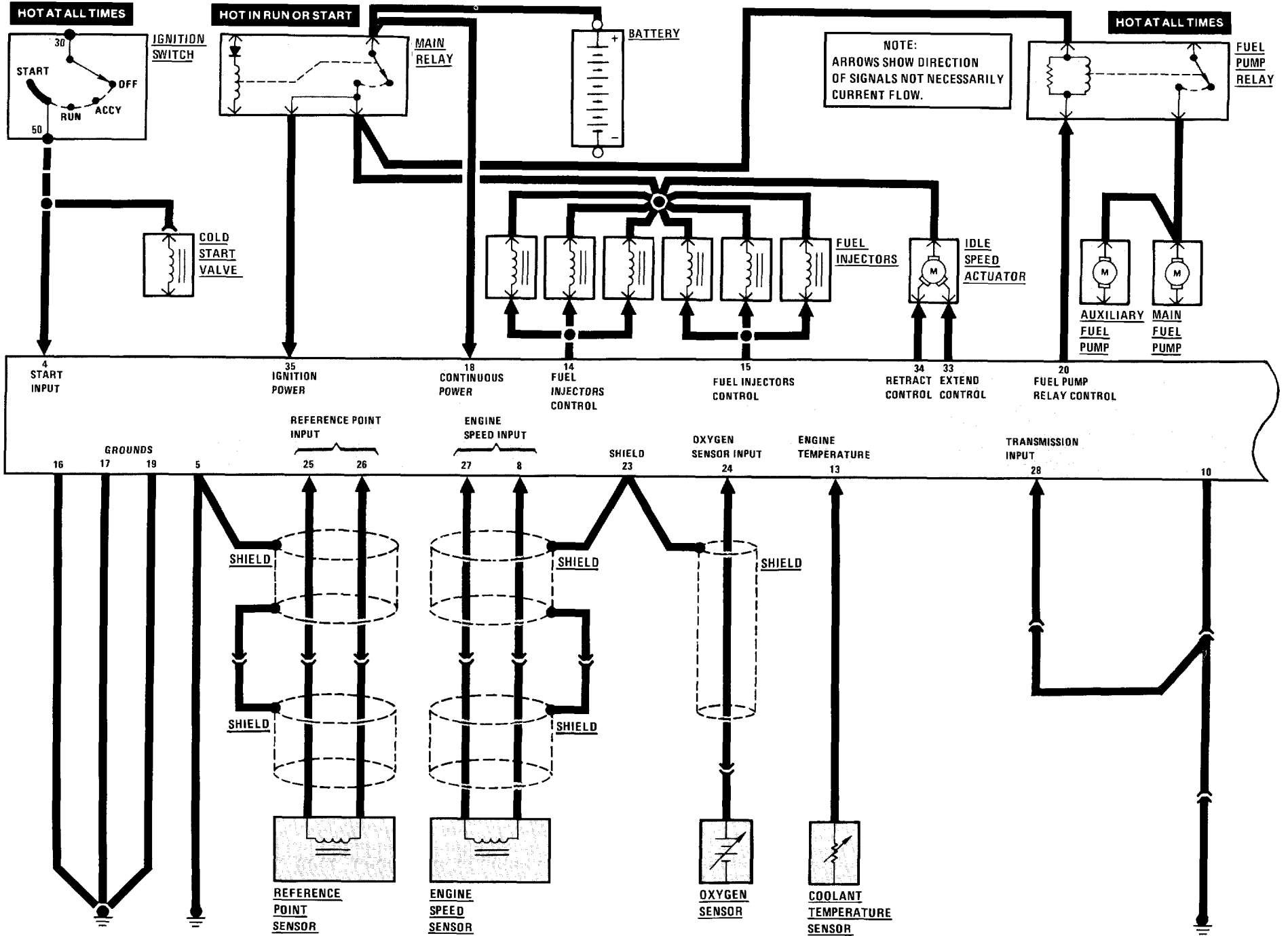



ENGINE BLOCK DIAGRAM MANUAL TRANSMISSION

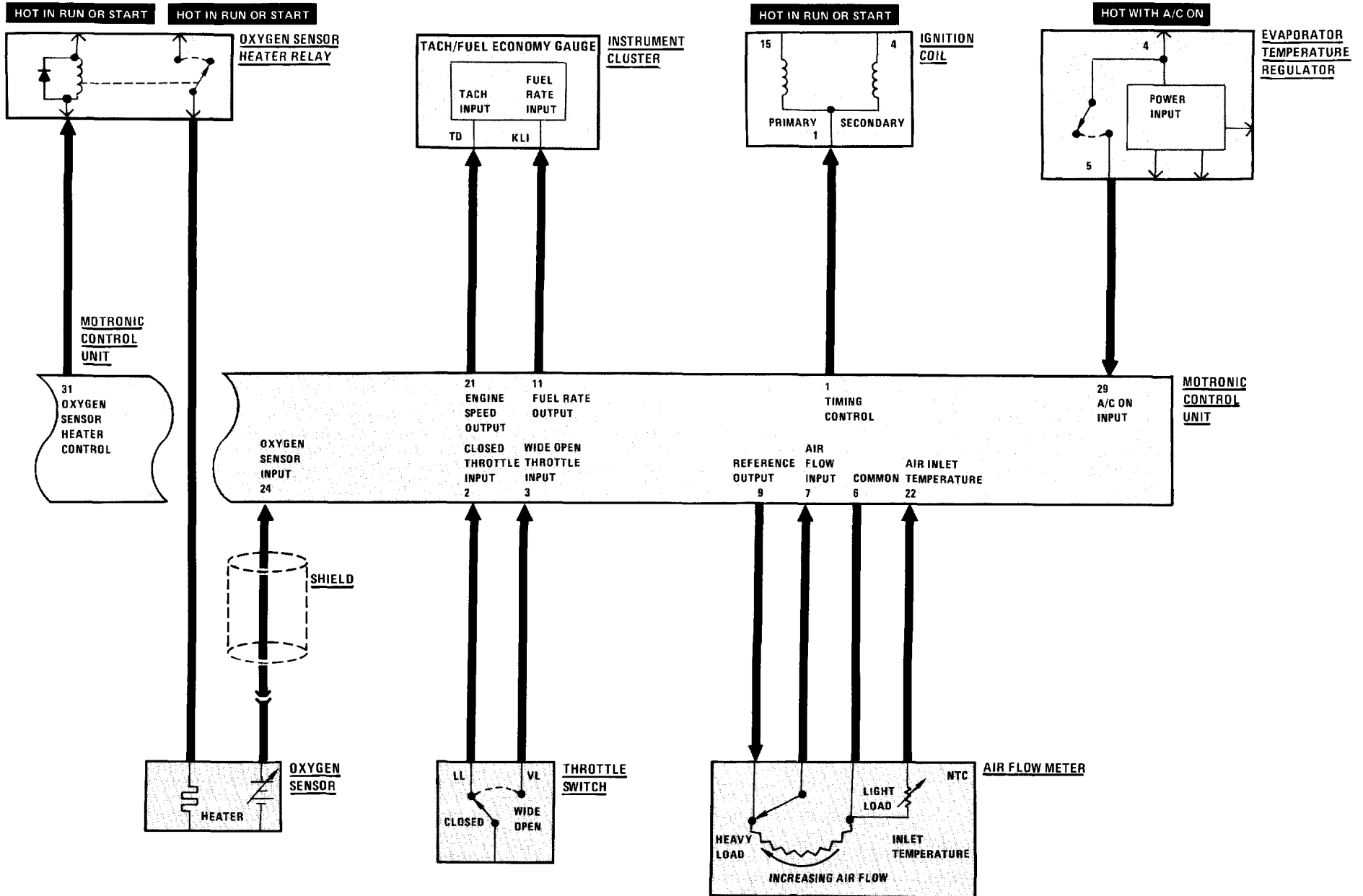

**ELECTRONIC TRANSMISSION/FUEL DELIVERY/FUEL CONTROL**

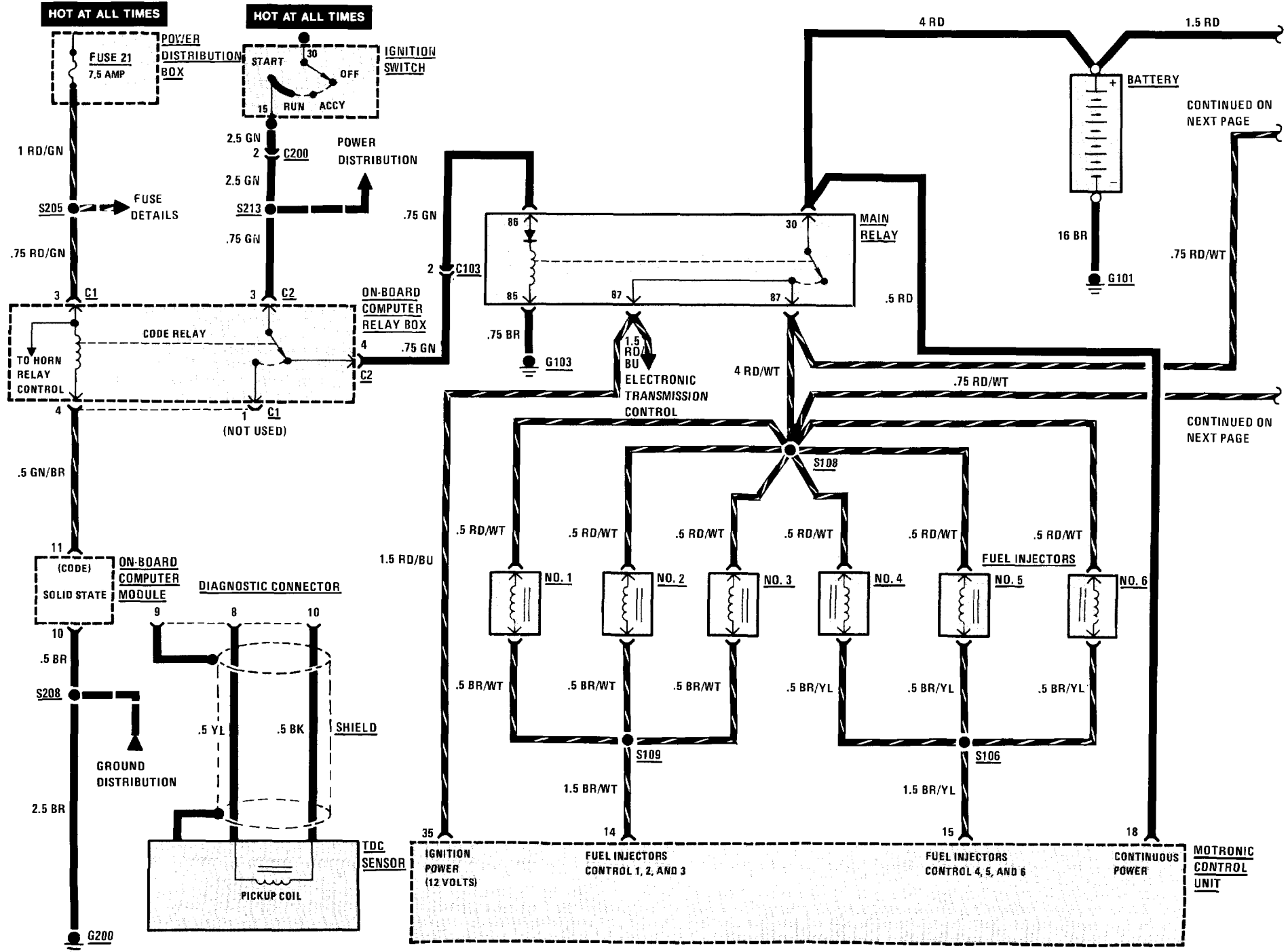

CONTINUED ON NEXT PAGE

CONTINUED ON NEXT PAGE

**ELECTRONIC TRANSMISSION/FUEL DELIVERY/FUEL CONTROL/IDLE SPEED CONTROL**

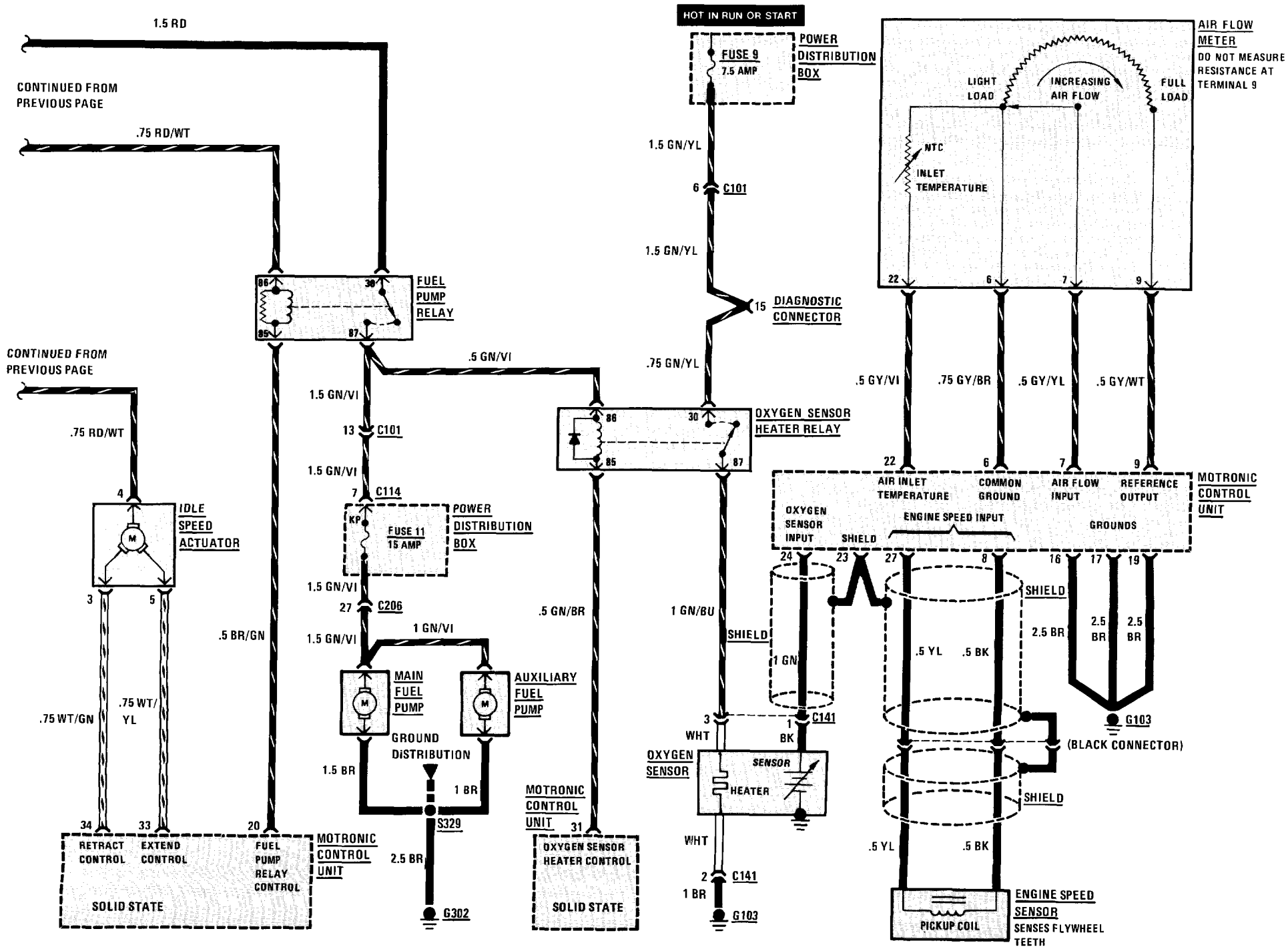

CONTINUED FROM PREVIOUS PAGE

1.5 RD

.75 RD/WT

CONTINUED FROM PREVIOUS PAGE

.75 RD/WT

.75 WT/GN

.5 BR/GN

1.5 GN/YL

6 C101

1.5 GN/YL

.75 GN/YL

.5 GN/VI

1.5 GN/VI

13 C101

1.5 GN/VI

7 C114

1.5 GN/VI

27 C206

1.5 GN/VI

1 GN/VI

.5 GN/BR

1 GN/BU

3 WHT

1 BK

3

2 C141

1 BR

.5 GY/VI

.75 GY/BR

.5 GY/YL

.5 GY/WT

AIR INLET TEMPERATURE

COMMON GROUND

AIR FLOW INPUT

REFERENCE OUTPUT

24

23

27

8

16

17

19

OXYGEN SENSOR INPUT

SHIELD

ENGINE SPEED INPUT

SHIELD

SHIELD

SHIELD

.5 YL

.5 BK

3

1

.5 YL

.5 BK

ENGINE SPEED SENSOR

PICKUP COIL

SENSES FLYWHEEL TEETH

AIR FLOW METER

DO NOT MEASURE RESISTANCE AT TERMINAL 9

# 1360-6 INJECTION ELECTRONICS 3.5i ENGINE

## ELECTRONIC TRANSMISSION/IGNITION/FUEL CONTROL

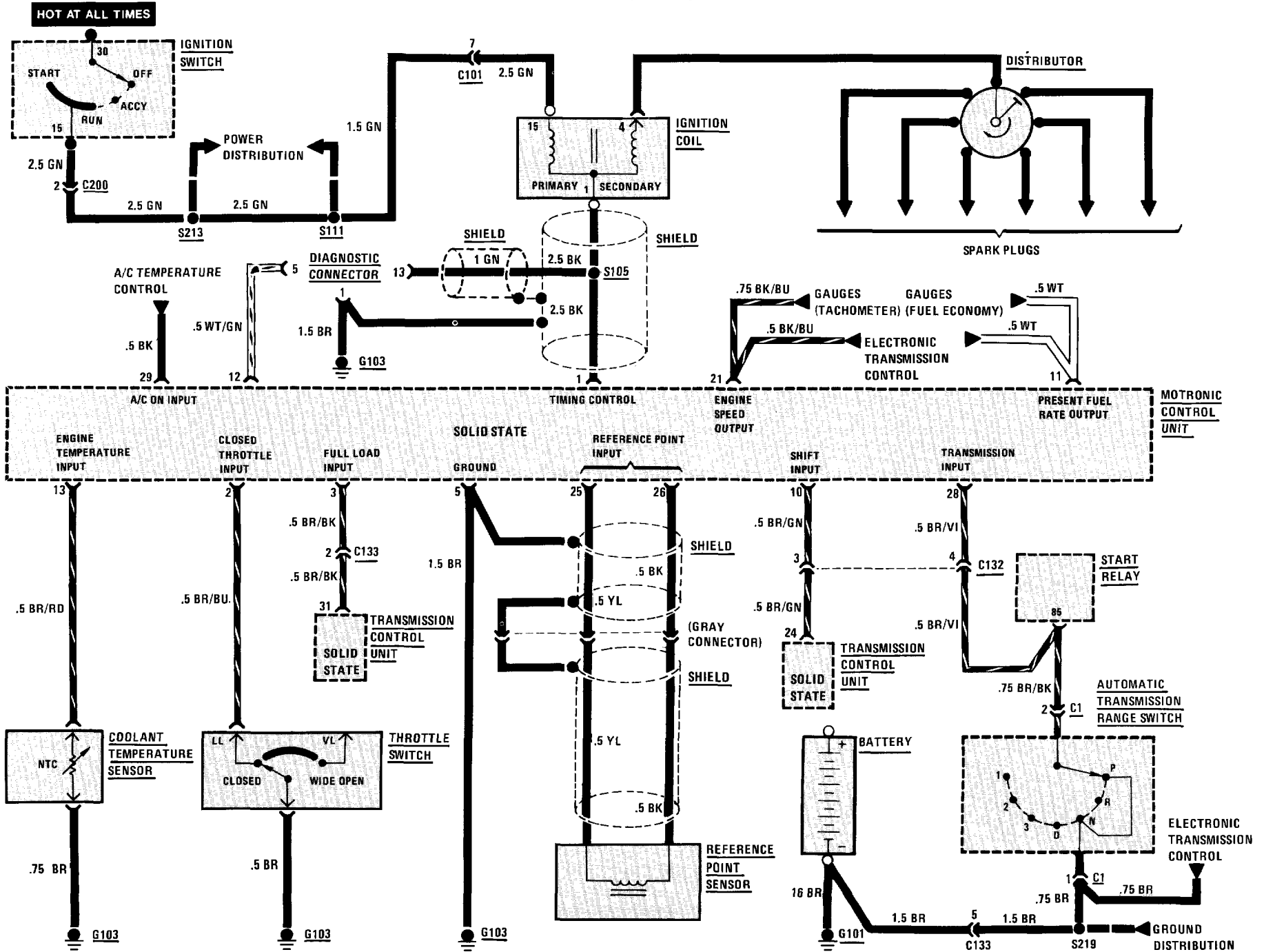

MANUAL TRANSMISSION/FUEL DELIVERY/FUEL CONTROL

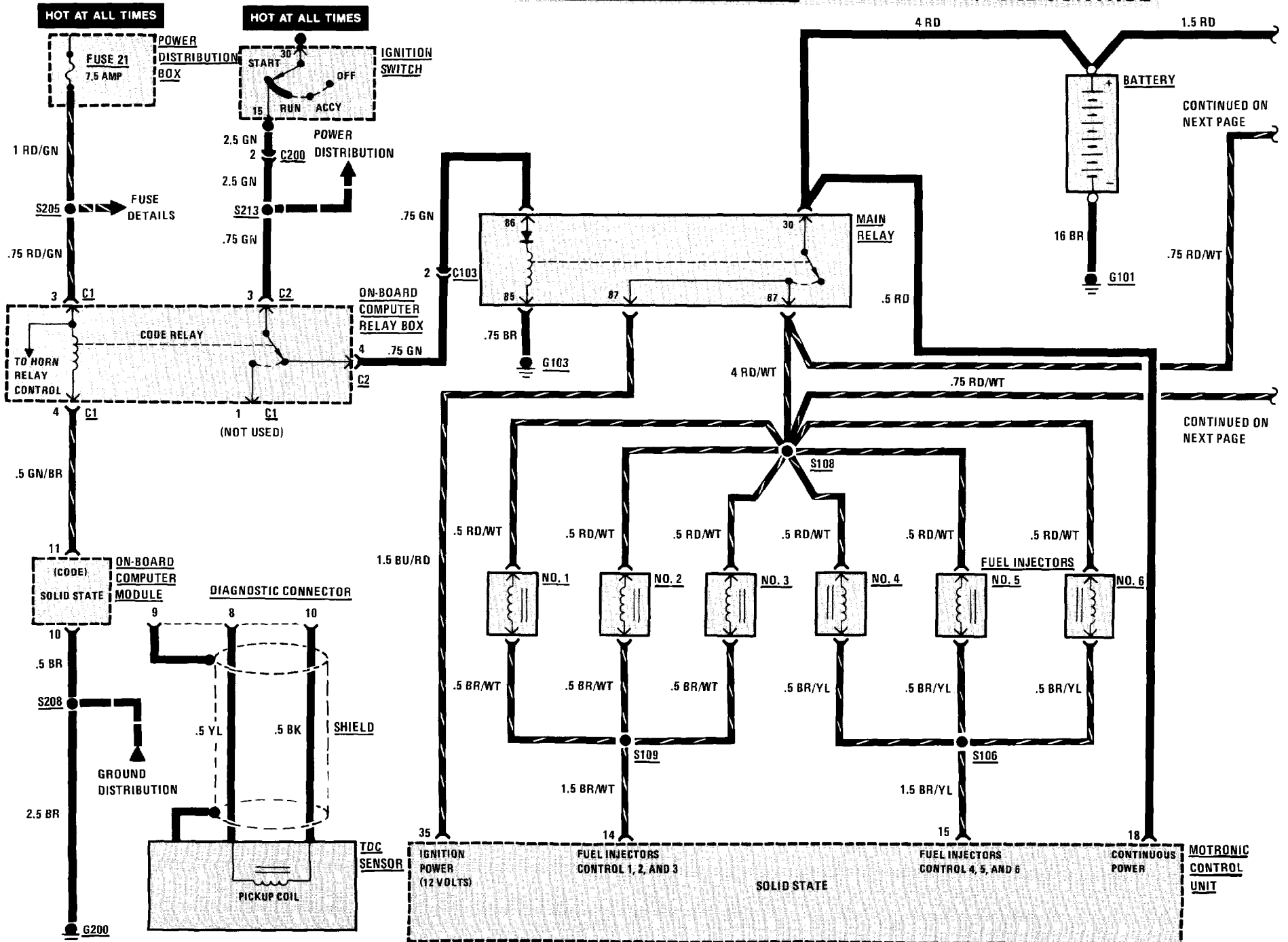

**1360-8 INJECTION ELECTRONICS 3.5i ENGINE**

**MANUAL TRANSMISSION/FUEL DELIVERY/FUEL CONTROL/IDLE SPEED CONTROL**

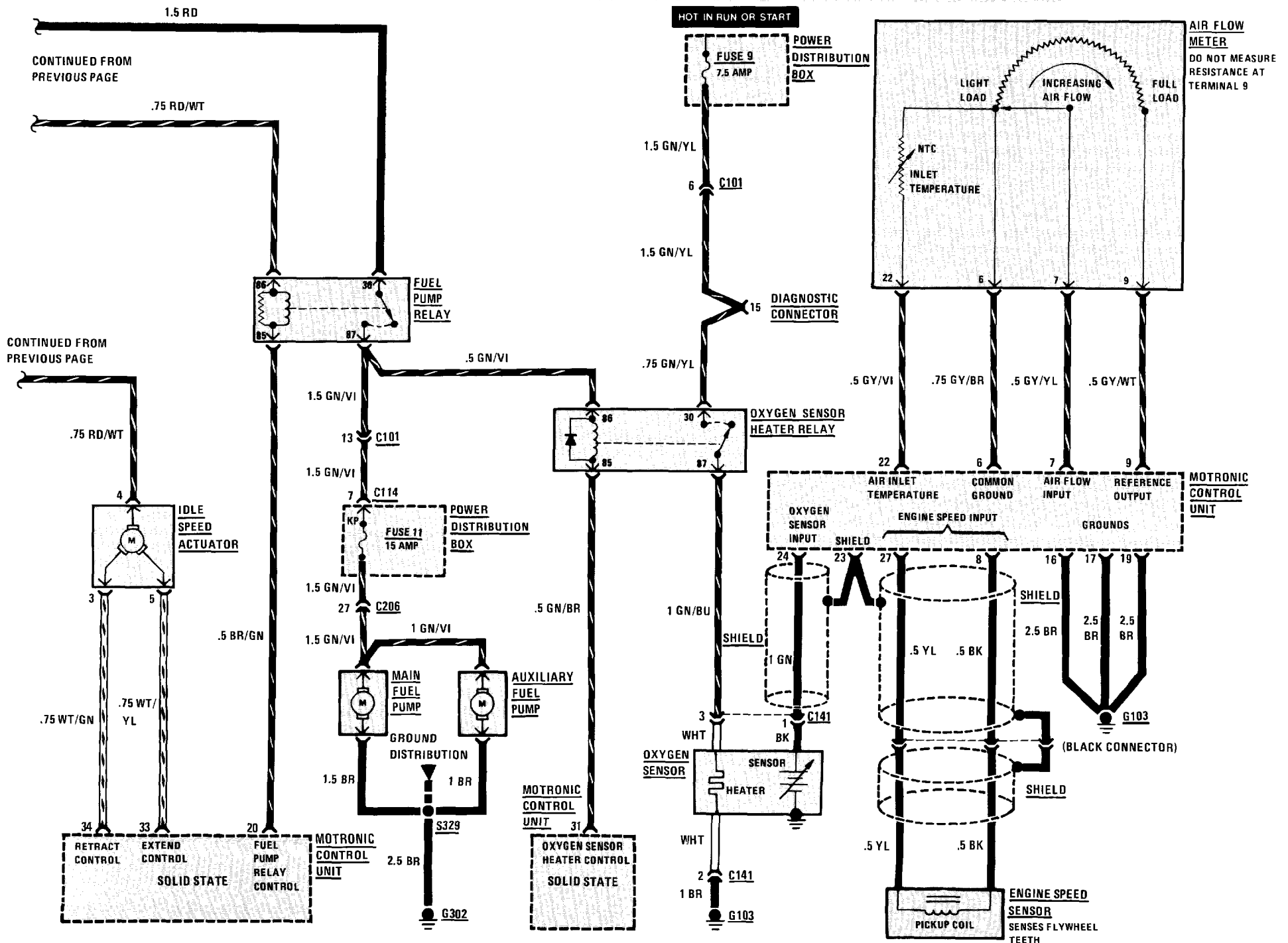

MANUAL TRANSMISSION/FUEL CONTROL/IGNITION

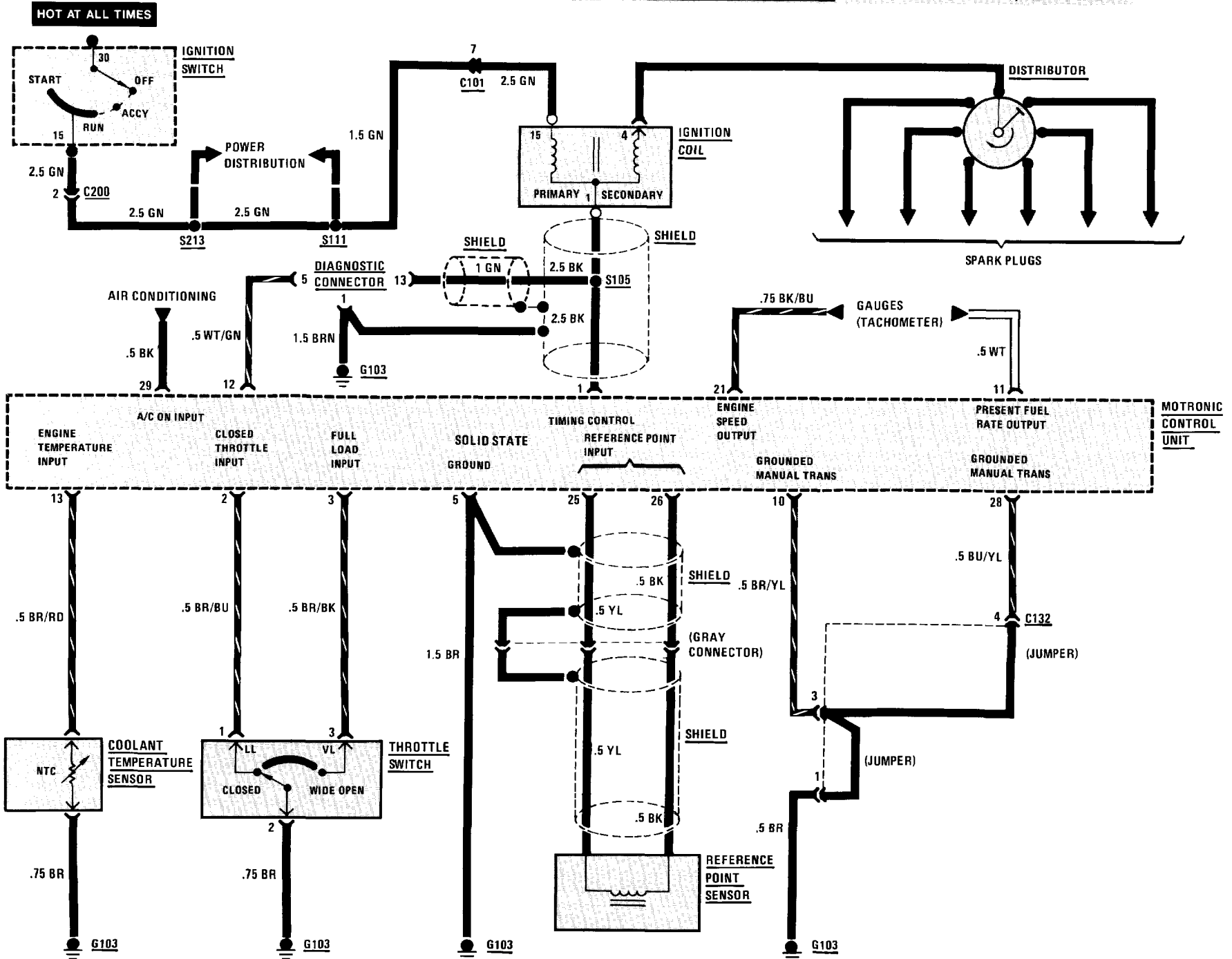

# 1362-0 INJECTION ELECTRONICS S38 ENGINE

## ENGINE BLOCK DIAGRAM

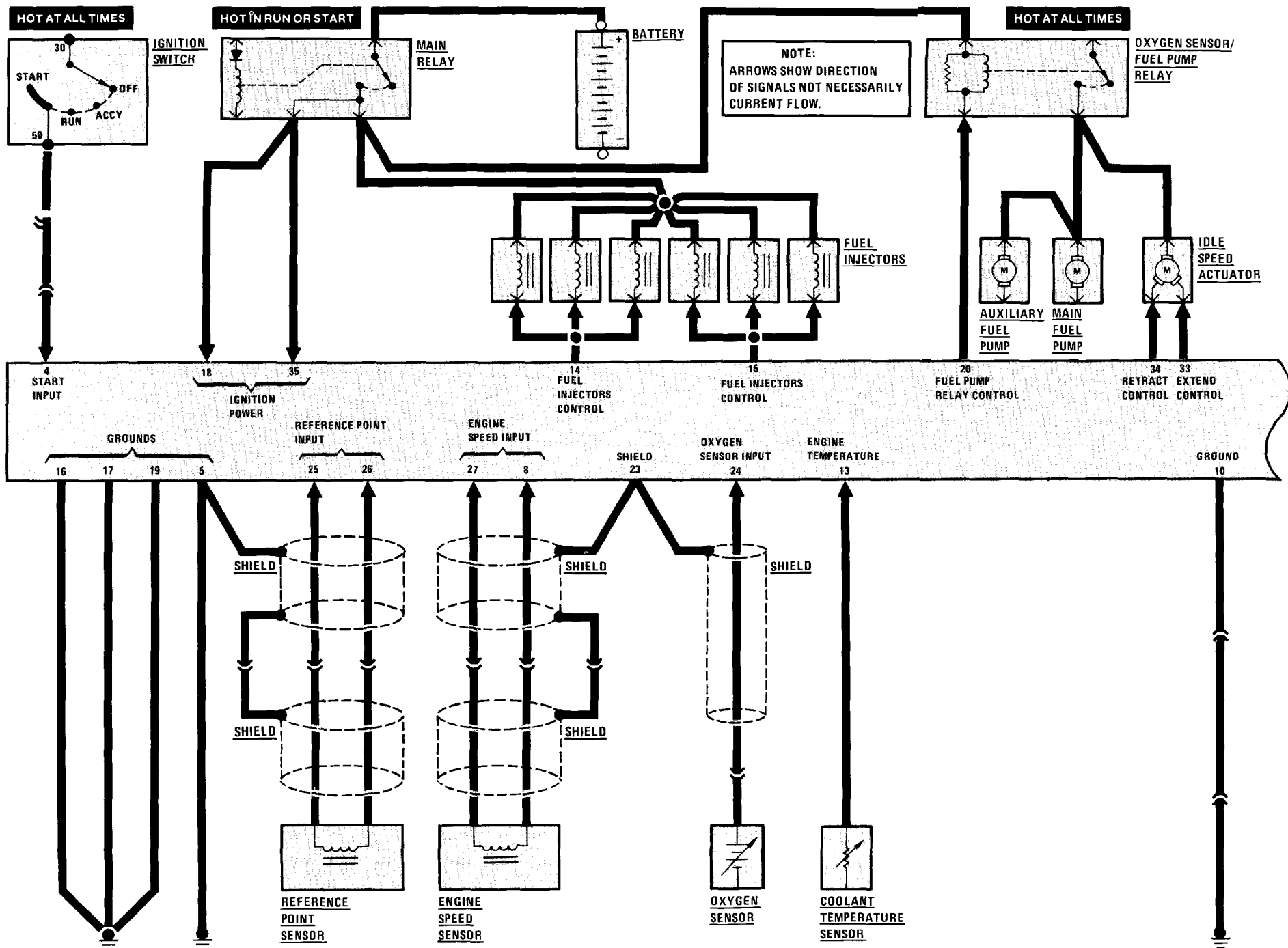



ENGINE BLOCK DIAGRAM

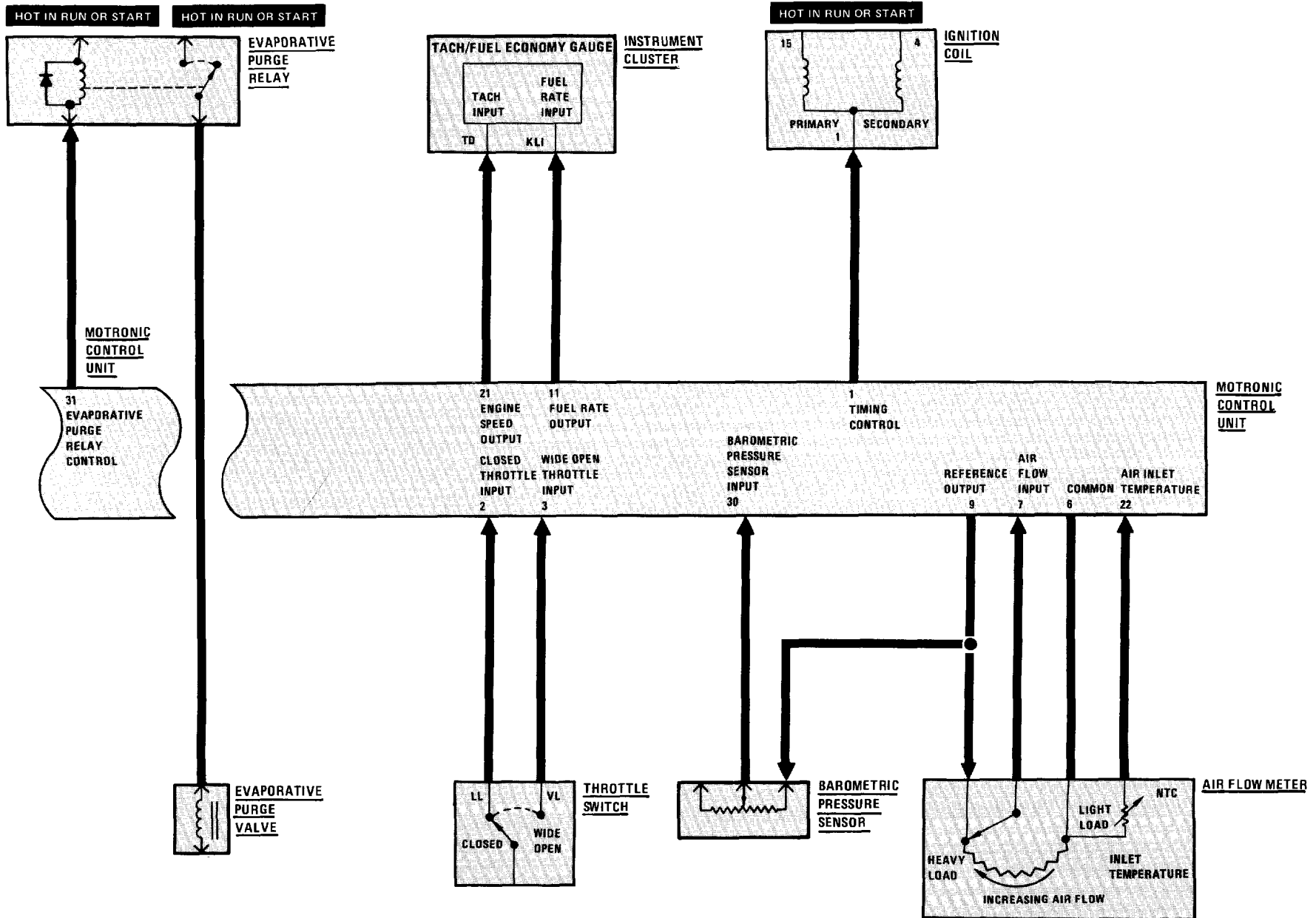

# 1362-2 INJECTION ELECTRONICS S38 ENGINE

## FUEL CONTROL/IGNITION

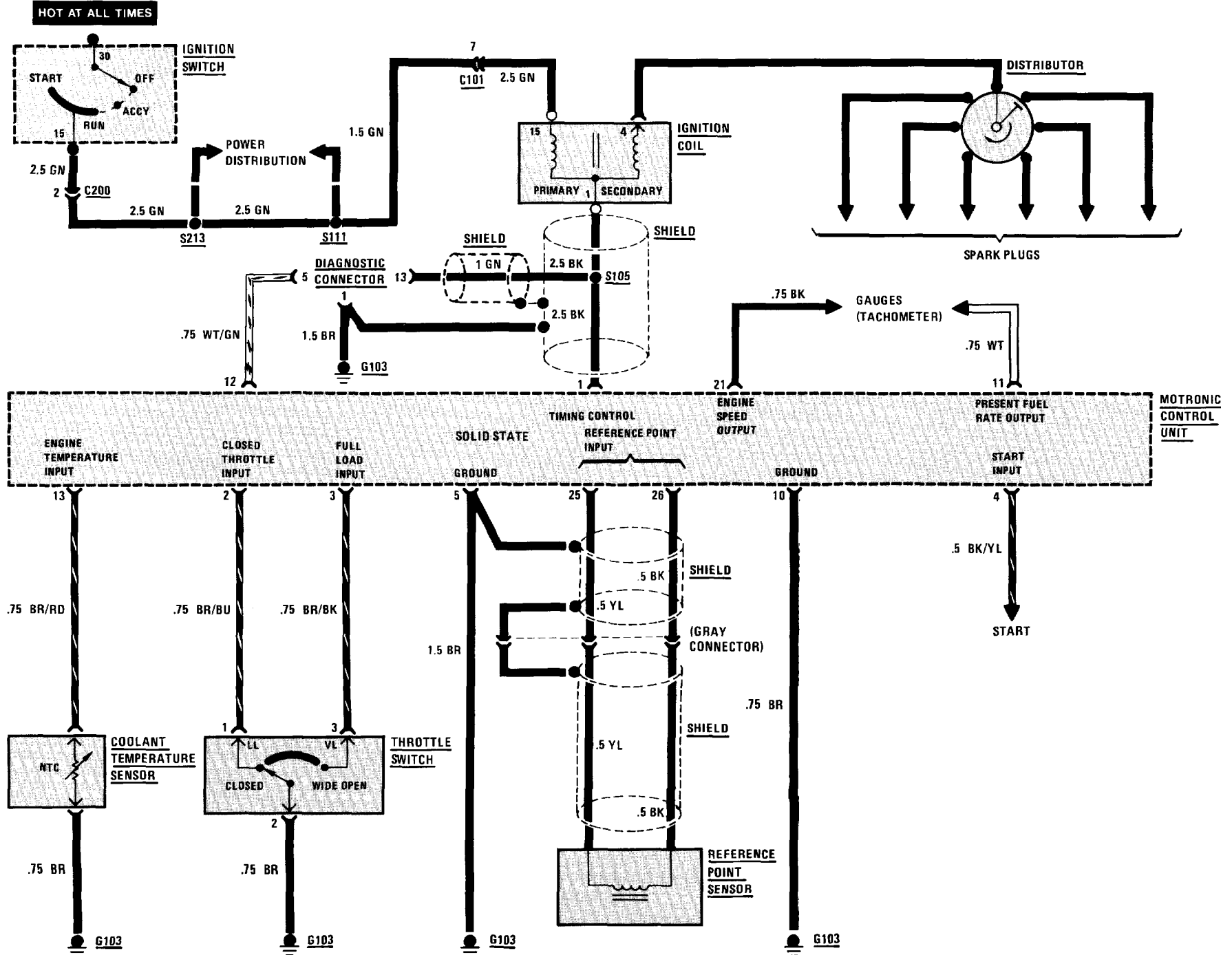

FUEL DELIVERY/FUEL CONTROL

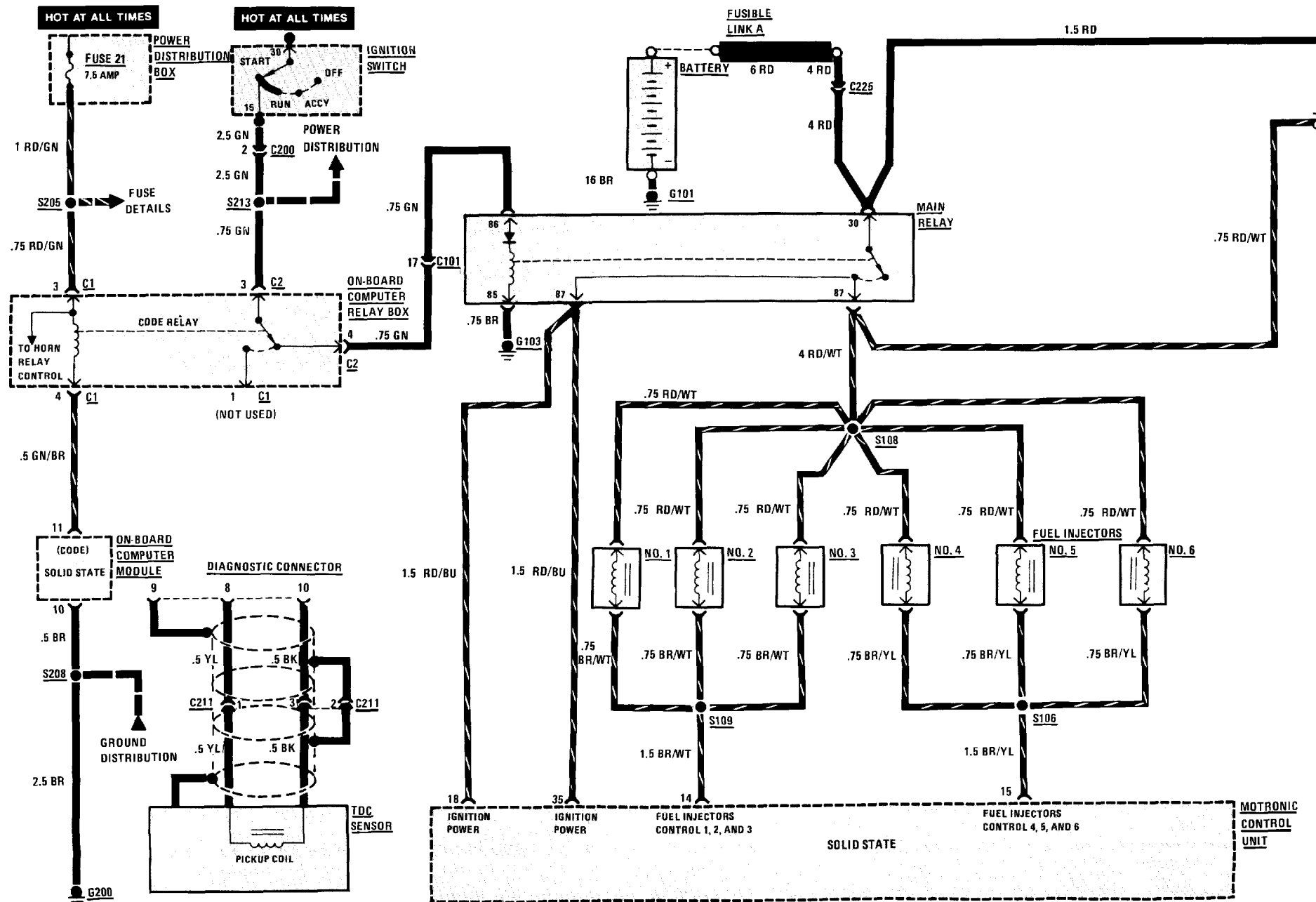

FUEL DELIVERY/FUEL CONTROL/IDLE SPEED CONTROL

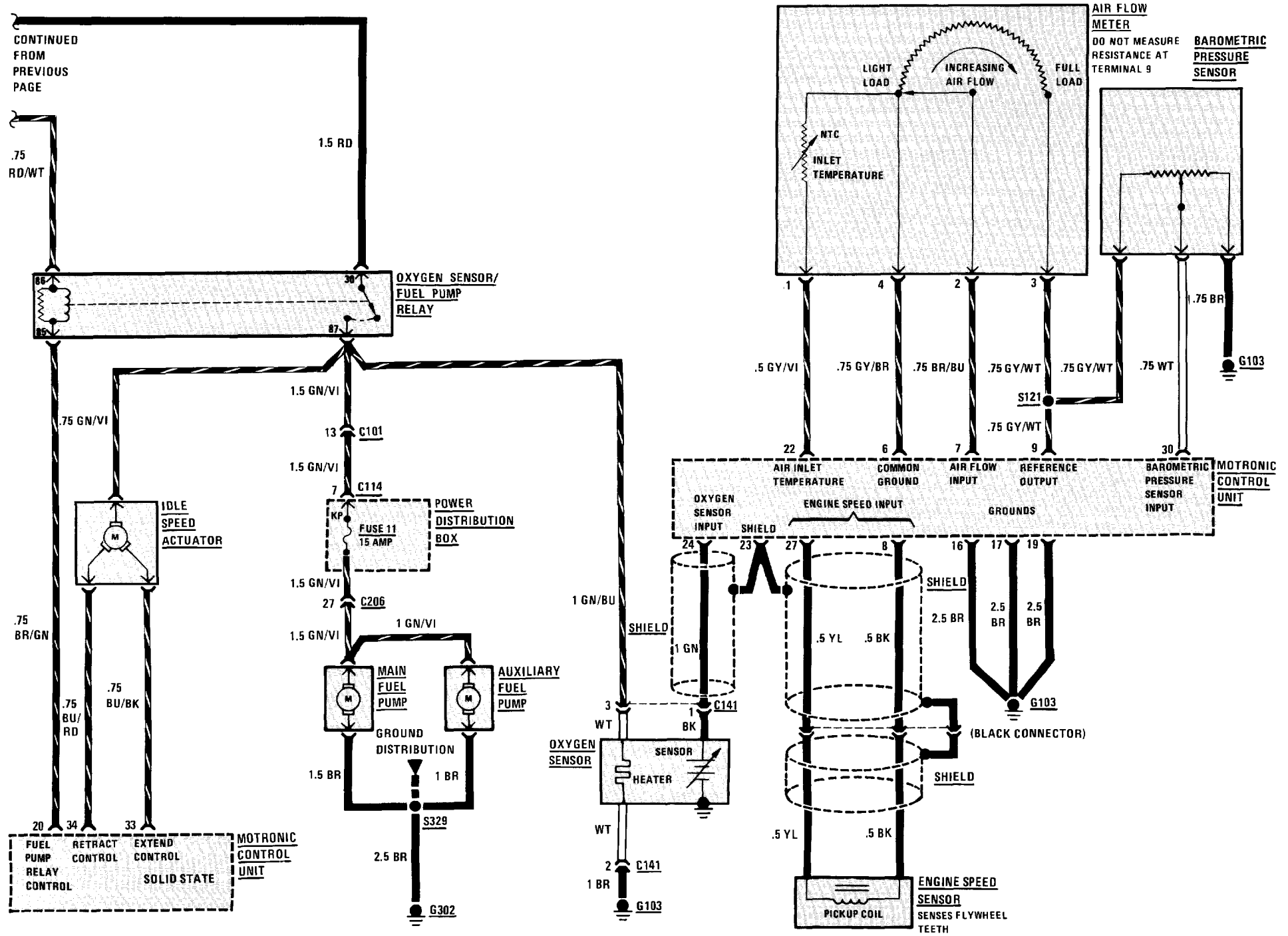

FUEL DELIVERY/EVAPORATIVE PURGE

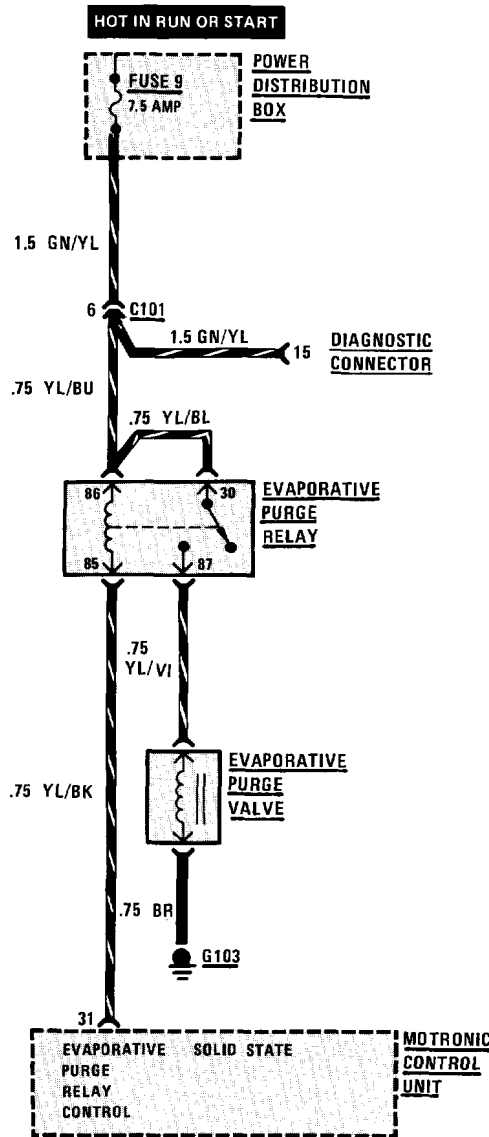

# 2460-0 ELECTRONIC TRANSMISSION CONTROL

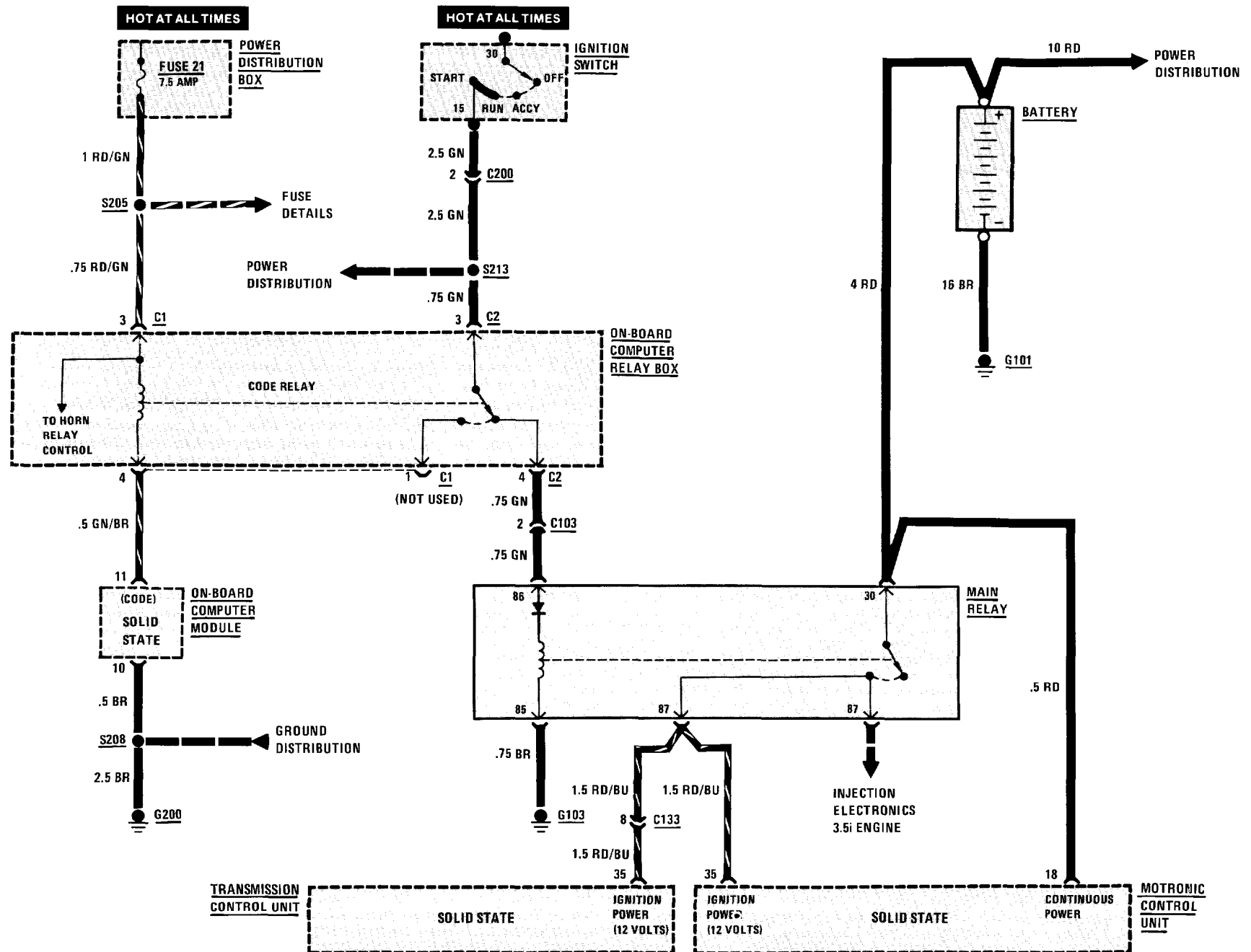

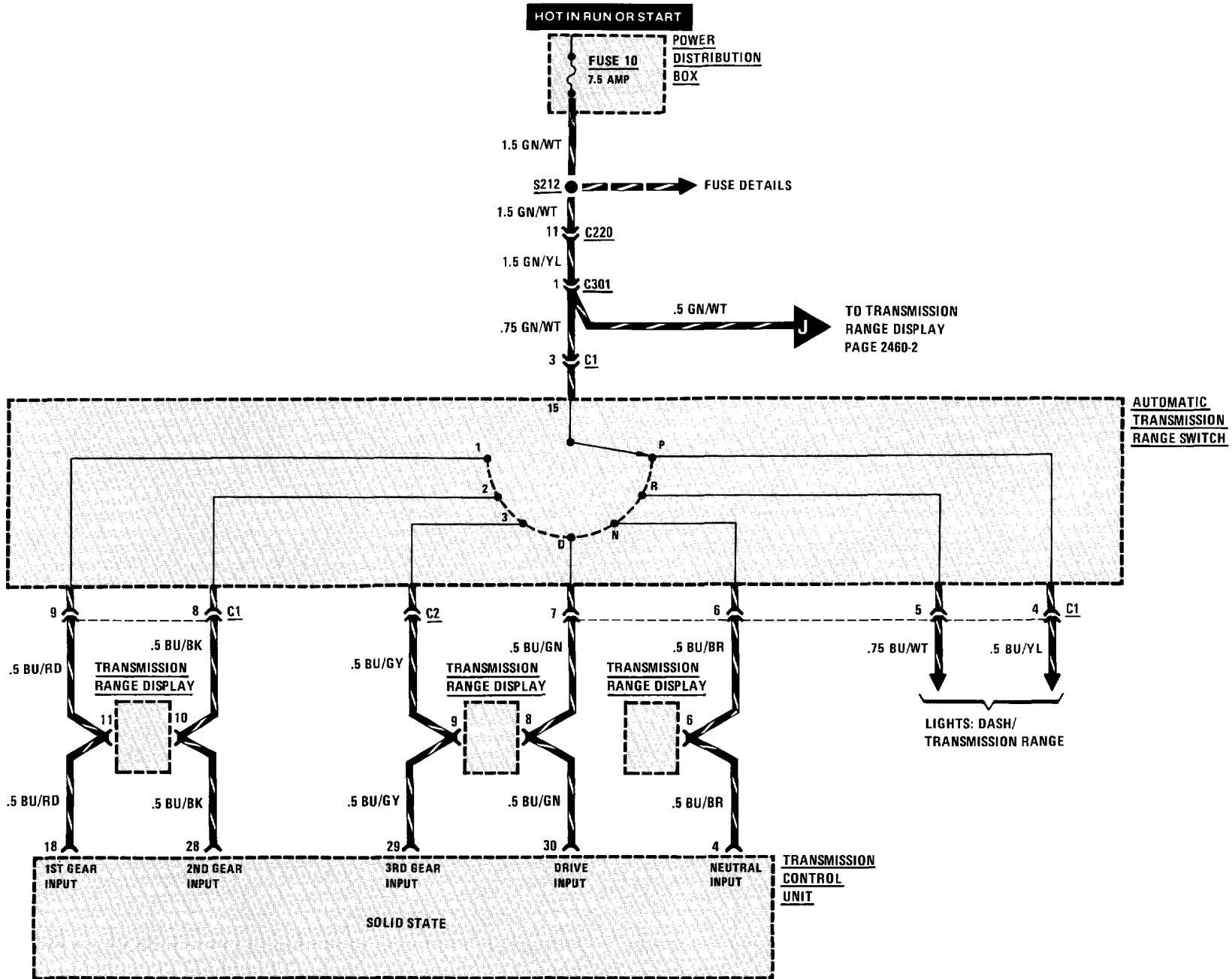

# 2460-2 ELECTRONIC TRANSMISSION CONTROL

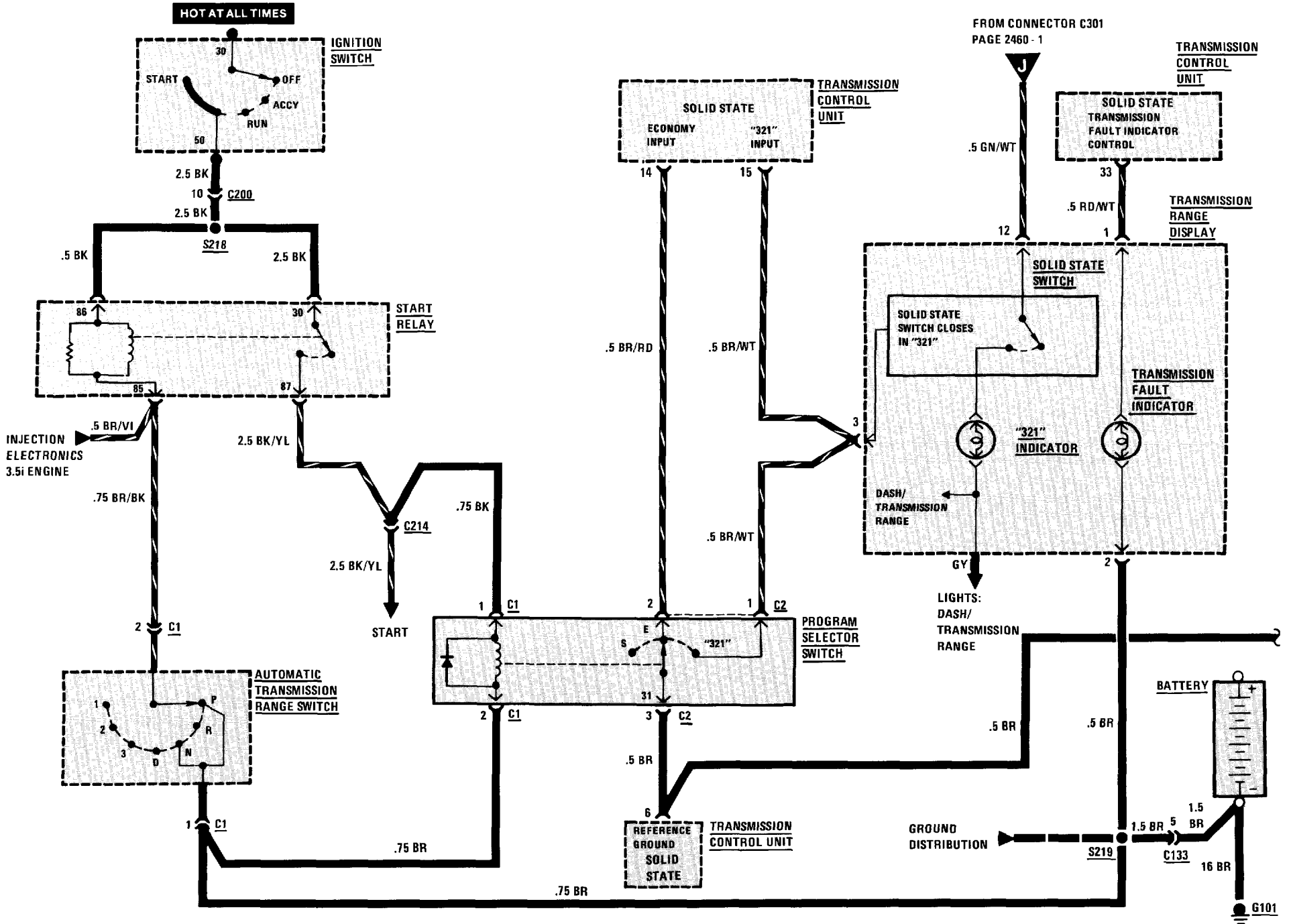



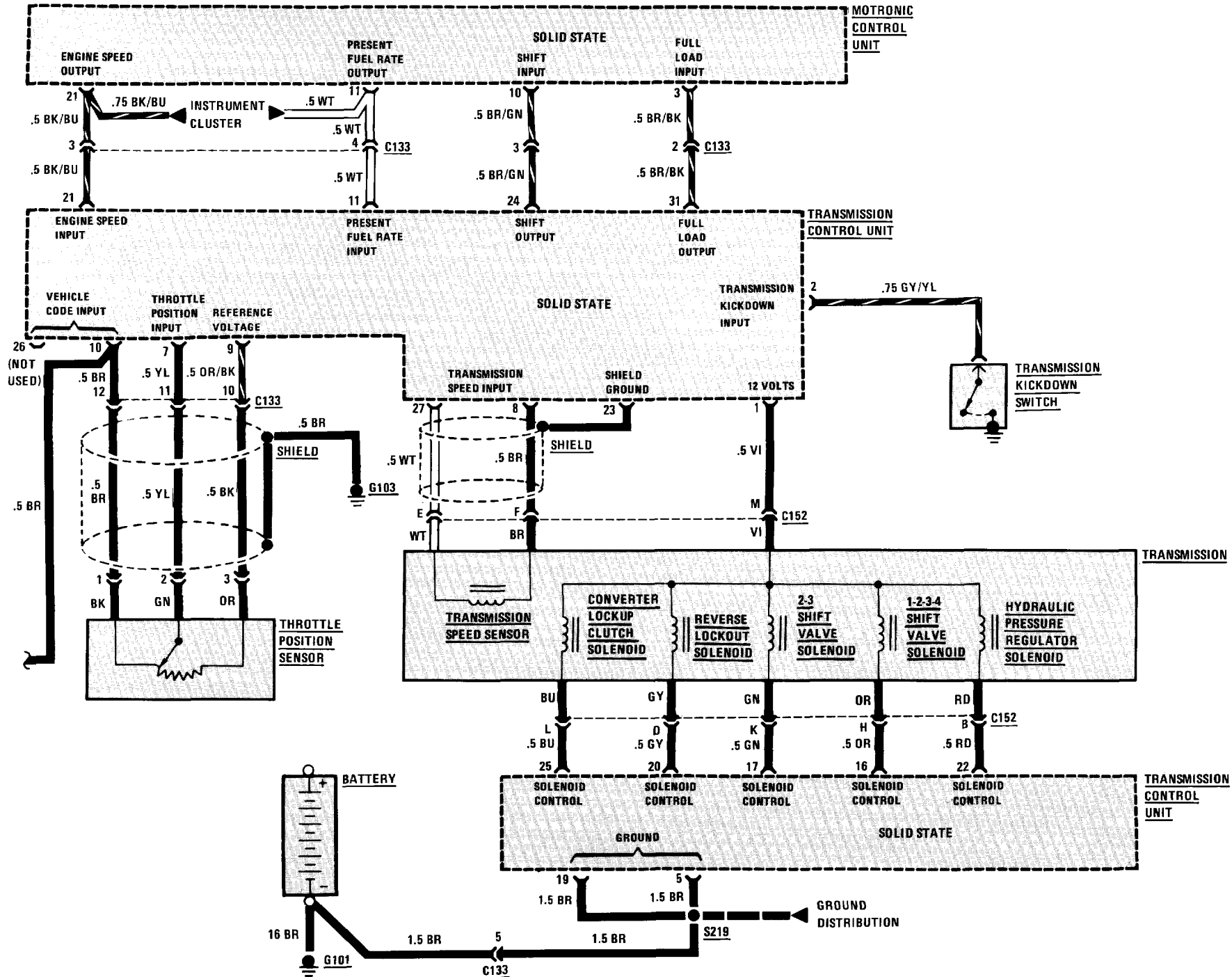

## 2460A-0 ELECTRONIC TRANSMISSION CONTROL

### TROUBLESHOOTING HINTS

- Try the following check before doing the System Check.  
Check Fuses 21 and 10 if all the Transmission Range Display bulbs do not operate.
- Go to System Check for a guide to normal operation.

### SYSTEM CHECK

- Use the System Check Table as a guide to normal operation.
- Refer to System Diagnosis for a list of symptoms and diagnostic steps.

**SYSTEM CHECK TABLE**

ACTION	NORMAL OPERATION
Turn the Ignition Switch to RUN.	The Transmission Fault Indicator flashes twice, then stays on.
Set the Program Selector Switch to 321.	The 321 Indicator lights.
Crank the engine.	The Program Selector Switch returns to E.
Start the engine.	The Transmission Fault Indicator goes out with the engine running.
Drive the car with the Program Selector Switch in 321.	The car operates in selected gear only (first, second, or third gear).
Drive the car with the Program Selector Switch in S.	First, second, and third gears are kept selected up to full engine speed. Fourth gear (overdrive) is not selected.
Drive the car with the Program Selector Switch in E.	Transmission shifts at lower engine speeds and a fourth gear (overdrive) is available.

- Refer to System Diagnosis when a result is not normal.

### SYSTEM DIAGNOSIS

- Do the tests listed for your symptom in the Symptom Table below.
- Tests follow the Symptom Table.

**SYMPTOM TABLE**

SYMPTOM	DO TEST
Transmission Fault Indicator does not flash when the Ignition Switch is turned to RUN and lights when the engine is running.	A: Transmission Control Unit 5 Volt Power and Ground Test.
Transmission Fault Indicator flashes when the Ignition Switch is turned to RUN and lights with the engine running.	C: Engine Speed and Fuel Rate Input Test. D: Hydraulic Pressure Regulator and Solenoid Test.
Transmission Fault Indicator does not light with the Ignition Switch in RUN and the engine not running.	B: Transmission Control Unit Ignition Power Test. G: Transmission Fault Indicator Test.
Program Selector Switch does not return to E when the engine is cranked.	F: Program Selector Switch Return Test.
321 Indicator does not light when the Program Selector Switch is set to 321, but Transmission operates in the 321 mode.	H: 321 Indicator Test.

(Continued on next page)

(Continued from previous page)

Transmission does not operate in selected program and the Transmission Fault Indicator is off with the engine running.	I: Program Selector Switch Continuity Test.
Kickdown function is inoperative.	K: Kickdown Switch Test.
Shift Points are inaccurate or rough and the Transmission Fault Indicator is off with the engine running.	L: Gear Input Test. M: Throttle Position Sensor and Wide Open Throttle Output Test. J: Transmission Speed Sensor Test.

**B: TRANSMISSION CONTROL UNIT IGNITION POWER TEST**

<b>Measure: VOLTAGE</b>		
<b>At: TRANSMISSION CONTROL UNIT CONNECTOR (Connected)</b>		
<b>Condition:</b> • Ignition Switch: RUN		
Measure Between	Correct Voltage	For Diagnosis
35 & Ground	Battery	See 1
<ul style="list-style-type: none"> <li>If the result is correct, go to the Symptom Table.</li> </ul> <ol style="list-style-type: none"> <li>Check/repair the wire from terminal 35 to the Main Relay for an open (see schematic).</li> </ol>		

- Go to Test E: Motronic Control Unit Test, if the Tachometer does not operate.
- Check/repair the wire to terminal 21 if the Tachometer operates.

**A: TRANSMISSION CONTROL UNIT 5 VOLT POWER AND GROUND TEST**

<b>Measure: VOLTAGE</b>		
<b>At: TRANSMISSION CONTROL UNIT CONNECTOR (Connected)</b>		
<b>Condition:</b> • Ignition Switch: RUN		
Measure Between	Correct Voltage	For Diagnosis
24 & Ground	Approximately 5 Volts	See 1
24 & 19	Approximately 5 Volts	See 2
24 & 5	Approximately 5 Volts	See 2
<ul style="list-style-type: none"> <li>If all the results are correct, replace the Transmission Control Unit.</li> </ul> <ol style="list-style-type: none"> <li>Go to Test E: Motronic Control Unit Test.</li> <li>Check/repair the ground wire for an open (see schematic).</li> </ol>		

**C: ENGINE SPEED AND FUEL RATE INPUT TEST**

<b>Measure: VOLTAGE</b>		
<b>At: TRANSMISSION CONTROL UNIT CONNECTOR (Connected)</b>		
<b>Condition:</b> • Ignition Switch: RUN		
Measure Between	Correct Voltage	For Diagnosis
11 & Ground	Greater than 10 Volts	See 1
21 & Ground	Greater than 10 Volts	See 2
<ul style="list-style-type: none"> <li>If all the results are correct, go to the Symptom Table.</li> </ul> <ol style="list-style-type: none"> <li>Go to Test E: Motronic Control Unit Test, if the Fuel Rate Gauge does not operate.</li> </ol> <ul style="list-style-type: none"> <li>Check/repair the wire to terminal 11 if the Fuel Rate Gauge operates.</li> </ul>		

**D: HYDRAULIC PRESSURE REGULATOR AND SOLENOID TEST**

<b>Measure: RESISTANCE</b>		
<b>At: TRANSMISSION CONTROL UNIT CONNECTOR (Disconnected)</b>		
Measure Between	Correct Resistance	For Diagnosis
1 & Ground	Greater than 500 K Ohms	See 1
1 & 25	25 to 46 Ohms	See 2
1 & 20	25 to 46 Ohms	See 2
1 & 17	25 to 46 Ohms	See 2
1 & 16	25 to 46 Ohms	See 2
1 & 22	1.8 to 4.6 Ohms	See 3
<ul style="list-style-type: none"> <li>If all the results are correct, replace the Transmission Control Unit.</li> </ul> <ol style="list-style-type: none"> <li>Check the wiring from terminals 1, 16, 17, 20, 22, and 25 for shorts to ground (see schematic). Check the Pressure Regulator and Solenoids for a short to ground if wiring is OK. Repair/replace as necessary.</li> <li>Check/repair wire (see schematic) and connector terminal. Replace the Solenoid Valve (see schematic) if wire and connector terminal are OK.</li> <li>Check/repair wire (see schematic) and connector terminal. Replace the Hydraulic Pressure Regulator Solenoid if wire and connector terminal are OK.</li> </ol>		

(Continued in next column)

## 2460A-2 ELECTRONIC TRANSMISSION CONTROL

### E: MOTRONIC CONTROL UNIT TEST

<b>Measure: VOLTAGE</b> <b>At: MOTRONIC CONTROL UNIT CONNECTOR (Connected)</b> <b>Condition:</b> <ul style="list-style-type: none"> <li>• Ignition Switch: RUN</li> </ul>		
Measure Between	Correct Voltage	For Diagnosis
10 & Ground	Approximately 5 Volts	See 1
11 & Ground	Greater than 10 Volts	See 1
21 & Ground	Greater than 10 Volts	See 1
3 & Ground	Approximately 5 Volts	See 1
<ul style="list-style-type: none"> <li>• If all the results are correct, check/repair the wire(s) to the Transmission Control Unit for an open(s).</li> </ul> <ol style="list-style-type: none"> <li>1. Check the wire to the Transmission Control Unit for a short to ground (see schematic). Check/replace the Motronic Control Unit if wire is OK.</li> </ol>		

### F: PROGRAM SELECTOR SWITCH RETURN TEST

<b>Measure: VOLTAGE</b> <b>At: PROGRAM SELECTOR SWITCH CONNECTOR C1 (Connected)</b> <b>Condition:</b> <ul style="list-style-type: none"> <li>• Ignition Switch: START</li> </ul>		
Measure Between	Correct Voltage	For Diagnosis
1 & Ground	Greater than 8 Volts	See 1
1 & 2	Greater than 8 Volts	See 2
<ul style="list-style-type: none"> <li>• If all the results are correct, replace the Program Selector Switch.</li> </ul> <ol style="list-style-type: none"> <li>1. Check/repair the wire to terminal 1 for an open (see schematic).</li> <li>2. Check/repair the wire from terminal 2 for an open (see schematic).</li> </ol>		

### G: TRANSMISSION FAULT INDICATOR TEST (TABLE 1)

<b>Measure: VOLTAGE</b> <b>At: TRANSMISSION CONTROL UNIT CONNECTOR (Connected)</b> <b>Condition:</b> <ul style="list-style-type: none"> <li>• Ignition Switch: RUN</li> </ul>		
Measure Between	Correct Voltage	For Diagnosis
33 & Ground	Greater than 10 Volts	See 1
<ul style="list-style-type: none"> <li>• If the voltage is correct, go to Table 2.</li> </ul> <ol style="list-style-type: none"> <li>1. Replace the Transmission Control Unit.</li> </ol>		

### G: TRANSMISSION FAULT INDICATOR TEST (TABLE 2)

<b>Measure: VOLTAGE</b> <b>At: TRANSMISSION RANGE DISPLAY CONNECTOR (Disconnected)</b> <b>Condition:</b> <ul style="list-style-type: none"> <li>• Ignition Switch: RUN</li> </ul>		
Measure Between	Correct Voltage	For Diagnosis
1 & Ground	Greater than 10 Volts	See 1
1 & 2	Greater than 10 Volts	See 2
<ul style="list-style-type: none"> <li>• If all the voltages are correct, check the bulb and printed circuit board. Replace as necessary.</li> </ul> <ol style="list-style-type: none"> <li>1. Check/repair the wire to terminal 1 for an open (see schematic).</li> <li>2. Check/repair the wire from terminal 2 for an open (see schematic).</li> </ol>		

### H: 321 INDICATOR TEST

<b>Measure: VOLTAGE</b> <b>At: TRANSMISSION RANGE DISPLAY CONNECTOR (Disconnected)</b> <b>Conditions:</b> <ul style="list-style-type: none"> <li>• Ignition Switch: RUN</li> <li>• Program Selector Switch: 321</li> </ul>		
Measure Between	Correct Voltage	For Diagnosis
3 & Ground	0 Volts	See 1
12 & Ground	Greater than 10 Volts	See 2

(Continued from previous page)

- If all the results are correct, check the GY wire bulb, printed circuit board, and connector terminals. Repair/replace as necessary.
1. Check/repair the wire to terminal 3 and the connector terminal (see schematic).
  2. Check/repair the wire to terminal 12 for an open (see schematic).

**I: PROGRAM SELECTOR SWITCH CONTINUITY TEST**

<b>Measure: RESISTANCE</b>		
<b>At: TRANSMISSION CONTROL UNIT CONNECTOR (Disconnected)</b>		
<b>Conditions:</b>		
<ul style="list-style-type: none"> <li>• Transmission Range Display Connector: DISCONNECTED</li> <li>• Program Selector Switch: E</li> </ul>		
Measure Between	Correct Resistance	For Diagnosis
14 & 6	Approximately 0 Ohms	See 1
• Set Program Selector Switch to 321.		
15 & 6	Approximately 0 Ohms	See 1
• Set Program Selector Switch to S.		
14 & 6	Infinite Ohms	See 2
15 & 6	Infinite Ohms	See 2
<ul style="list-style-type: none"> <li>• If all the results are correct, replace the Transmission Control Unit.</li> </ul> <ol style="list-style-type: none"> <li>1. Check the wires and connector terminal (see schematic). Replace the Program Selector Switch if wires are OK.</li> <li>2. Replace the Program Selector Switch.</li> </ol>		

**J: TRANSMISSION SPEED SENSOR TEST (TABLE 1)**

<b>Measure: RESISTANCE</b>		
<b>At: TRANSMISSION CONTROL UNIT CONNECTOR (Disconnected)</b>		
Measure Between	Correct Resistance	For Diagnosis
8 & Ground	Greater than 500 K Ohms	See 1
8 & 27	800 Ohms to 1.6 K Ohms	See 2
<ul style="list-style-type: none"> <li>• If all the results are correct, go to Table 2.</li> </ul> <ol style="list-style-type: none"> <li>1. Check/repair the wires from terminals 8 and 27 for shorts to ground (see schematic). Replace the Transmission Speed Sensor if wires are OK.</li> <li>2. Check/repair the wires from terminals 8 and 27 for opens (see schematic). Replace the Transmission Speed Sensor if wires are OK.</li> </ol>		

**J: TRANSMISSION SPEED SENSOR TEST (TABLE 2)**

<b>Measure: AC VOLTAGE</b>		
<b>At: TRANSMISSION CONTROL UNIT CONNECTOR (Disconnected)</b>		
<b>Conditions:</b>		
<ul style="list-style-type: none"> <li>• Lift car (rear wheels must turn freely)</li> <li>• Engine running</li> <li>• Gear Selector: D</li> <li>• Speedometer: 30 km/h (20 mph)</li> </ul>		
Measure Between	Correct Voltage	For Diagnosis
8 & 27	Greater than 3.5 Volts AC	See 1
<ul style="list-style-type: none"> <li>• If the result is correct, replace the Transmission Control Unit.</li> </ul> <ol style="list-style-type: none"> <li>1. Replace the Transmission Speed Sensor.</li> </ol>		

**K: KICKDOWN SWITCH TEST**

<b>Measure: VOLTAGE</b>		
<b>At: TRANSMISSION CONTROL UNIT CONNECTOR (Connected)</b>		
<b>Condition:</b>		
• Ignition Switch: RUN		
Measure Between	Correct Voltage	For Diagnosis
2 & Ground	Approximately 5 Volts	See 1
• Depress accelerator pedal to Kickdown.		
2 & Ground	0 Volts	See 2
<ul style="list-style-type: none"> <li>• If all the results are correct, check the BMW Troubleshooting Manual to verify the problem is not in the Transmission. Replace the Transmission Control Unit if the problem is not in the Transmission.</li> </ul> <ol style="list-style-type: none"> <li>1. Check the wire from terminal 2 and Kickdown Switch for a short to ground (see schematic). Replace the Transmission Control Unit if wire and Kickdown Switch are OK.</li> <li>2. Check the wire from terminal 2 for an open (see schematic). Replace the Kickdown Switch if wire is OK.</li> </ol>		

(Continued on next page)

## 2460A-4 ELECTRONIC TRANSMISSION CONTROL

### L: GEAR INPUT TEST

Measure: VOLTAGE At: TRANSMISSION CONTROL UNIT CONNECTOR (Connected) Conditions: • Ignition Switch: RUN • Gear Selector: N (Neutral)		
Measure Between	Correct Voltage	For Diagnosis
4 & Ground	Battery	See 1
• Put the Gear Selector in all positions except N (Neutral).		
4 & Ground	Less than 1 Volt	See 2
• Put the Gear Selector in D (Drive).		
30 & Ground	Battery	See 1
• Put the Gear Selector in all positions except D (Drive).		
30 & Ground	Less than 1 Volt	See 2
• Put the Gear Selector in 3 (third gear).		
29 & Ground	Battery	See 1
• Put the Gear Selector in all positions except 3 (third gear).		
29 & Ground	Less than 1 Volt	See 2
• Put the Gear Selector in 2 (second gear).		
28 & Ground	Battery	See 1
• Put the Gear Selector in all positions except 2 (second gear).		
28 & Ground	Less than 1 Volt	See 2
• Put the Gear Selector in 1 (first gear).		
18 & Ground	Battery	See 1

(Continued in next column)

(Continued from previous column)

• Put the Gear Selector in all positions except 1 (first gear).		
18 & Ground	Less than 1 Volt	See 2
• If all the results are correct, go to the Symptom Table.		
1. If the associated bulb in the Transmission Range Display lights, check/repair the wire to the Transmission Range Display for an open (see schematic).		
• If the associated bulb in the Transmission Range Display does not light, check/repair wire from the Automatic Transmission Range Switch, and the Automatic Transmission Range Switch (see schematic).		
2. Check/repair the wire for a short to voltage and the Automatic Transmission Range Switch (see schematic).		

### M: THROTTLE POSITION SENSOR AND WIDE OPEN THROTTLE OUTPUT TEST

Measure: VOLTAGE At: TRANSMISSION CONTROL UNIT CONNECTOR (Connected) Condition: • Ignition Switch: RUN		
Measure Between	Correct Voltage	For Diagnosis
31 & Ground	Approximately 5 Volts	See 1
9 & Ground	Approximately 5 Volts	See 2
9 & 6	Approximately 5 Volts	See 2
• Operate Throttle through its full range.		

(Continued in next column)

(Continued from previous column)

7 & 6	.7 Volts (Throttle closed) increasing evenly to 4.77 Volts (Throttle fully opened)	See 3
• Depress throttle pedal to the floor.		
31 & Ground	Approximately .3 Volts	See 2
• If all the results are correct, go to the Symptom Table.		
1. Go to Test E: Motronic Control Unit Test.		
2. Replace the Transmission Control Unit.		
3. Check/repair the wiring to the Throttle Position Sensor. Adjust the Throttle Position Sensor if wiring is OK. Replace the Throttle Position Sensor if adjustment does not correct the problem.		

**NOTE:** The highest voltage at full open position should be .22 volts less than the stabilized voltage. Adjust Throttle Position Sensor accordingly.

## CIRCUIT OPERATION

By operating the Program Selector Switch, the driver can select 3 different transmission modes. When the Program Selector Switch is set to E (Economy), the Economy Input (terminal 14) in the Transmission Control Unit is grounded through terminal 6. The Economy Mode is designed for smooth, refined shift points and low fuel consumption. A fourth gear, or overdrive ratio, is available in the Economy Mode to reduce engine speed and noise level. When the Program Selector Switch is set to 321, the 321 Input (terminal 15) in the Transmission Control Unit is grounded through terminal 6 and the 321 Indicator lights. The Transmission does not shift up or down and will operate in the selected gear only. When the Program Selector Switch is set to S, voltage is present at the Economy and 321 Inputs in the Transmission Control Unit. Fourth gear is not selected and first, second, and third gears are kept selected up to full engine speed. The Program Selector Switch is designed to return to E when the engine is cranked. When the engine is cranked, voltage is applied to the coil in the Program Selector Switch through the Ignition Switch and the Start Relay. The coil energizes and the Program Selector returns to E.

The Transmission Control Unit monitors engine speed (terminal 21), fuel rate (terminal 11), Throttle position (terminal 7), road speed (terminals 8 and 27), Kickdown signal (terminal 2), Gear Selector position (terminals 4, 30, 29, 28 and 18) and Program Selector Switch position (terminals 14 and 15). The Transmission Control Unit's electronic processing circuit compares this information with the program data to establish the correct gear and smooth shift points by controlling the Shift Valve Solenoids and the Hydraulic Pressure Regulator.

The Transmission Fault Indicator will light with the engine running if a problem with the control system occurs. When a fault is detected, the vehicle can only be driven in third and reverse gears. Neutral and Park also retain their functions. Voltage to the transmission (terminal 1) is not present when a fault is detected.

The Reverse Lock Solenoid prevents the driver from selecting reverse above 5 mph.

# 3435-0 BRAKE LINING WARNING

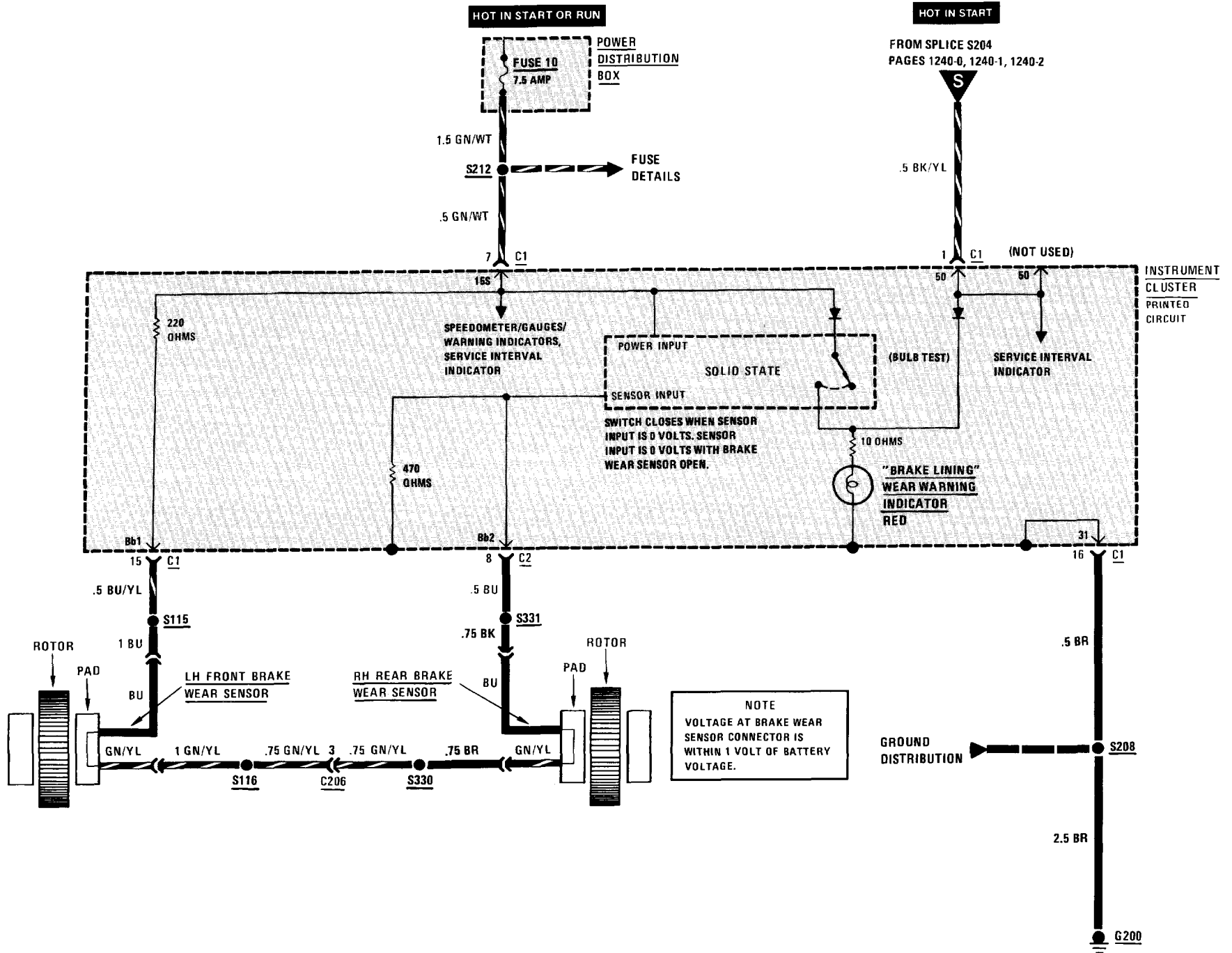



# 3450-0 ANTILOCK BRAKING SYSTEM (ABS)

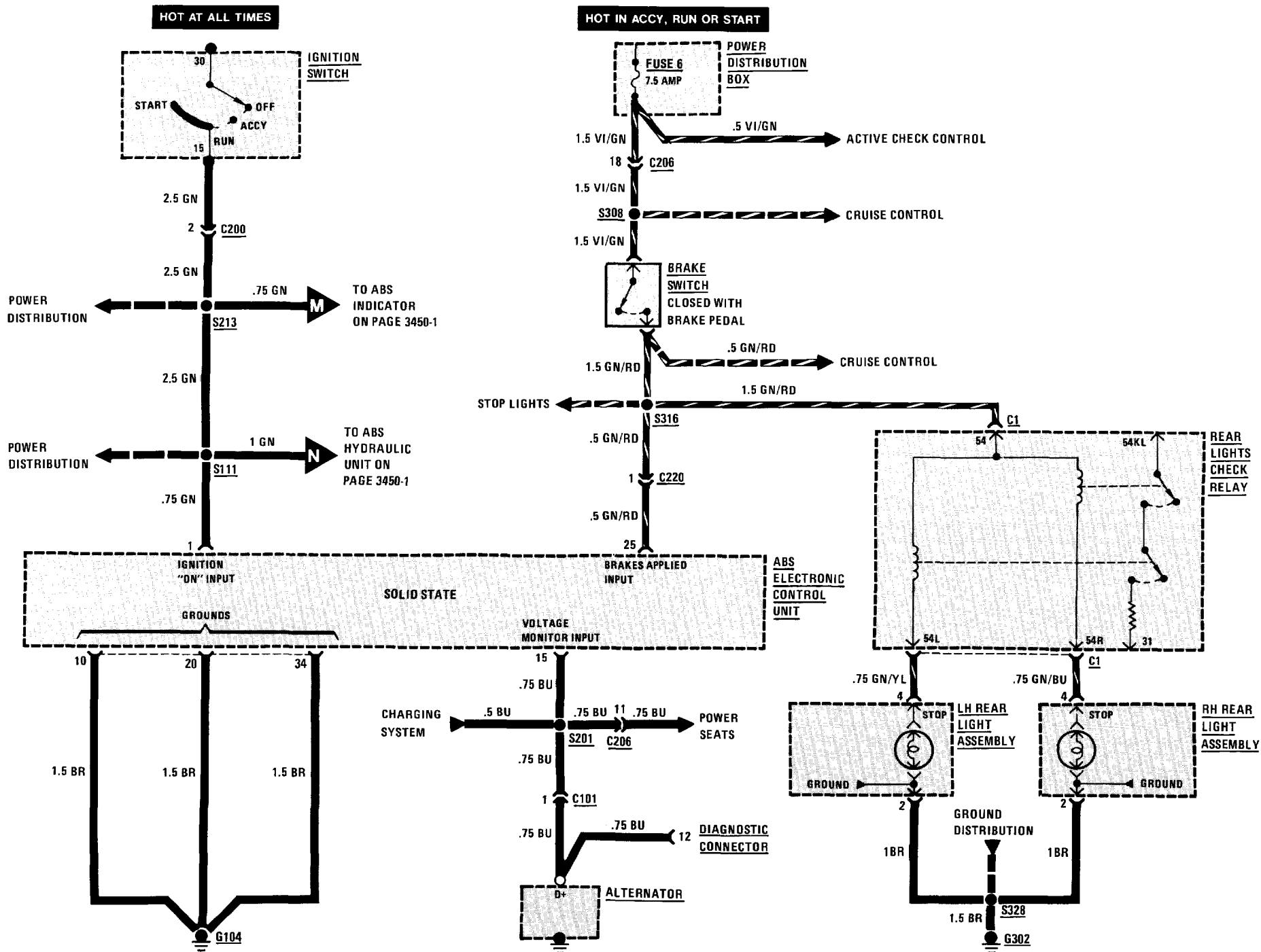

# ANTILOCK BRAKE SYSTEM (ABS) 3450-1

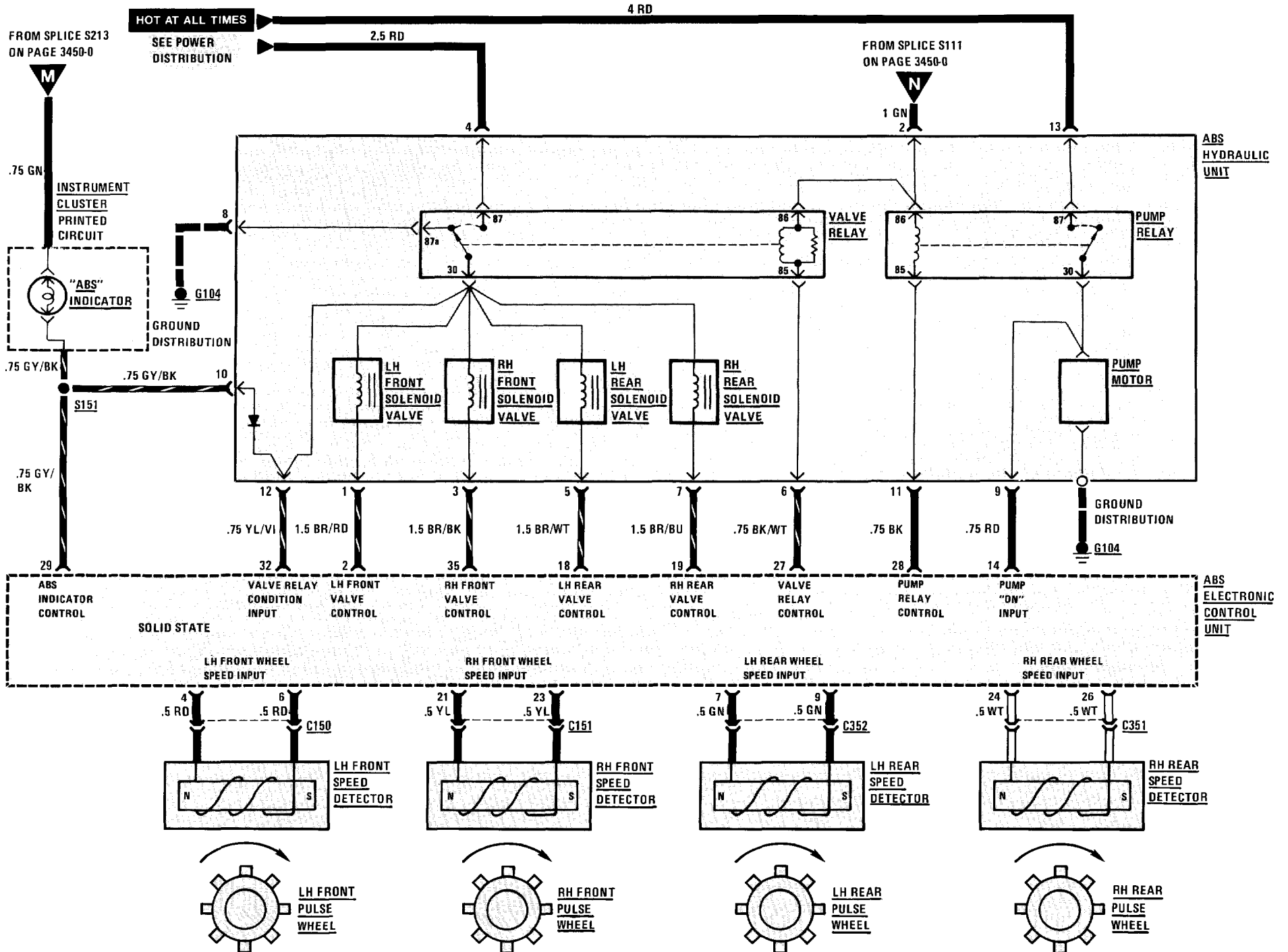

# 3700-0 SELF-LEVELING SUSPENSION

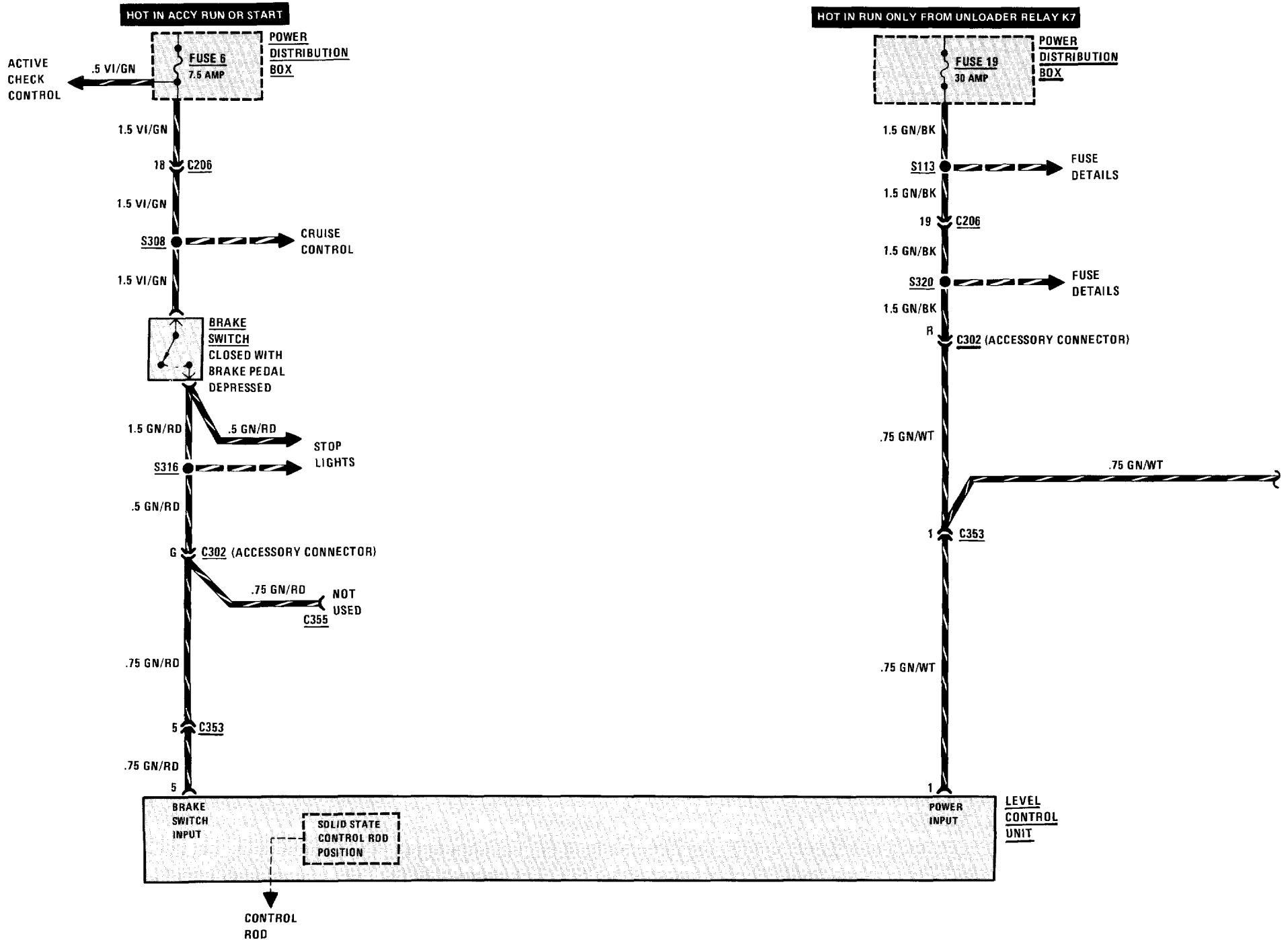

# SELF-LEVELING SUSPENSION 3700-1

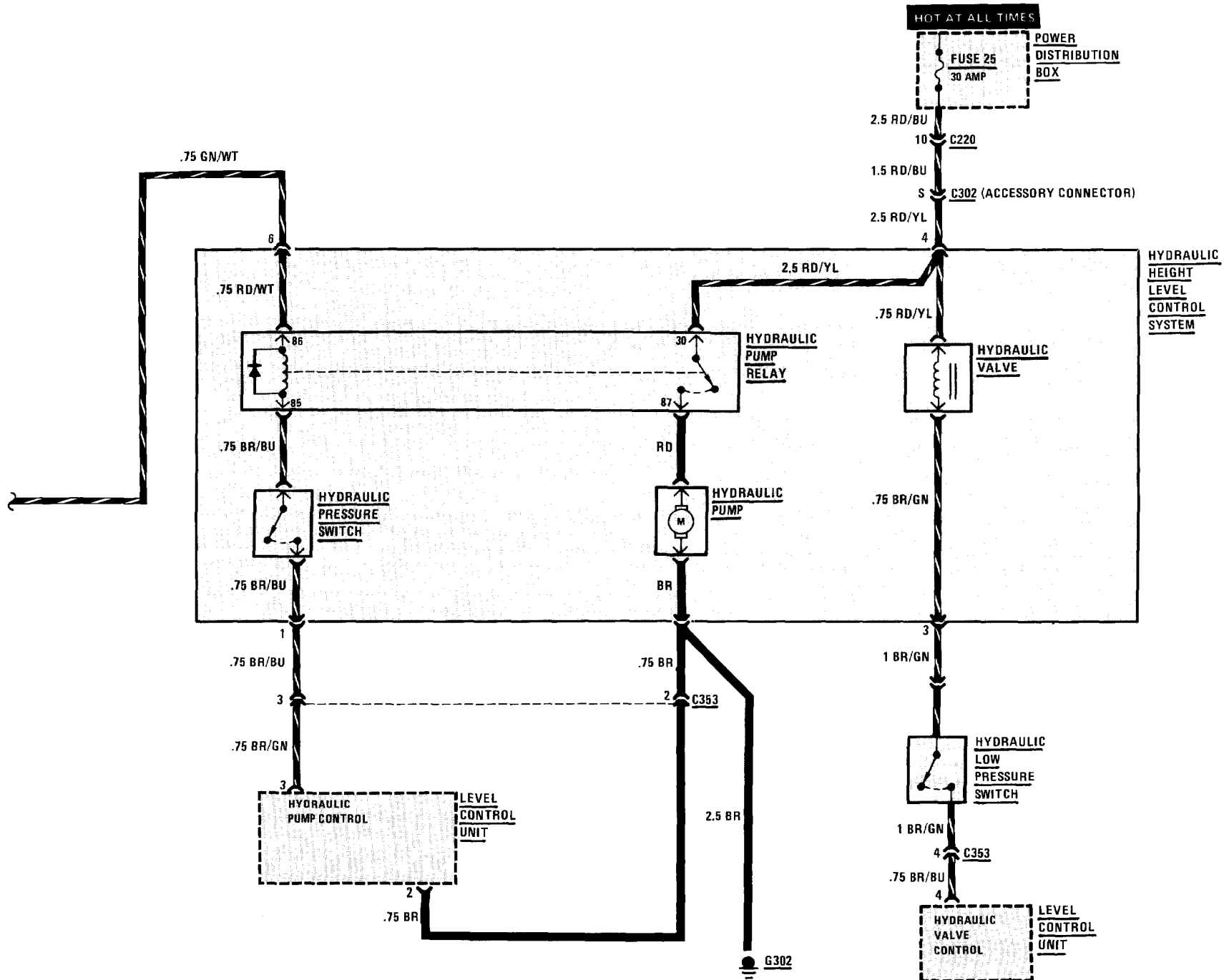

# 5116-0 POWER MIRRORS

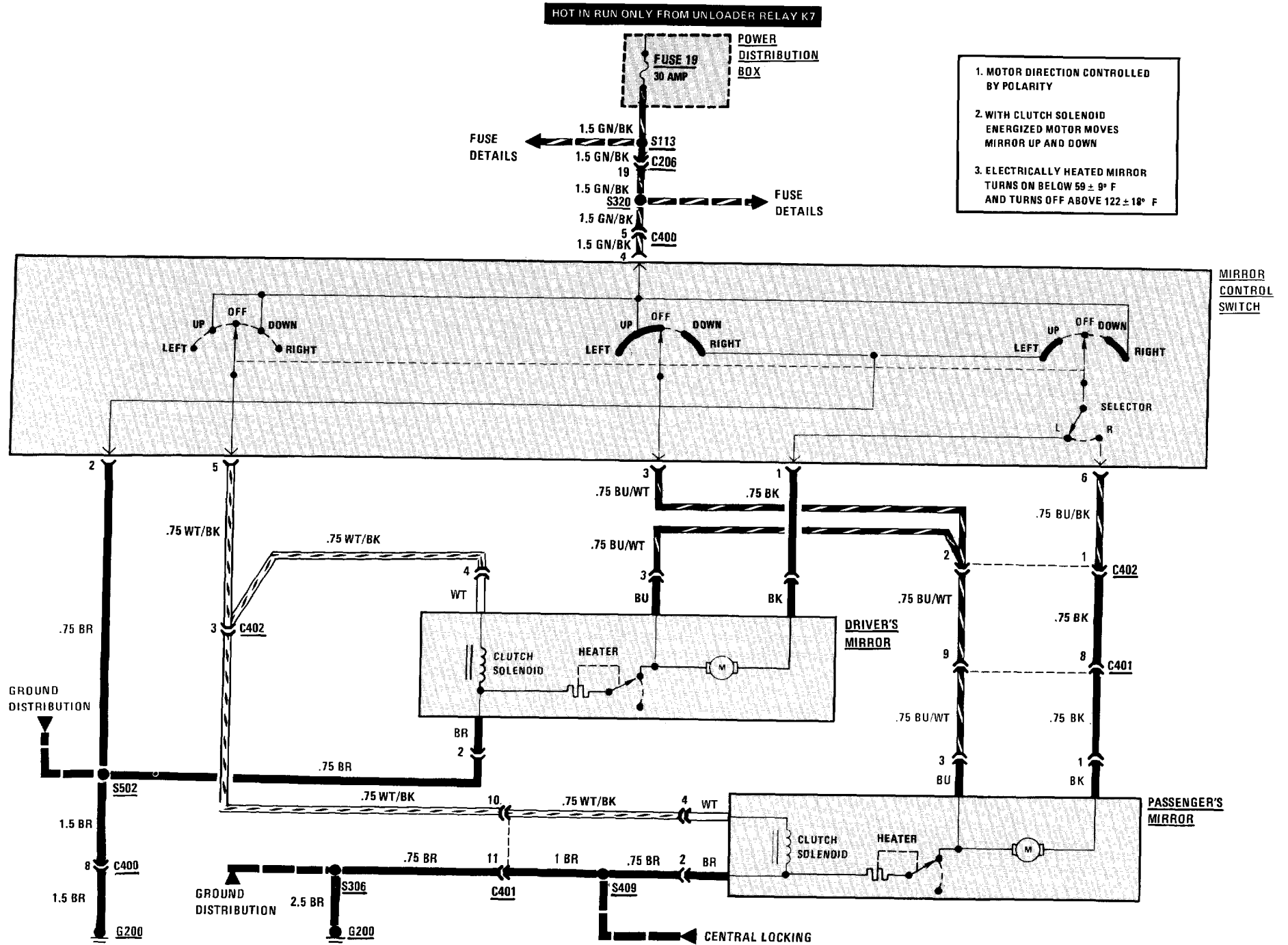

# 5126-0 CENTRAL LOCKING

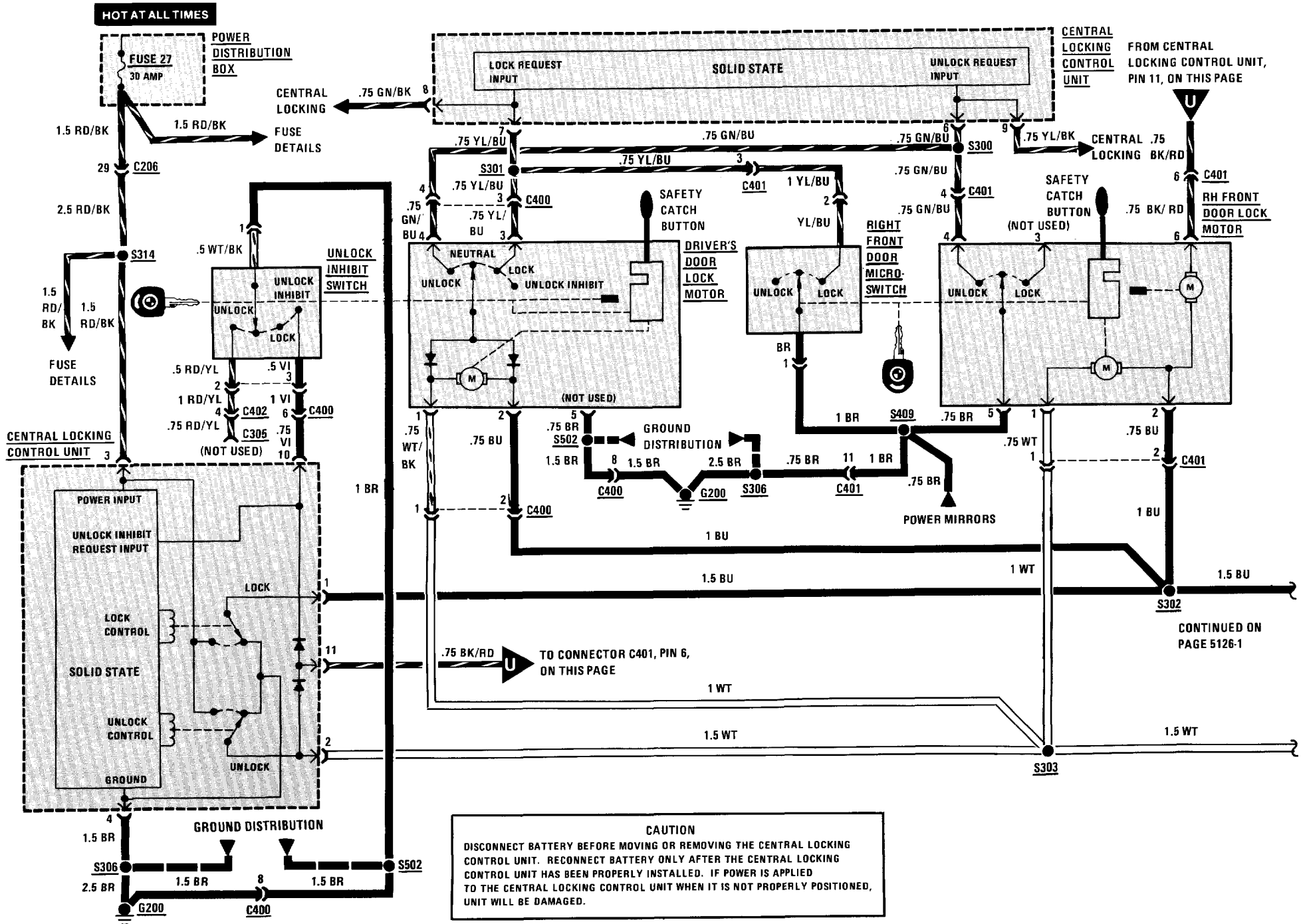

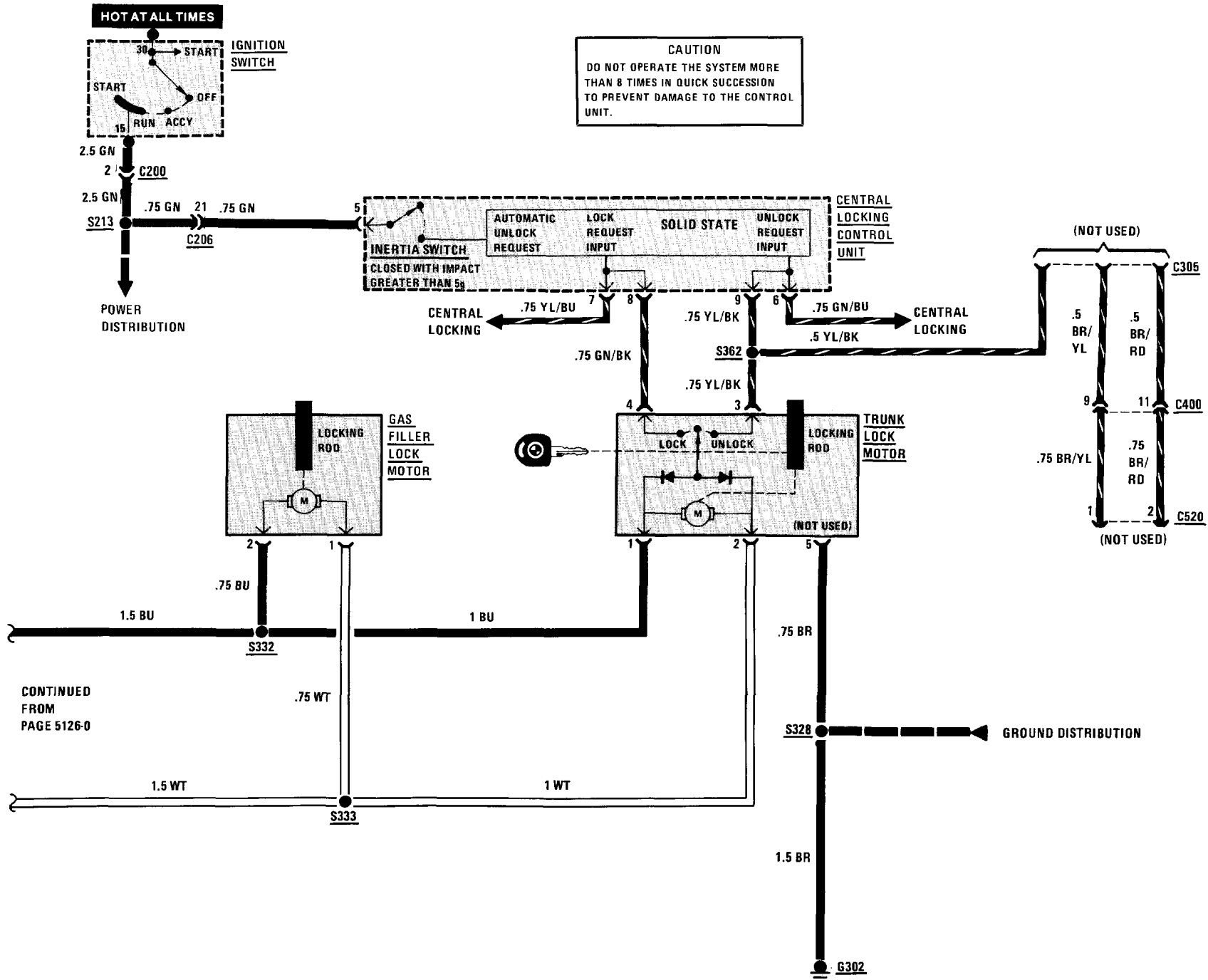

## 5126A-0 CENTRAL LOCKING

### TROUBLESHOOTING HINTS

1. Check Fuse by operating the Interior Light Timer for either Dome Light.

### SYSTEM CHECK

- Operate controls in sequence listed in the System Check Table.
- Refer to Repair Action for the Response received (tests follow the System Check Table).
- After any repair, repeat System Check to verify proper system operation.

**NOTE:** Before replacing any system component, check all connectors, splices, and wiring to that component.

**SYSTEM CHECK TABLE**

OPERATION	RESPONSE	REPAIR ACTION
1. Insert the key in the Driver's door and turn to LOCK	All doors lock	None, proceed to Operation 2
	Some doors lock	Repair/replace the suspect Door Lock Motor circuit
	No doors lock	Proceed to Operation 4
2. Turn the key to UNLOCK INHIBIT (clockwise until key is horizontal)	All doors double lock (Safety Catch Buttons cannot be pulled up by hand)	None, proceed to Operation 3
	Driver's door double locks and only some of the other doors double lock	Repair/replace the suspect Door Lock Motor
	Driver's door double locks but all the other doors do not double lock	Perform Test B
	Driver's door does not double lock	Mechanical problem, see BMW Troubleshooting Manual



**SYSTEM CHECK TABLE (CONT'D)**

OPERATION	RESPONSE	REPAIR ACTION
3. Turn the key to UNLOCK	All doors unlock	None, proceed to Operation 4
	Some doors unlock	Repair/replace the suspect Door Lock Motor circuit
	No doors unlock	Proceed to Operation 5
4. Insert the key in the Passenger's door and turn to LOCK	All doors lock	If the doors did not lock in Operation 1, repair/replace the Driver's Door Lock Switch, otherwise proceed to Operation 5
	Some doors lock	Repair/replace the suspect Door Lock Motor circuit
	No doors lock	If all the doors locked in Operation 1, repair/replace the Right Front Door Microswitch. If the doors did not lock in Operation 1, perform Test A
5. Insert the key in the Passenger's door and turn to UNLOCK	All doors unlock	If all the doors did not unlock in Operation 3, repair/replace the Driver's Door Lock Switch, otherwise proceed to Operation 6
	Some doors unlock	Repair/replace the suspect Door Lock Motor
	No doors unlock	If all the doors unlocked in Operation 3, repair/replace the Passenger's Door Lock Switch. If the doors did not unlock in Operation 3, perform Test C
6. Get in the car and close and lock all doors Turn the Ignition Switch to RUN	Doors remain locked	None, proceed to Operation 7
	Doors unlock	Repair/replace the Central Locking Control Unit
7. Get out of the car Insert the key in the Driver's door and turn to LOCK Unlock each of the doors by pulling up the Safety Catch Buttons	All doors can be unlocked	None, proceed to Operation 8
	All doors remain secure	Disconnect the connector from the Central Locking Control Unit and check for a short to ground in the wires at terminal 11. <ul style="list-style-type: none"> <li>• If short to ground is not present, replace the Central Locking Control Unit.</li> <li>• If short to ground is present isolate wiring from Door Lock Motors one at a time to find short</li> </ul>

## 5126A-2 CENTRAL LOCKING

### SYSTEM CHECK TABLE (CONT'D)

OPERATION	RESPONSE	REPAIR ACTION
8. Insert the key in the Trunk Cylinder Switch. Turn the key to LOCK	Trunk locks	None, proceed to Operation 9
	Trunk does not lock	If the doors lock, repair/replace the Trunk Lock Motor Circuit or Trunk Lock Motor If the doors do not lock, repair/replace the Trunk Switch Repair/replace the Central Locking Control Unit if the Trunk Switch Circuit is OK
9. Turn the key to UNLOCK	Trunk unlocks	None, proceed to Operation 10
	Trunk does not unlock	If the doors unlock, repair/replace the Trunk Lock Motor circuit or Trunk Lock Motor If the doors do not unlock, repair/replace the Trunk Switch Repair/replace the Central Locking Control Unit if the Trunk Switch Circuit is OK
10. Turn the key back to LOCK	Gas Filler locks	None, proceed to Operation 11
	Gas Filler does not lock	Repair/replace the Gas Filler Lock Motor circuit
11. Turn the key to UNLOCK	Gas Filler unlocks	None
	Gas Filler does not unlock	Repair/replace the Gas Filler Lock Motor circuit

- If all results are normal, the system is OK.

### SYSTEM DIAGNOSIS

- Do the following tests when directed by the System Check Table.

#### A: CONTROL UNIT LOCK TEST (TABLE 1)

Measure: VOLTAGE At: CONTROL UNIT CONNECTOR (Connected)		
Measure Between	Correct Voltage	For Diagnosis
3 & Ground	Battery	See 1
3 & 4	Battery	See 2
<ul style="list-style-type: none"> <li>If the voltages are correct, proceed to Table 2.</li> </ul> <ol style="list-style-type: none"> <li>Check the wire to terminal 3 for an open.</li> <li>Check the wire from terminal 4 for an open to ground (see schematic).</li> </ol>		

#### A: CONTROL UNIT LOCK TEST (TABLE 2)

Connect: A FUSED JUMPER At: CONTROL UNIT CONNECTOR (Connected)		
Jumper Between	Correct Result	For Diagnosis
7 & Ground	Doors lock	See 1
<ul style="list-style-type: none"> <li>If the result is correct, repair/replace the switches and related wiring (see schematic).</li> </ul> <ol style="list-style-type: none"> <li>Proceed to Table 3.</li> </ol>		

**A: CONTROL UNIT LOCK TEST  
(TABLE 3)**

Connect: FUSED JUMPERS At: CONTROL UNIT CONNECTOR (Disconnected)		
Jumper Between	Correct Result	For Diagnosis
1 & 3 2 & 4	Doors lock	See 1
<ul style="list-style-type: none"> <li>If the result is correct, replace the Central Locking Control Unit.</li> </ul> <ol style="list-style-type: none"> <li>Check the wire from terminal 1 to splice and the wire from terminal 3 to splice for opens (see schematic).</li> </ol>		

**B: UNLOCK INHIBIT TEST**

Connect: A FUSED JUMPER At: CONTROL UNIT CONNECTOR (Connected)		
Jumper Between	Correct Result	For Diagnosis
10 & Ground	Doors double lock	See 1
<ul style="list-style-type: none"> <li>If the result is correct, check the wires from terminal 10 to ground for opens (see schematic). Replace the Unlock Inhibit Switch if the wires and connections are OK.</li> </ul> <ol style="list-style-type: none"> <li>Check the wires from terminal 11 for opens (see schematic). Replace the Central Locking Control Unit, if the wires and connections are OK.</li> </ol>		

**C: CONTROL UNIT UNLOCK TEST**

Connect: A FUSED JUMPER At: CONTROL UNIT CONNECTOR (Connected)		
Jumper Between	Correct Result	For Diagnosis
6 & Ground	Doors unlock	See 1
<ul style="list-style-type: none"> <li>If the result is correct, repair/replace the switches and related wiring (see schematic).</li> </ul> <ol style="list-style-type: none"> <li>Replace the Central Locking Control Unit.</li> </ol>		

**CIRCUIT DESCRIPTION**

The Central Locking System is controlled by the Central Locking Control Unit. This unit senses when a lock switch is moved by a key, and sends the appropriate signal to drive the Motors. The Central Locking Control Unit controls the Door Locks, Gas Filler Lock and Trunk Lock. The unit also has an Inertia Switch which closes on impact greater than 5g. If in RUN or START the locks are then unlocked.

**Lock**

When the Key is inserted into a lock and turned clockwise, the Lock switch moves to LOCK and grounds terminal 7 of the Central Locking Control Unit. The unit then activates the Lock Relay and applies voltage from Fuse 27 to the Lock Motor, which is grounded through the Central Locking Control Unit terminal 2. The Lock Motor then pulls the lock down. The door locks also control the Trunk Lock and Gas Filler Lock.

**Unlock**

When the key is turned counterclockwise, terminal 6 of the Central Locking Control Unit is grounded through the Lock Switch. The Central Locking Control Unit then activates the Unlock Relay and applies voltage from Fuse 27, through terminal 2 to the Lock Motor. The motor is grounded through the Central Locking Control Unit terminal 1. The polarity is reversed and the motor pushes the lock up.

**Unlock Inhibit**

When the key is inserted into the Driver's Lock and turned clockwise past the LOCK position, the Unlock Inhibit mechanism is engaged. This mechanically inserts a bar into the driver's lock and prevents unlocking through use of the Safety Catch Button. When in the Unlock Inhibit position, ground is applied to the Unlock Inhibit motors in the other lock units. The Central Locking Control Unit is grounded at terminal 10 and then activates the Lock Relay. Voltage is applied to the Unlock Inhibit motors through terminal 1. They are now activated and engage the other Unlock Inhibit mechanisms. The direction of the motors is reversed when the doors are unlocked (see Unlock).

**Trunk Lock**

The Trunk Lock operates in a manner similar to the Door Locks.

# 5133-0 POWER WINDOWS

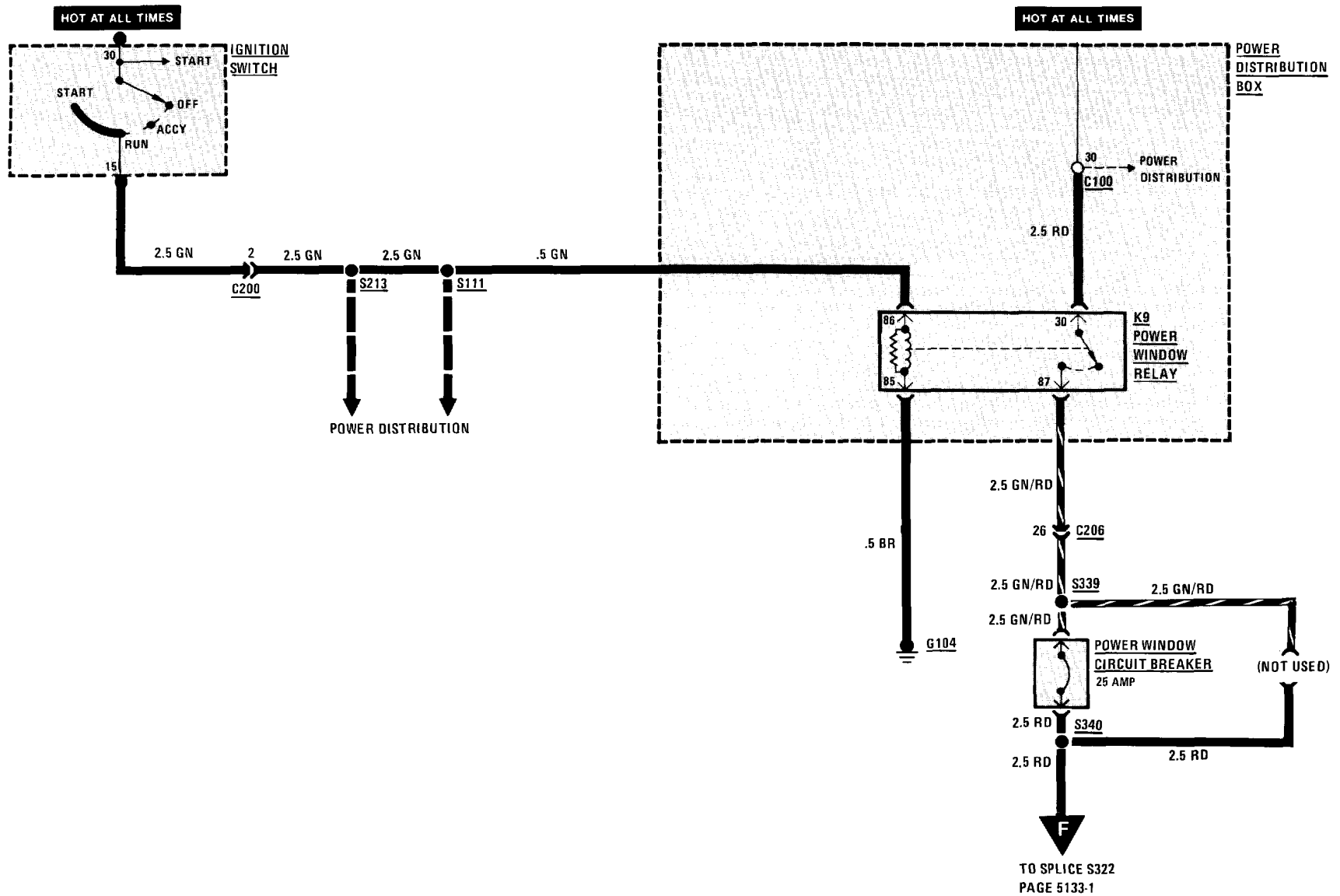

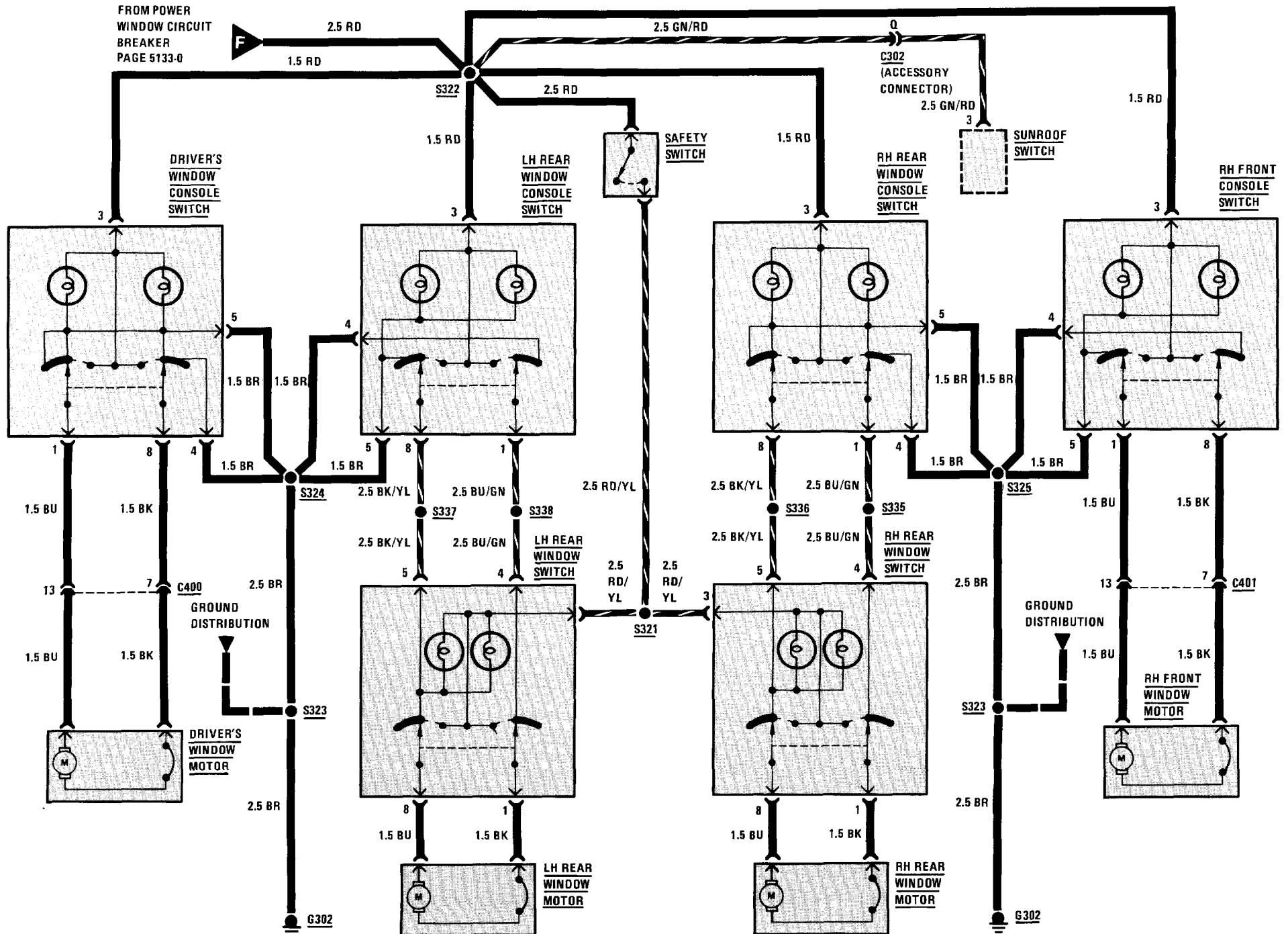

# 5200-0 POWER SEATS

## DRIVER'S MEMORY SEAT

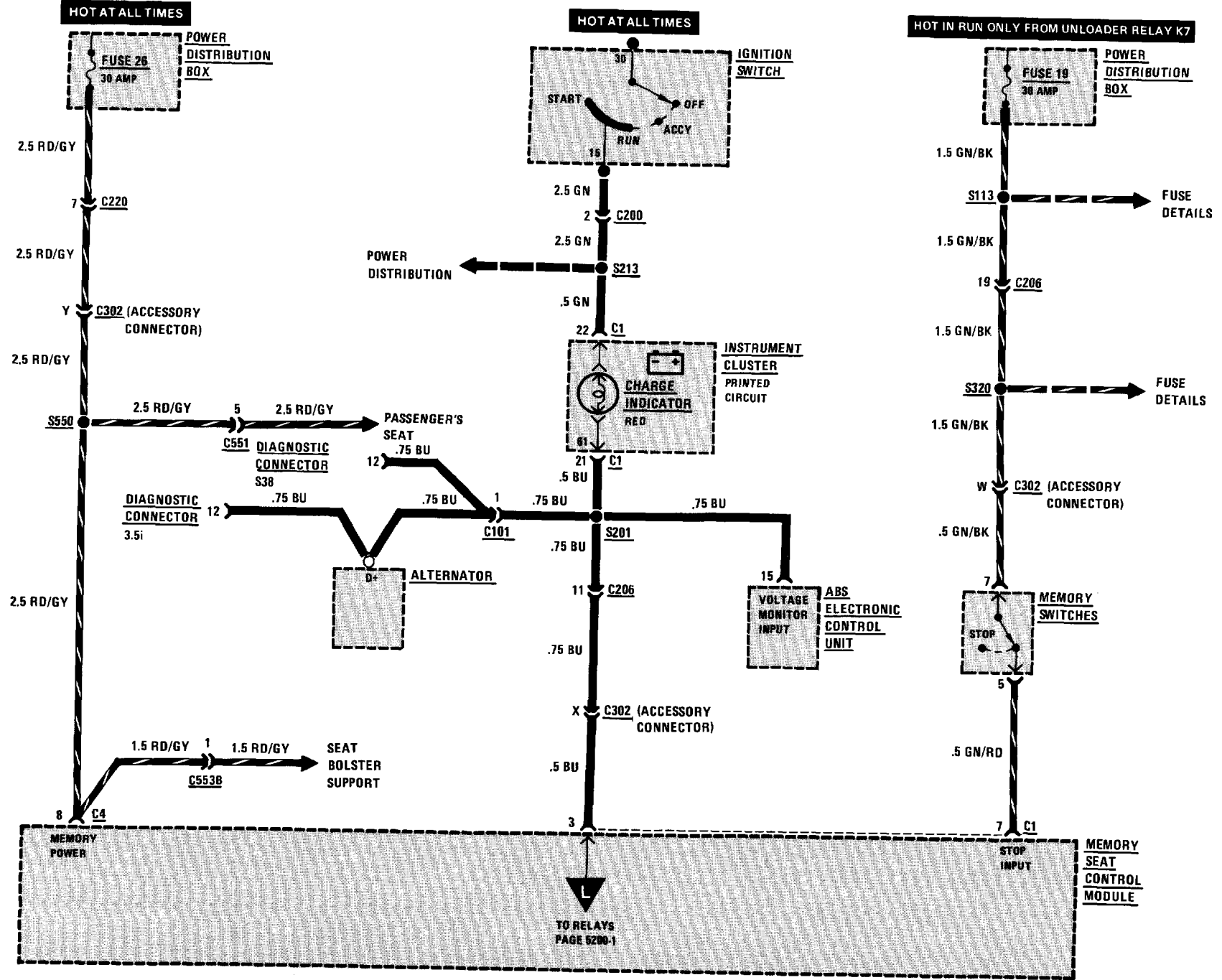

MEMORY SEAT CONTROL MODULE

DRIVER'S MEMORY SEAT

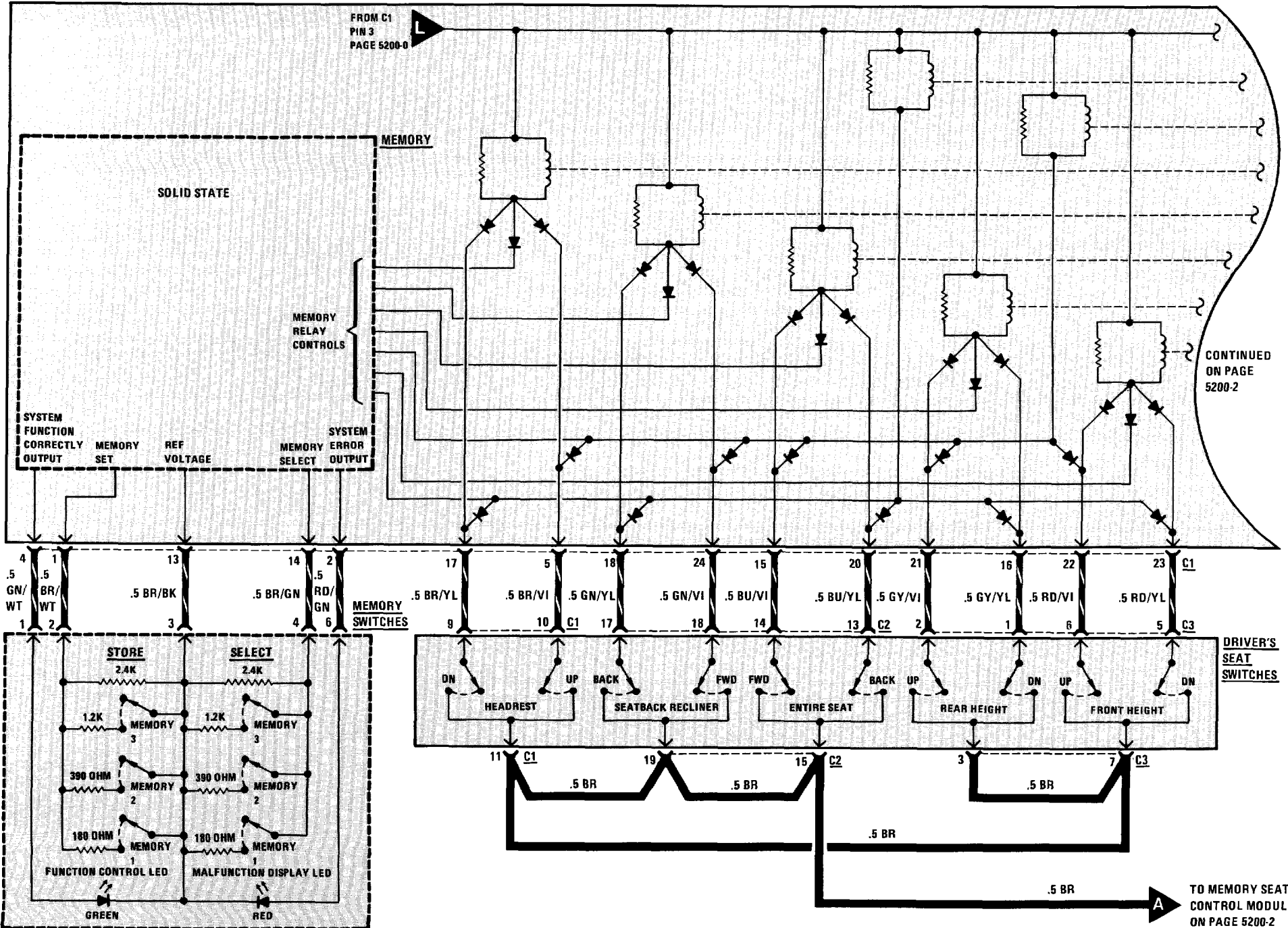

# 5200-2 POWER SEATS

## DRIVER'S MEMORY SEAT

CONTINUED FROM PAGE 5200-1

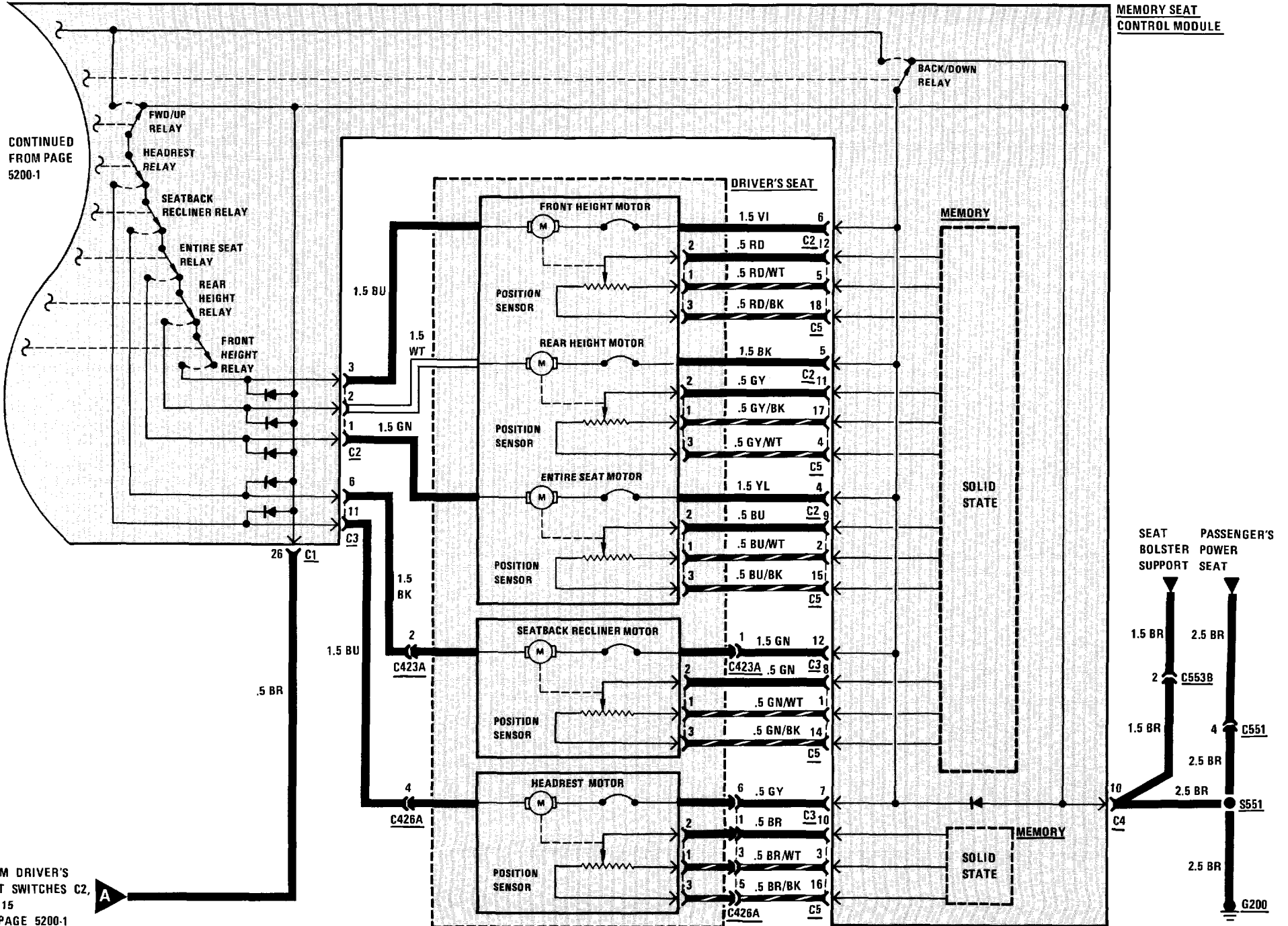

FROM DRIVER'S SEAT SWITCHES C2, PIN 15 ON PAGE 5200-1



PASSENGER'S SEAT

PASSENGER'S SEAT CONTROLLER

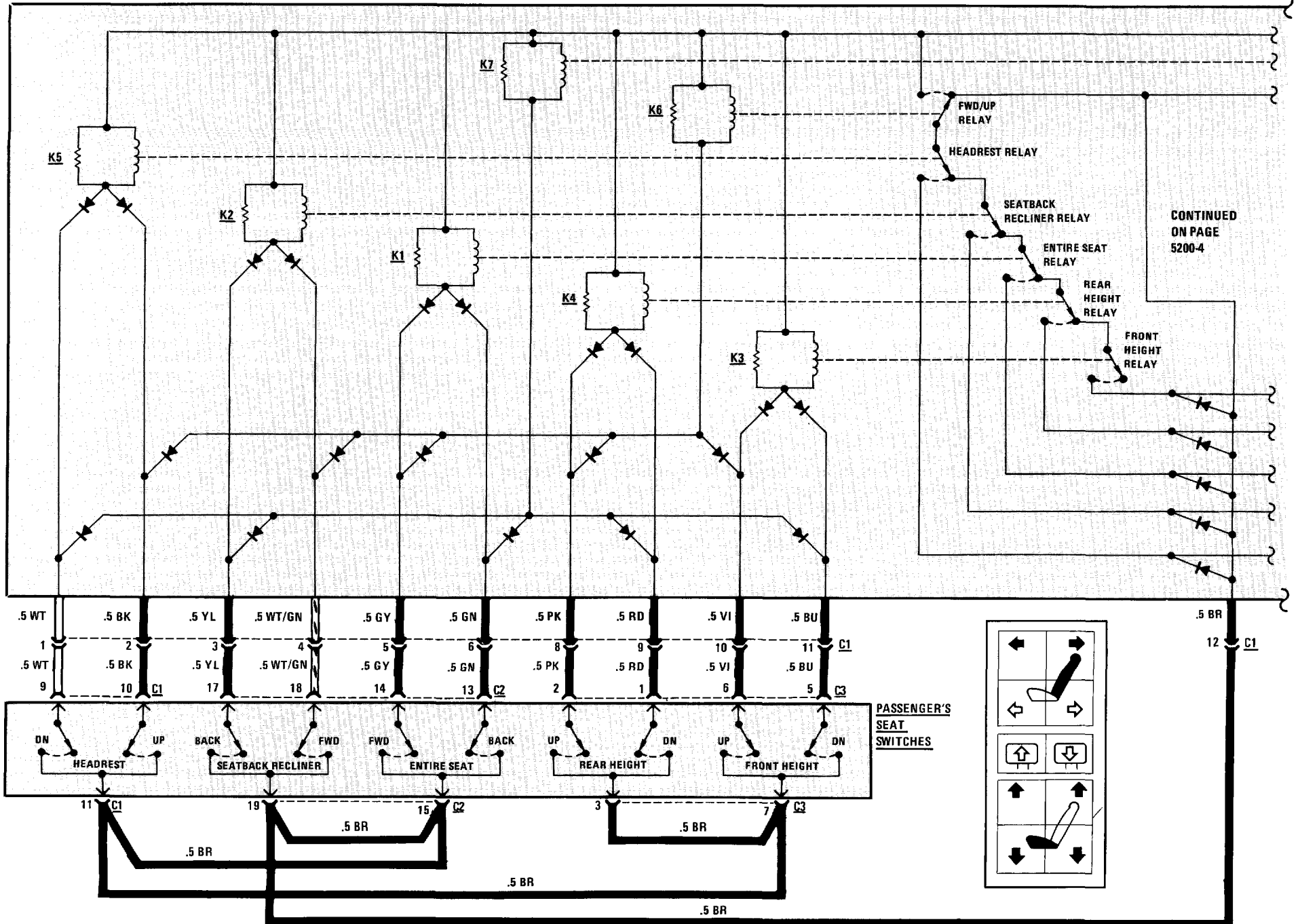

# 5200-4 POWER SEATS

## PASSENGER'S SEAT

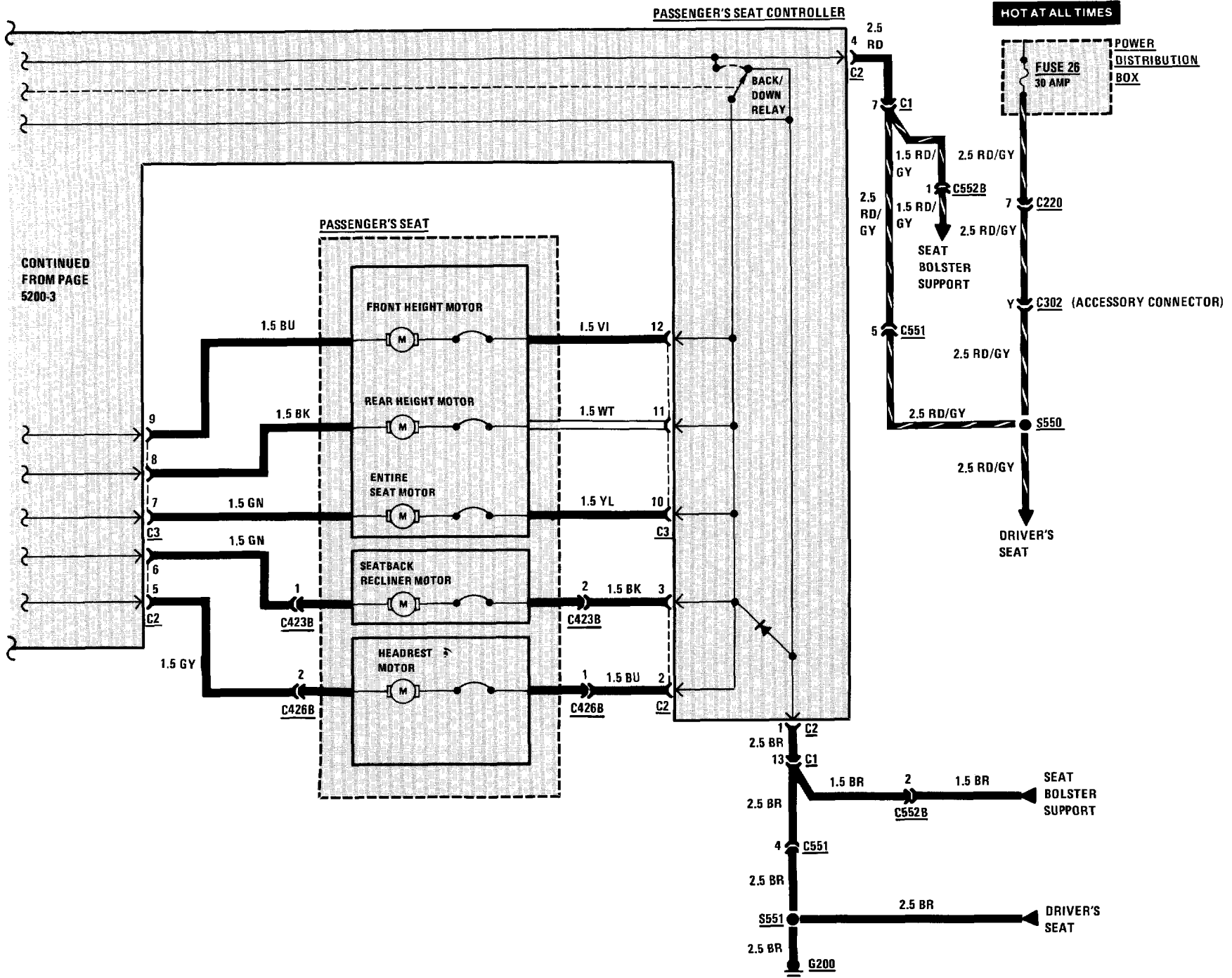

SEAT BOLSTER SUPPORT

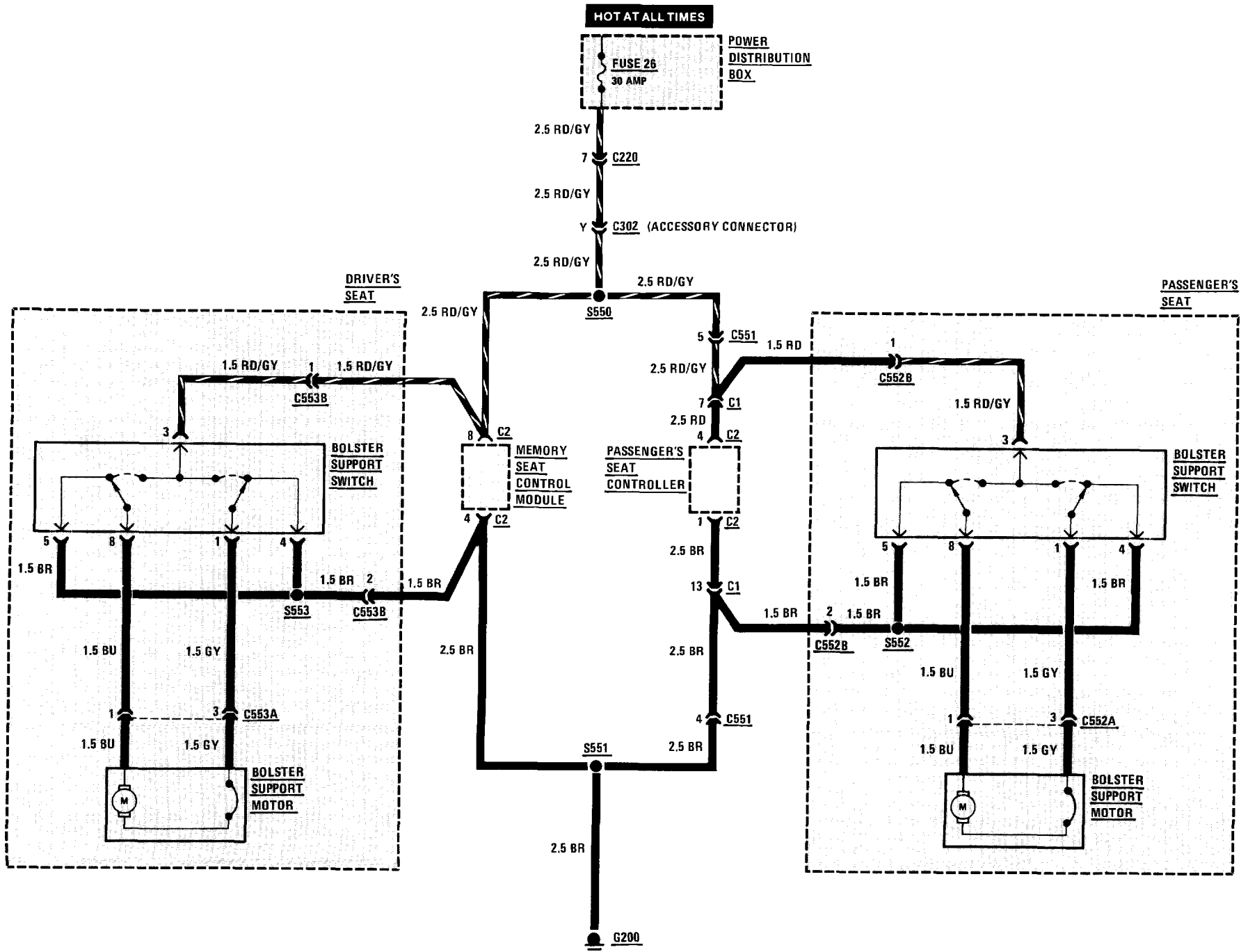

# 5200-6 POWER SEATS

## HEATED SEATS

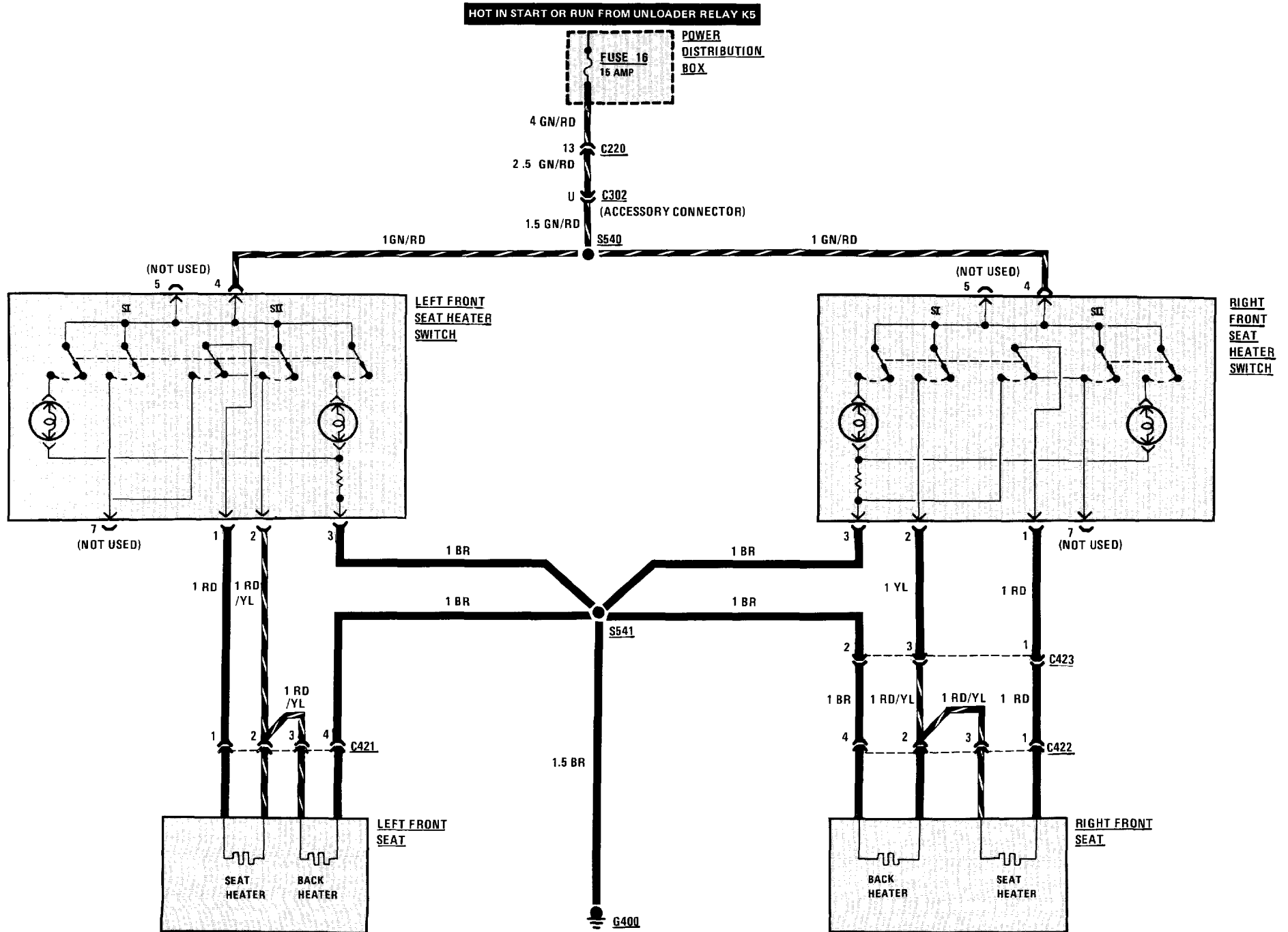

### CIRCUIT OPERATION

#### Driver's Seat and Passenger's Seat - Manual Operation

There are five reversible Motors that operate the Power Seat. The seat height is controlled by two Motors: one for Front Height and the other for Rear Height; these two Motors operate independently of each other. The other three Motors provide positioning for Headrest Height, Seat-back Reclining, and the Entire Seat Forward/Backward.

When any Seat Switch is depressed, a path to ground is provided for two Relays inside the Control Unit. One Relay controls the Motor for the seat function depressed and the other controls the polarity of the voltage to the Motor selected. An example of this action is as follows: The Front Height UP Switch is depressed, energizing the coils of the Front Height and Fwd/Up Relays. The Relay Switch contacts close and voltage is applied to the Front Height Motor. This drives the front of the seat up as long as the Front Height UP Switch is depressed, or until end of travel. When the Front Height Down Switch is depressed, the Front Height and the Back/Down Relays are energized. Polarity to the motor is reversed, which drives the seat down. The operation of the other seat functions is similar to the operation of the Front Height control.

#### Driver's Seat - Memory Operation

When operating the Memory Seats from the Seat Switches, operation is the same as the non-memory seats. When the memory functions are operated, the appropriate relays are grounded

through the Solid State circuits of the Control Unit rather than the Seat Switches.

Operation of the Memory Seat requires the Ignition Switch to be in ACCY or RUN.

The Memory Seat operates by storing voltages at the Motor Position Inputs of the Memory Seat Control Module. Voltage is applied to the Front Height Motor Position Sensor at terminal 1 and grounded through terminal 3. The input voltage of the Motor Position Sensor is supplied to the Memory Control Module through terminal 2. The input voltage will vary between 1 and 5 volts depending upon the location of the Front Height Motor. The Motor Position Sensor circuits of the other Seat Motors are similar to the Front Height Motor circuit. When any one of the Memory Select buttons is pressed, the Memory Control Module applies voltage to the Motors until the Memory Position Sensor input voltages equal those previously stored.

To store a seat position in memory, move the seat to the desired position and depress one of the three Memory Store Switches. The green LED will flash when the position is accepted in memory. When the Ignition is in ACCY or RUN and the engine is not running, the Memory Select Switches can be pressed momentarily to move the seat to a memory position. As the seat is moving to a memory position, the green LED will light until the seat reaches that position. When the engine is running, the desired Memory Select Switch must be depressed and held. During this Memory Seat operation, the green LED will flash until the seat has reached the position stored.

When the Stop Switch is depressed, memory functions are disabled. This action will disable the memory prior to and during memory positioning. Memory positioning will also be disrupted if any other Memory Select Switch is depressed during positioning.

When a fault occurs in the Memory Seat System, the red LED will flash after depressing any of the Memory Select Switches.

#### Seat Bolster Support

Voltage is applied to the Bolster Support Switch through Fuse 26 to terminal 3. When the Switch is operated, voltage is applied to the Bolster Support Motor through one set of Switch contacts. The path to ground is through the other set of contacts and the ground wires.

The direction in which the Switch is operated determines the polarity of the voltage, and the Bolster Support will extend or retract.

**TROUBLESHOOTING HINTS**

- Try the following checks before doing the System Check.
- 1. If both Power Seats do not operate, check Fuse 26 and the power lead to the splice.
- 2. Check Fuse 19 and wire to the Memory Switch.
- Go to System Check for a guide to normal operation.
- Go to System Diagnosis for diagnostic tests.

**SYSTEM CHECK**

- Use the System Check Table as a guide to normal operation.

**SYSTEM CHECK TABLE**

<b>ACTION</b>	<b>NORMAL RESULT</b>
1. Operate the Seatback Recliner Switch in the BACK and FWD positions.	Back of the seat moves backward and forward in response to operation of Seat Switch.
2. Operate the Rear Height Switch in the UP and DN positions.	The rear seat height moves up and down.
3. Operate the Front Height Switch in the UP and DN positions.	The front seat height moves up and down.
4. Operate the Entire Seat Switch in the FWD and BACK positions.	The seat moves forward and back.
5. Operate the Headrest Switch in the UP and DN positions.	The headrest moves up and down.

(Continued in next column)

(Continued from previous column)

6. Operate the Bolster Support Switch in the Extend and Retract positions.	The bolster support extends and retracts.
<b>NOTE: The following steps are for the LH Memory Seat only</b>	
7. Repeat steps 1 through 6 using the LH Seat Switch.	Results are the same.
8. Press the Store MEMORY 1 button (this will remove any previously stored seat position from the memory).	The current seat position is stored in memory (the green LED will flash when seat position is stored).
9. Using the Seat Switches, move the seat to a different position, then press MEMORY 1 button.	The seat automatically returns to the position stored in step 8.
10. Using the Seat Switches, move the seat to a new position, then press the Store MEMORY 2 button.	The new seat position is stored in memory (the green LED will flash when seat position is stored).
11. Move the seat to a different position, then press MEMORY 2 button.	The seat automatically returns to the position stored in step 10.
12. Using the Seat Switches, move the seat to a new position, then press the Store MEMORY 3 button.	The new seat position is stored in memory (the green LED will flash when seat position is stored).
13. Move the seat to a different position, then press MEMORY 3 button.	The seat automatically returns to the position stored in step 12.
14. Press MEMORY 1 button, and while the seat is moving, press the STOP button.	The seat stops before reaching the position stored in step 8.

- Refer to System Diagnosis when a result is not normal.

(Continued on next page)

## 5200A-2 POWER SEATS

(Continued from previous page)

### SYSTEM DIAGNOSIS

- Diagnostic steps for the symptoms listed in the following table are listed after the table.

#### SYMPTOM TABLE

A: No seat functions work
B: Some seat functions work
C: Memory functions do not work
D: Bolster support does not work

#### A: NO SEAT FUNCTIONS WORK (TABLE 1 - SEAT WITHOUT MEMORY)

<b>Measure: VOLTAGE</b>		
<b>At: PASSENGER'S SEAT CONTROLLER CONNECTORS C1 &amp; C2 (Connected)</b>		
Measure Between	Correct Voltage	For Diagnosis
C2/4 & Ground	Battery	See 1
C2/4 & C2/1	Battery	See 2
C2/4 & C1/12	Battery	See 3
<ul style="list-style-type: none"> <li>If all voltages are correct, go to Test B.</li> </ul> <ol style="list-style-type: none"> <li>Check wire to connector C2, terminal 4 (see schematic). Check Fuse 26.</li> <li>Check wire from connector C2, terminal 1 (see schematic). Check ground G200.</li> <li>Replace Passenger's Seat Controller.</li> </ol>		

#### A: NO SEAT FUNCTIONS WORK (TABLE 2 - SEAT WITH MEMORY)

<b>Measure: VOLTAGE</b>		
<b>At: MEMORY SEAT CONTROL MODULE CONNECTORS C1 (26-pin Connecting Lead and Universal Adapter Connected) &amp; C4 (Connected)</b>		
<b>Condition:</b>		
<ul style="list-style-type: none"> <li>Ignition Switch: RUN</li> </ul>		
Measure Between	Correct Voltage	For Diagnosis
C4/8 & Ground	Battery	See 1
C4/8 & C4/10	Battery	See 2
C1/3 & Ground	Battery	See 3
C1/3 & C1/26	Battery	See 4
<ul style="list-style-type: none"> <li>If all voltages are correct, go to Test B.</li> </ul> <ol style="list-style-type: none"> <li>Check wire to connector C4, terminal 84 for an open (see schematic). Check Fuse 26.</li> <li>Check wire from connector C4, terminal 10 for an open (see schematic). Check ground G200.</li> <li>Check wire to connector C1, terminal 3 for an open (see schematic).</li> <li>Replace Memory Seat Control Module.</li> </ol>		

#### B: SOME SEAT FUNCTIONS WORK (TABLE 1 - SEAT WITHOUT MEMORY)

<b>Measure: RESISTANCE</b>		
<b>At: PASSENGER'S SEAT CONTROLLER CONNECTOR C1 (Disconnected)</b>		
<b>Condition:</b>		
<ul style="list-style-type: none"> <li>Headrest Switch: DOWN</li> </ul>		
Measure Between	Correct Resistance	For Diagnosis
1 (female) & 12 (female)	0 Ohms	See 1
<ul style="list-style-type: none"> <li>Headrest Switch: UP</li> </ul>		
2 (female) & 12 (female)	0 Ohms	See 1
<ul style="list-style-type: none"> <li>Seatback Recliner Switch: BACK</li> </ul>		
3 (female) & 12 (female)	0 Ohms	See 1
<ul style="list-style-type: none"> <li>Seatback Recliner Switch: FWD</li> </ul>		
4 (female) & 12 (female)	0 Ohms	See 1
<ul style="list-style-type: none"> <li>Entire Seat Switch: FWD</li> </ul>		
5 (female) & 12 (female)	0 Ohms	See 1
<ul style="list-style-type: none"> <li>Entire Seat Switch: BACK</li> </ul>		
6 (female) & 12 (female)	0 Ohms	See 1
<ul style="list-style-type: none"> <li>Rear Height Switch: UP</li> </ul>		
8 (female) & 12 (female)	0 Ohms	See 1
<ul style="list-style-type: none"> <li>Rear Height Switch: DN</li> </ul>		
9 (female) & 12 (female)	0 Ohms	See 1

(Continued on next page)

(Continued from previous page)

• Front Height Switch: UP		
10 (female) & 12 (female)	0 Ohms	See 1
• Front Height Switch: DN		
11 (female) & 12 (female)	0 Ohms	See 1
• If all results are correct, reconnect connector and go to Table 2. 1. Check wire to Passenger's Seat Switches (see schematic). If wire is good, replace Passenger's Seat Switches.		

**B: SOME SEAT FUNCTIONS WORK (TABLE 2 - SEAT WITHOUT MEMORY)**

<b>Measure: VOLTAGE</b>		
<b>At: PASSENGER'S SEAT CONTROLLER CONNECTORS C2 &amp; C3 (Connected)</b>		
<b>Condition:</b>		
• Headrest Switch: UP and DN		
<b>Measure Between</b>	<b>Correct Voltage</b>	<b>For Diagnosis</b>
C2/2 & C2/5	Battery	See 1
• Seatback Recliner Switch: FWD and BACK		
C2/3 & C2/6	Battery	See 1
• Entire Seat Switch: FWD and BACK		
C3/7 & C3/10	Battery	See 1
• Rear Switch: UP and DN		
C3/8 & C3/11	Battery	See 1
• Front Switch: UP and DN		
C3/9 & C3/12	Battery	See 1
• If all voltages are correct, repair/replace suspect Motor. 1. Replace Passenger's Seat Controller.		

**B: SOME SEAT FUNCTIONS WORK (TABLE 3 - SEAT WITH MEMORY)**

<b>Measure: RESISTANCE</b>		
<b>At: MEMORY SEAT CONTROL MODULE CONNECTOR C1 (Disconnected)</b>		
<b>Condition:</b>		
• Headrest Switch: DOWN		
<b>Measure Between</b>	<b>Correct Voltage</b>	<b>For Diagnosis</b>
17 & 26	0 Ohms	See 1
• Headrest Switch: UP		
5 & 26	0 Ohms	See 1
• Seatback Recliner Switch: BACK		
18 & 26	0 Ohms	See 1
• Seatback Recliner Switch: FWD		
24 & 26	0 Ohms	See 1
• Entire Seat Switch: FWD		
15 & 26	0 Ohms	See 1
• Entire Seat Switch: BACK		
20 & 26	0 Ohms	See 1
• Rear Height Switch: UP		
21 & 26	0 Ohms	See 1
• Rear Height Switch: DN		
16 & 26	0 Ohms	See 1
• Front Height Switch: UP		
22 & 26	0 Ohms	See 1
• Front Height Switch: DN		
23 & 26	0 Ohms	See 1
• If all resistances are correct, reconnect connector and go to Table 2. 1. Check wire to Driver's Seat Switches (see schematic). If wire is good, replace Driver's Seat Switches.		

**B: SOME SEAT FUNCTIONS WORK (TABLE 4 - SEAT WITH MEMORY)**

<b>Measure: VOLTAGE</b>		
<b>At: MEMORY SEAT CONTROL MODULE CONNECTORS C2 &amp; C3 (Connected)</b>		
<b>Condition:</b>		
• Headrest Switch: UP and DN		
<b>Measure Between</b>	<b>Correct Voltage</b>	<b>For Diagnosis</b>
C3/11 & C3/7	Battery	See 1
• Seatback Recliner Switch: FWD and BACK		
C3/6 & C3/12	Battery	See 1
• Entire Seat Switch: FWD and BACK		
C2/1 & C2/4	Battery	See 1
• Rear Height Switch: UP and DN		
C2/5 & C2/2	Battery	See 1
• Front Height Switch: UP and DN		
C2/3 & C2/6	Battery	See 1
• If all voltages are correct, repair/replace suspect motor. 1. Replace Memory Seat Control Module.		

(Continued on next page)



## 5200A-4 POWER SEATS

(Continued from previous page)

### C: MEMORY FUNCTIONS DO NOT WORK (TABLE 1 - SEAT WITH MEMORY)

<b>Measure: RESISTANCE</b>		
<b>At: MEMORY SWITCHES CONNECTOR (Disconnected)</b>		
<b>Condition:</b>		
• STOP Switch: PRESSED		
Measure Between	Correct Resistance	For Diagnosis
5 & 7	Infinite Ohms	See 1
• STOP Switch: RELEASED		
5 & 7	0 Ohms	See 1
2 & 3	Approximately 2.2 K Ohms	See 1
3 & 4	Approximately 2.2K Ohms	See 1
• MEMORY 1: PRESSED		
3 & 4	Approximately 170 Ohms	See 1
• MEMORY 2: PRESSED		
3 & 4	Approximately 340 Ohms	See 1
• MEMORY 3: PRESSED		
3 & 4	Approximately 800 Ohms	See 1
• Store MEMORY 1: PRESSED		
2 & 3	Approximately 170 Ohms	See 1
• Store MEMORY 2: PRESSED		

(Continued in next column)

(Continued from previous column)

2 & 3	Approximately 340 Ohms	See 1
• Store MEMORY 3: PRESSED		
2 & 3	Approximately 800 Ohms	See 1
• If all resistances are correct, go to Table 2.		
1. Replace Memory Switches.		

### C: MEMORY FUNCTIONS DO NOT WORK (TABLE 2 - SEAT WITH MEMORY)

<b>Measure: VOLTAGE</b>		
<b>At: MEMORY SEAT CONTROL MODULE CONNECTOR C5 (26-pin Connecting Lead And Universal Adapter) (Connected)</b>		
<b>Condition:</b>		
• Ignition Switch: RUN		
Measure Between	Correct Voltage	For Diagnosis
3 & 16	Greater than 4 Volts	See 1
1 & 14	Greater than 4 Volts	See 1
2 & 15	Greater than 4 Volts	See 1
4 & 17	Greater than 4 Volts	See 1
5 & 18	Greater than 4 Volts	See 1
• If all voltages are correct, go to Table 3.		
1. Replace Memory Seat Control Module.		

### C: MEMORY FUNCTIONS DO NOT WORK (TABLE 3 - SEAT WITH MEMORY)

<b>Measure: VOLTAGE</b>		
<b>At: MEMORY SEAT CONTROL MODULE CONNECTOR C5 (26-pin Connecting Lead And Universal Adapter) (Connected)</b>		
<b>Conditions:</b>		
• Ignition Switch: RUN		
• Headrest Switch: UP or DOWN		
Measure Between	Correct Voltage	For Diagnosis
10 & Ground	Varies between 1 & 5 Volts	See 1
• Seatback Recliner Switch: FWD or BACK		
8 & Ground	Varies between 1 & 5 Volts	See 1
• Entire Seat Switch: FWD or BACK		
9 & Ground	Varies between 1 & 5 Volts	See 1
• Rear Height Switch: UP or DOWN		
11 & Ground	Varies between 1 & 5 Volts	See 1
• Front Height Switch: UP or DOWN		
12 & Ground	Varies between 1 & 5 Volts	See 1
• If all voltages are correct, replace Memory Seat Control Module.		
1. Check wire to Position Sensor (see schematic). If wire is good, replace Position Sensor.		

**D: BOLSTER SUPPORT DOES NOT WORK (TABLE 1)**

<b>Measure: VOLTAGE</b>		
<b>At: BOLSTER SUPPORT SWITCH CONNECTOR (Connected)</b>		
<b>Measure Between</b>	<b>Correct Voltage</b>	<b>For Diagnosis</b>
3 & Ground	Battery	See 1
3 & 4	Battery	See 2
3 & 5	Battery	See 2
<ul style="list-style-type: none"> <li>• Bolster Support Switch: EXTEND and RETRACT</li> </ul>		
8 & 1	Battery	See 3
<ul style="list-style-type: none"> <li>• If all voltages are correct, go to Table 2.</li> </ul> <ol style="list-style-type: none"> <li>1. Check wires to terminal 3 and Fuse 26 (see schematic).</li> <li>2. Check wire from terminal 4 or 5, and ground G200 (see schematic).</li> <li>3. Replace Bolster Support Switch.</li> </ol>		

**D: BOLSTER SUPPORT DOES NOT WORK (TABLE 2)**

<b>Measure: VOLTAGE</b>		
<b>At: BOLSTER SUPPORT MOTOR CONNECTOR (Connected)</b>		
<b>Condition:</b>		
<ul style="list-style-type: none"> <li>• Bolster Support Switch: EXTEND and RETRACT</li> </ul>		
<b>Measure Between</b>	<b>Correct Voltage</b>	<b>For Diagnosis</b>
1 & 3	Battery	See 1
<ul style="list-style-type: none"> <li>• If the voltage is correct, replace Bolster Support Motor.</li> </ul> <ol style="list-style-type: none"> <li>1. Check/repair wires to the Bolster Support Switch.</li> </ol>		

# 5413-0 SUNROOF

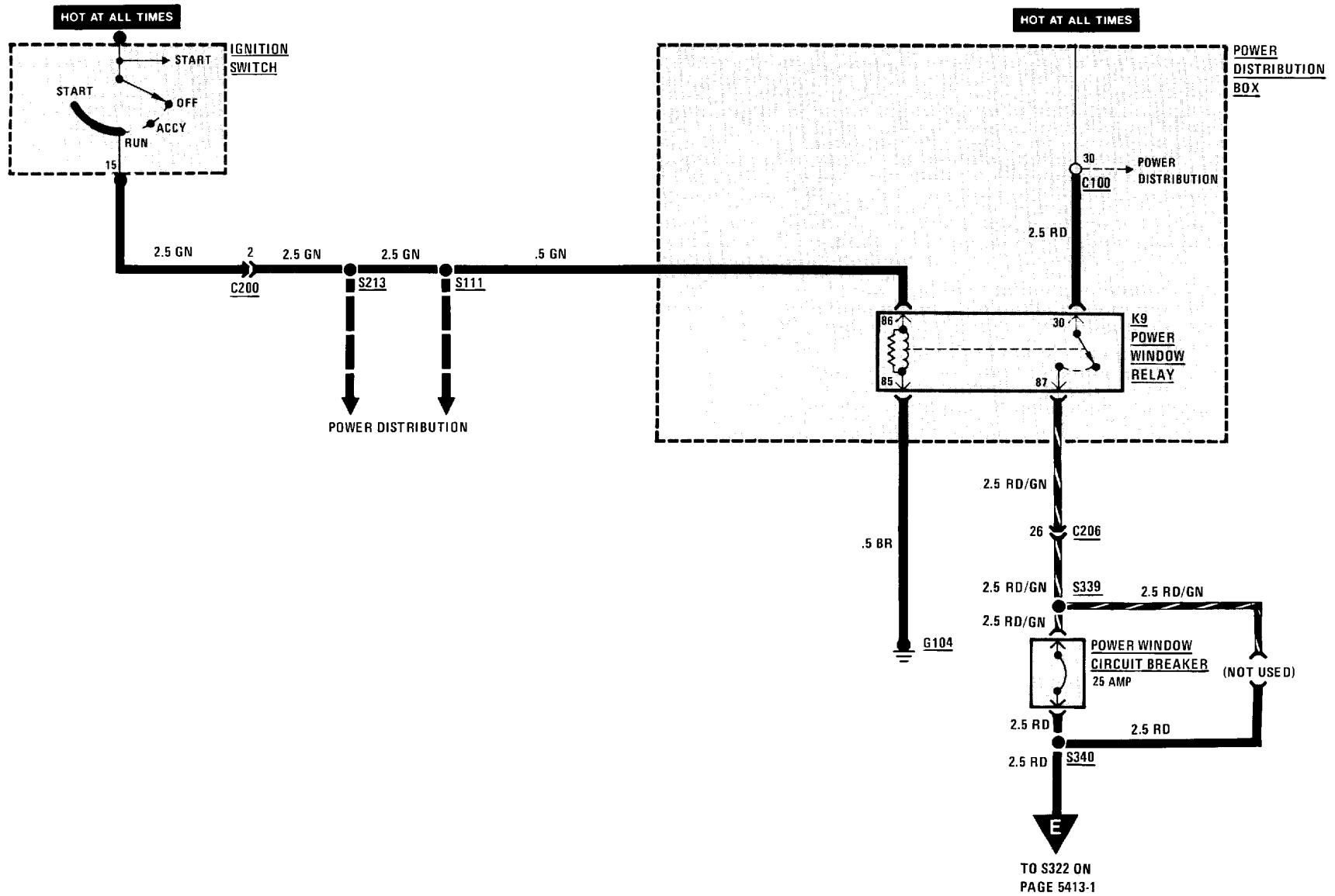

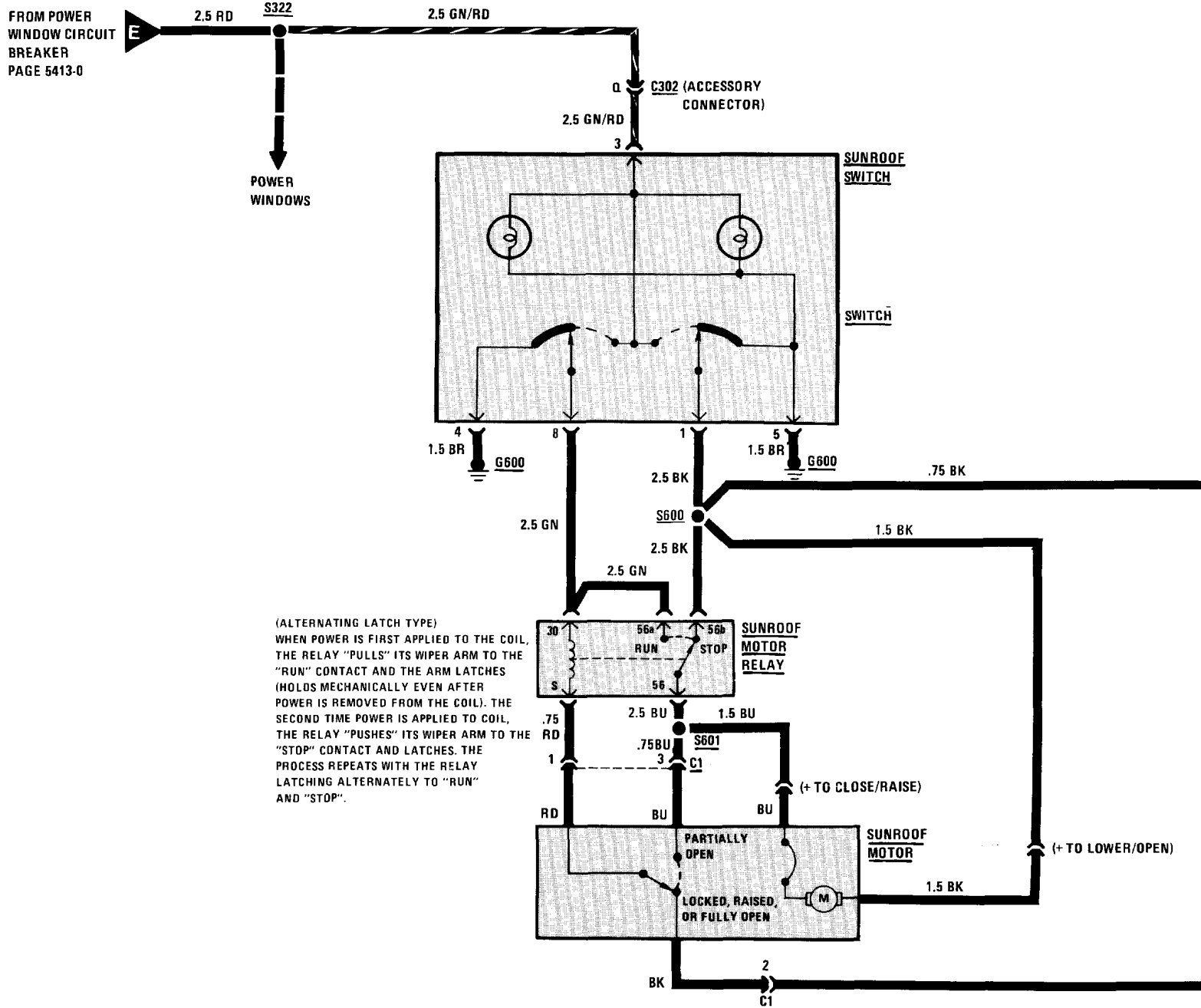

**HORN**

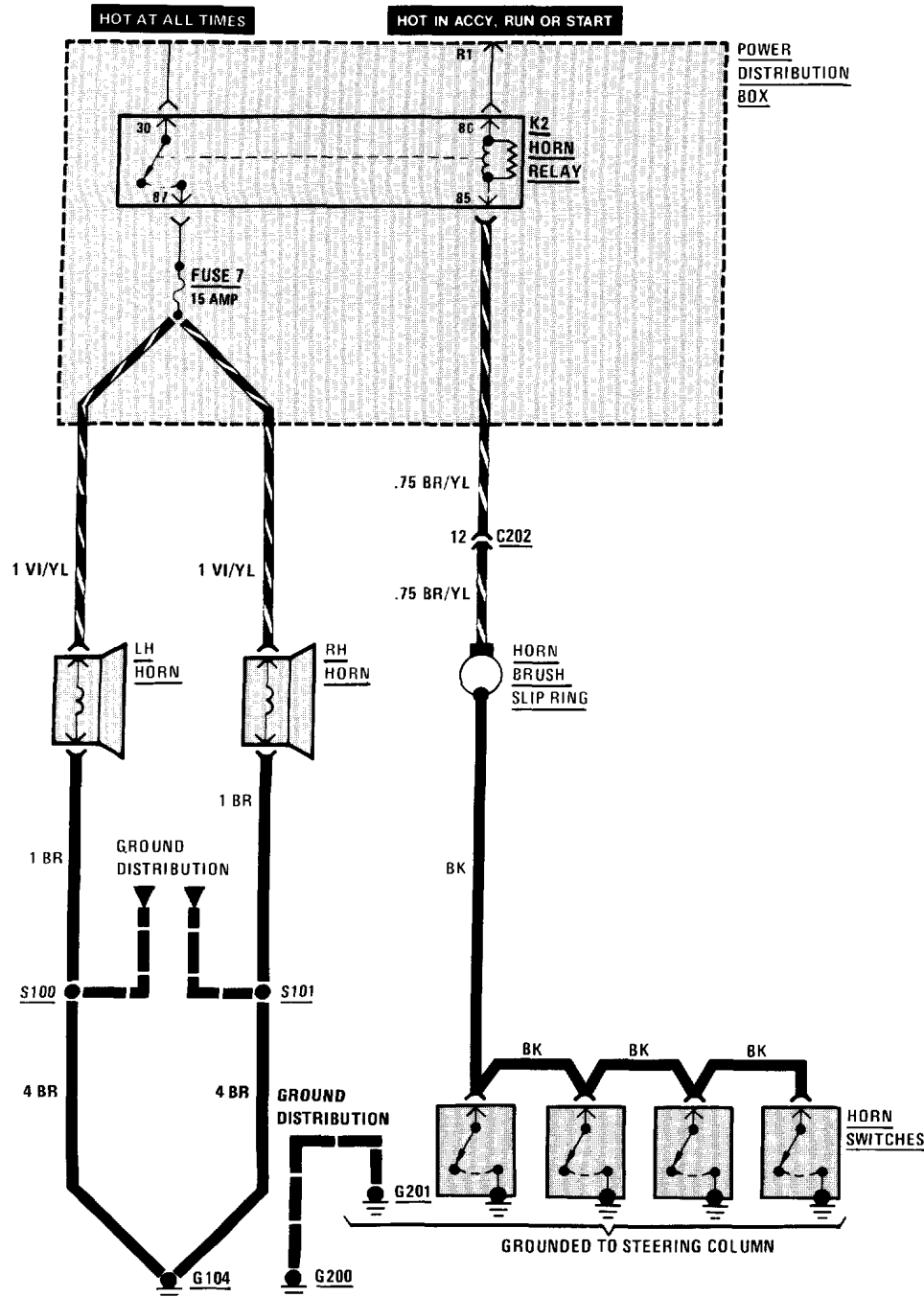

**HEATED DOOR LOCK**

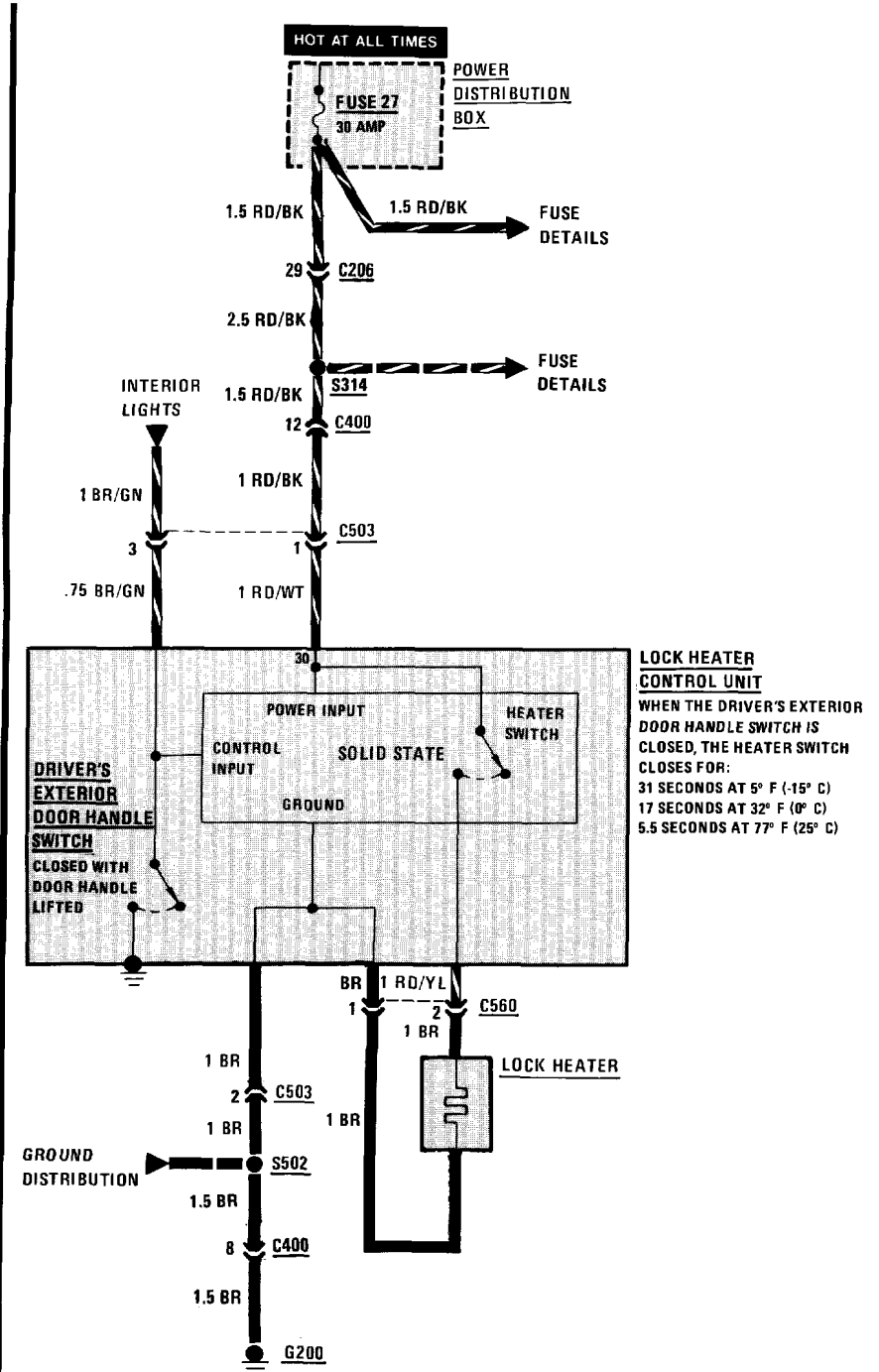

REAR DEFOGGER

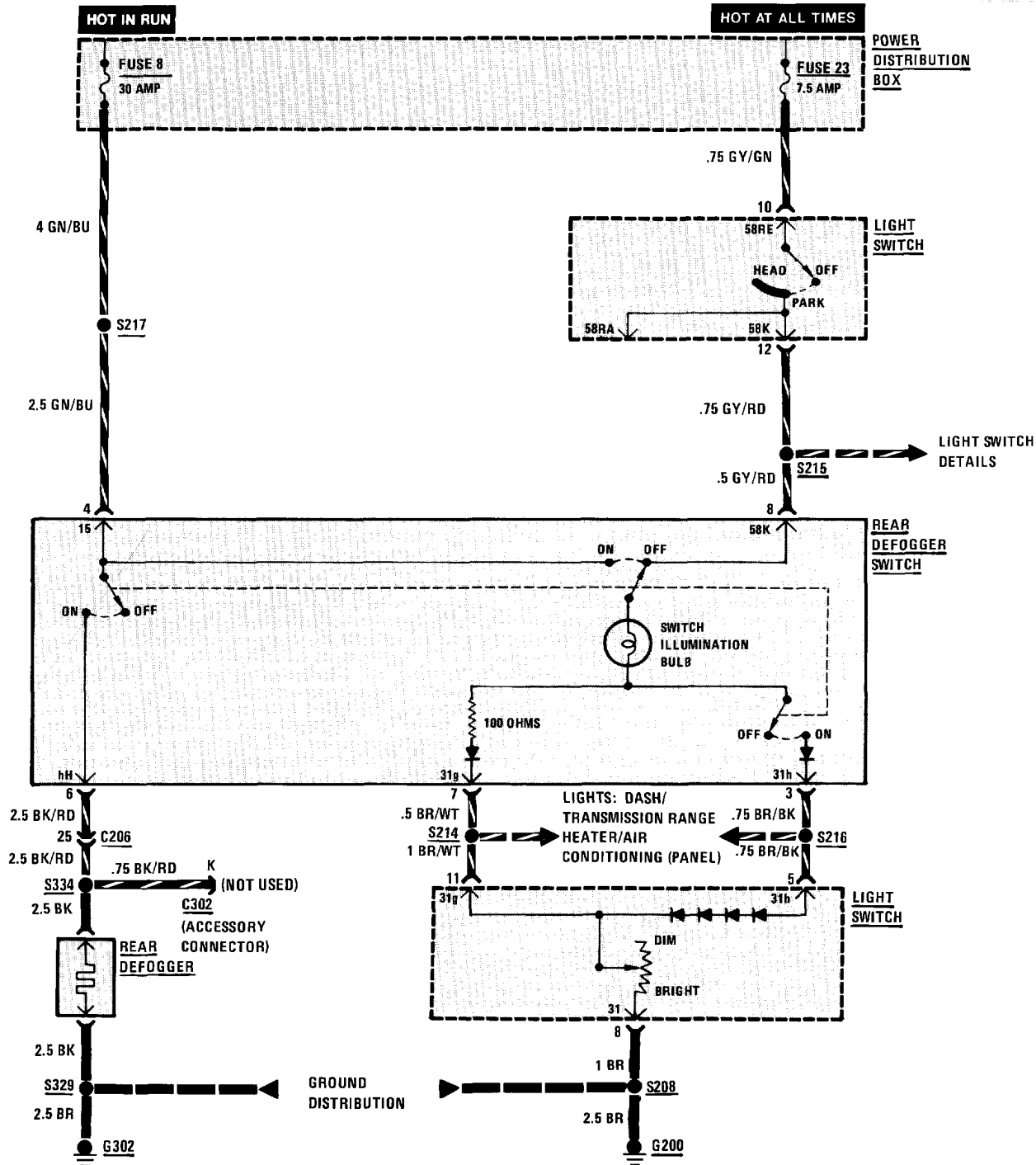

**CIGAR LIGHTER/GLOVE BOX LIGHT/AUTO-CHARGING FLASHLIGHT**

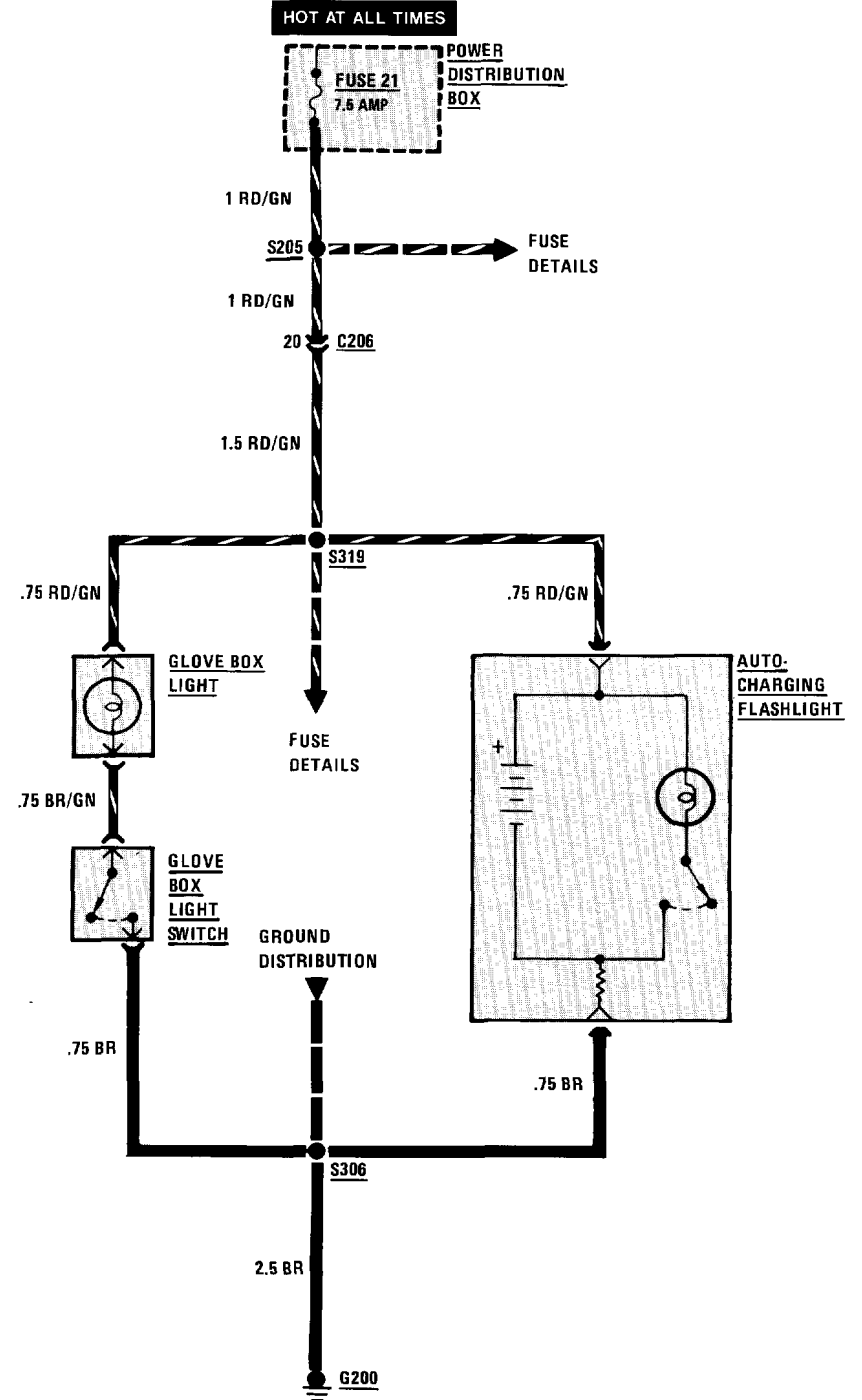
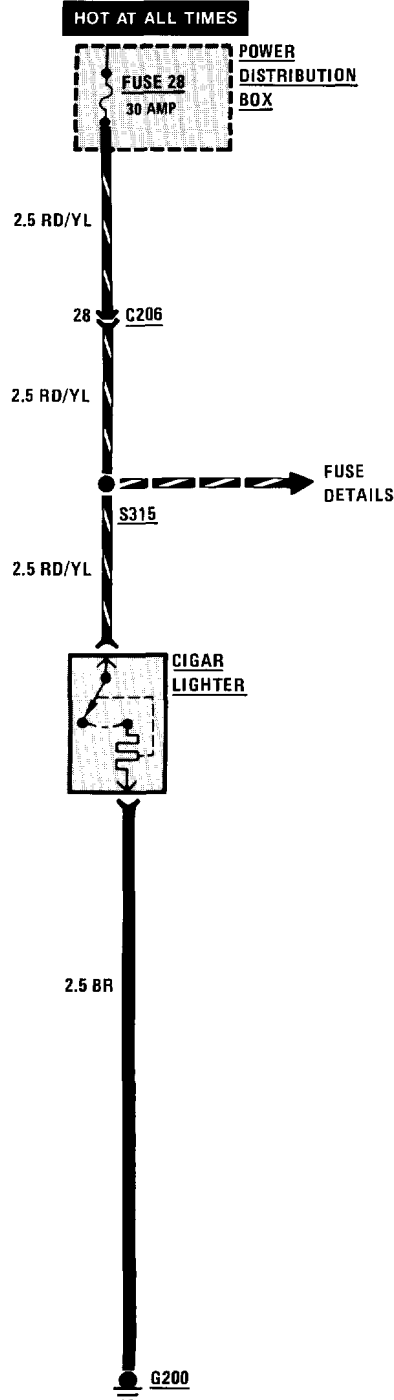

# 6131-0 IGNITION KEY WARNING/SEATBELT WARNING

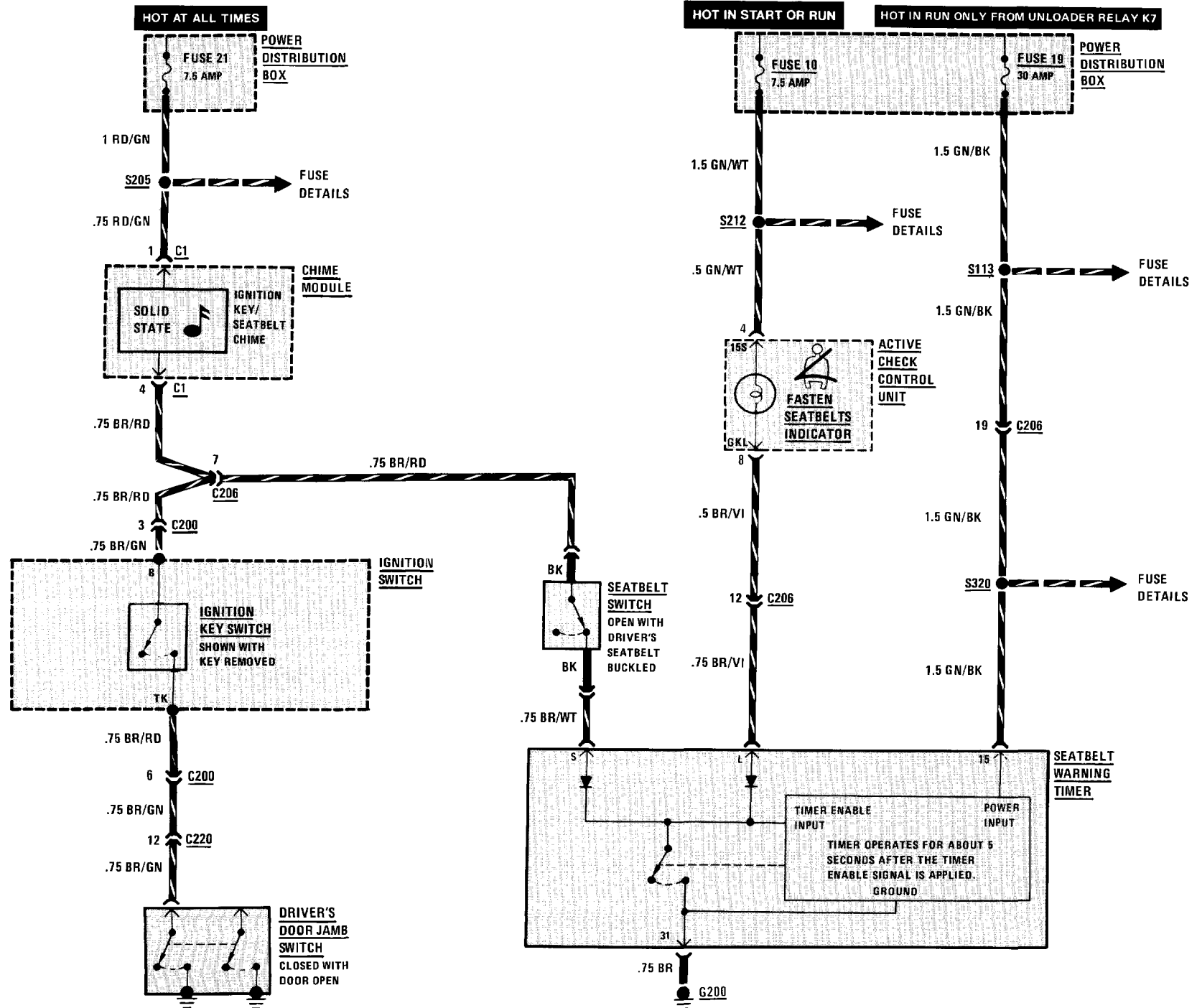



# 6160-0 WIPER/WASHER

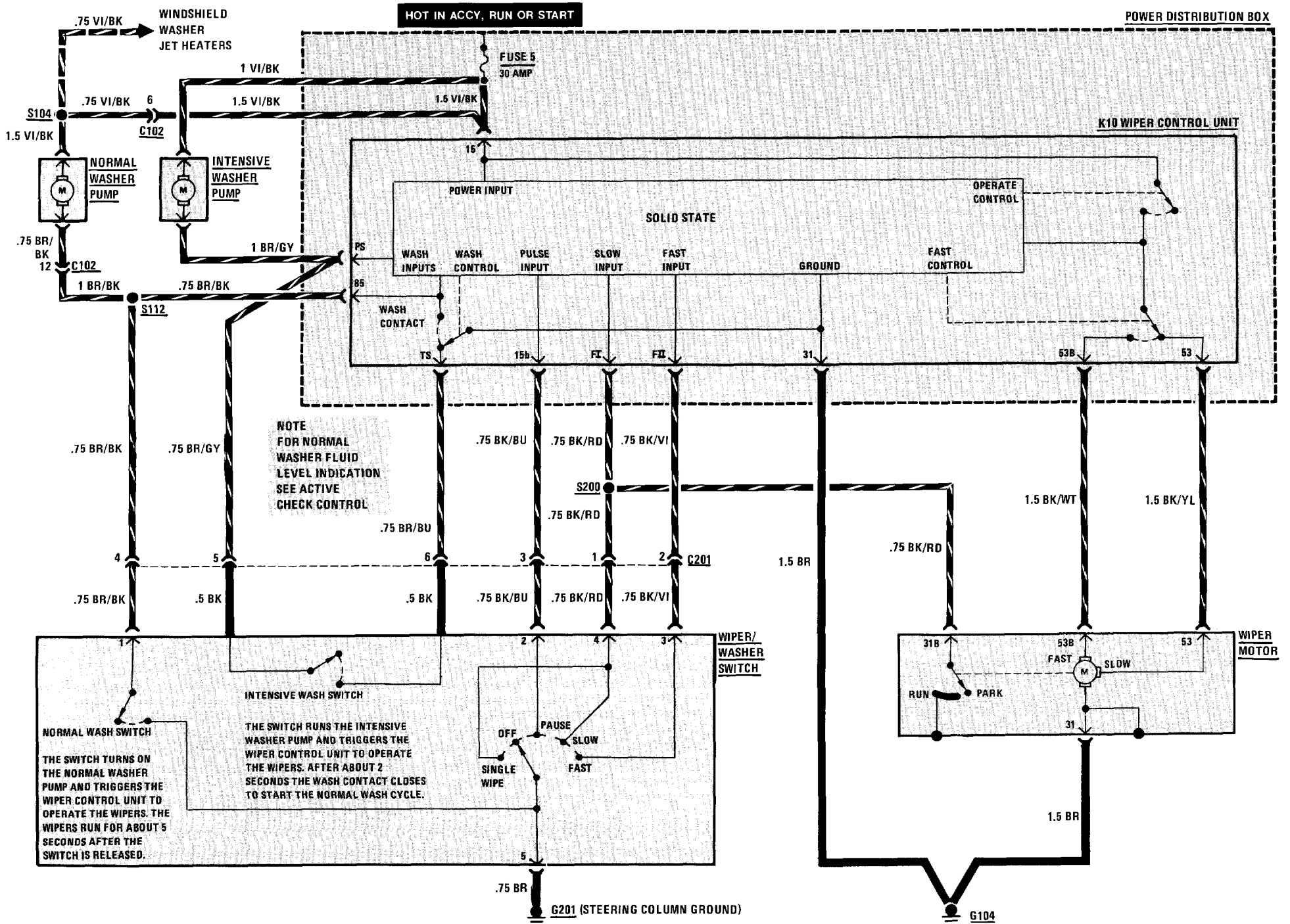

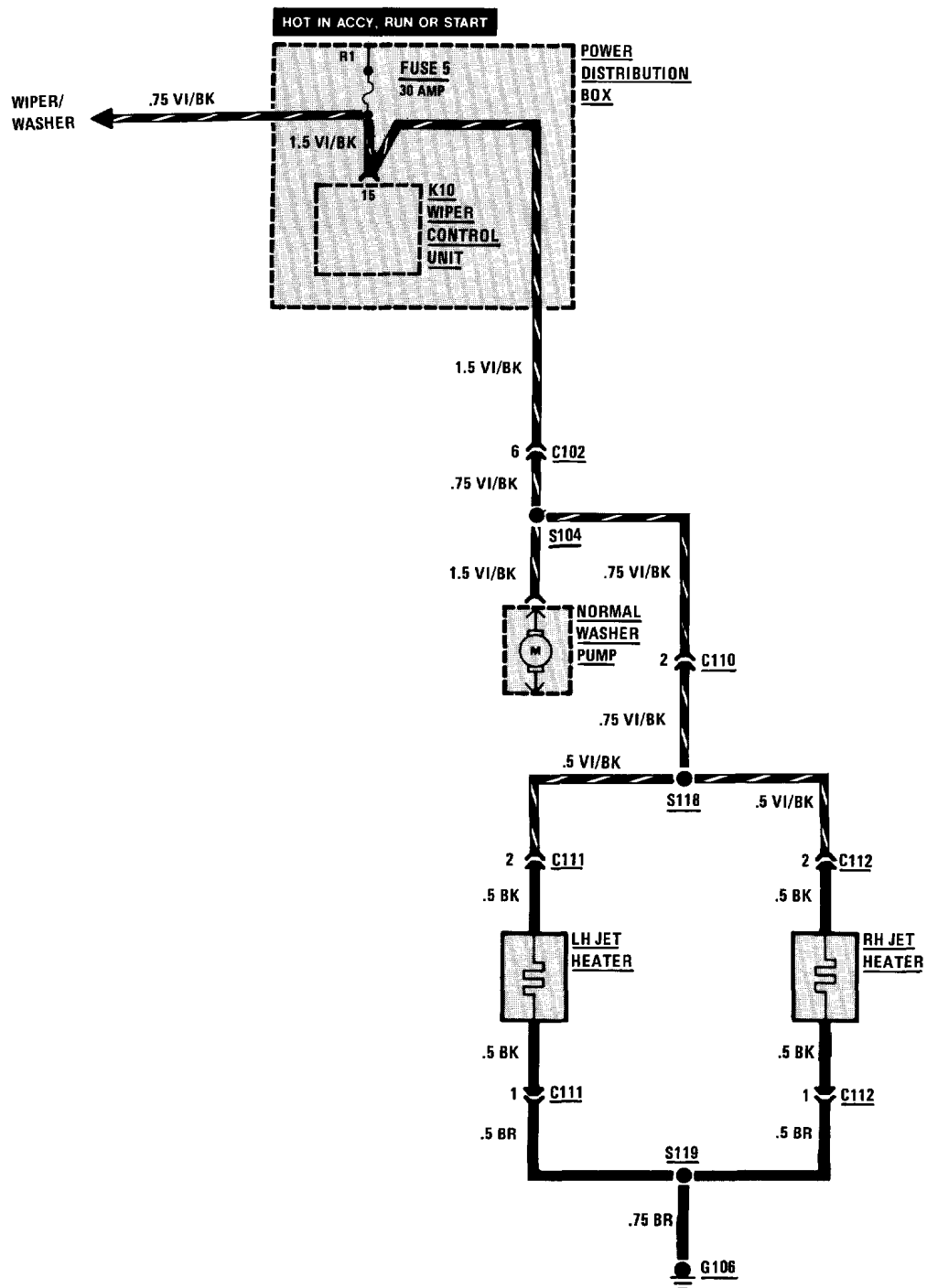

**SYSTEM CHECK TABLE**

ACTION	NORMAL OPERATION
Activate Single Wipe by moving the Wiper/Washer control arm down and then releasing it.	Wipers sweep once and park.
Activate Pause Wipe by moving the Wiper/Washer control arm up one position.	Wipers sweep at slow speed every 5 seconds.
Activate Slow Wipe by moving the Wiper/Washer control arm up one more position.	Wipers sweep at slow speed.
Activate Fast Wipe by moving the Wiper/Washer control arm up one more position.	Wipers sweep at fast speed.
Turn Wipers off by returning Wiper/Washer control arm to the original position.	Wipers stop and park.
Activate Normal Wash Cycle by pulling Wiper/Washer control arm towards driver.	Normal Washer Pump runs until control arm is released and Wipers sweep at slow speed. After control arm is released, wipers continue for 3 seconds.
Activate Intensive Wash by pushing Wiper/Washer control arm to the left.	Intensive Washer Pump runs for 1 second before a 2-second Normal Wash Cycle. Wipers sweep at slow speed for 5 seconds.

- Refer to System Diagnosis when a result is not normal.

**SYSTEM DIAGNOSIS**

- Do the tests listed for your symptom in the Symptom Table below.
- Tests follow the Symptom Table.

**SYMPTOM TABLE**

SYMPTOM	FOR DIAGNOSIS
Wipers do not operate at all.	Do Test A: K10 Wiper Control Unit Battery Voltage Test Do Test B: Wiper Motor Test Do Test C: Wiper/Washer Switch Test
Wipers do not operate in PAUSE.	Do Test C: Wiper/Washer Switch Test

(Continued on next page)

# 6160A-2 WIPER/WASHER

(Continued from previous page)

Wipers do not operate in SLOW or FAST.	Do Test B: Wiper Motor Test Do Test C: Wiper/Washer Switch Test
Normal Washer does not operate at all.	Do Test D: Normal Washer Pump Test
Wipers do not park.	Check 31B wire of Wiper Motor for an open. If wire is OK, replace Wiper Motor.
Wipers run continuously.	1. Disconnect connector C201. If Wipers stop, replace Wiper/Washer Switch. 2. Check that wires to terminals 3 and 4 are not shorted to ground. 3. Replace K10 Wiper Control Unit.
Washer Jets freeze.	Do Test E: Washer Jet Heater Test
Intensive Washer Pump does not operate at all.	Do Test F: Intensive Washer Pump Test

## A: K10 WIPER CONTROL UNIT BATTERY VOLTAGE TEST

<b>Measure: VOLTAGE</b> <b>At: K10 WIPER CONTROL UNIT</b> (Disconnected) <b>Condition:</b> • Ignition Switch: ACCY		
Measure Between	Correct Voltage	For Diagnosis
15 & Ground	Battery	See 1
15 & 31	Battery	See 2
• If both voltages are correct, go to Symptom Table. 1. Check Fuse 5 and wire to terminal 15 for an open. 2. Check wire from terminal 31 for an open to ground.		

## B: WIPER MOTOR TEST

<b>Connect: FUSED JUMPER</b> <b>At: K10 WIPER CONTROL UNIT</b> (Disconnected) <b>Condition:</b> • Ignition Switch: ACCY		
Jumper Between	Correct Result	For Diagnosis
15 & 53B	Wipers sweep at Fast speed	See 1
15 & 53	Wipers sweep at Slow speed	See 2
• If both results are correct, go to Symptom Table. 1. Check wires from terminal 53B for an open (see schematic). If wire is OK, replace Wiper Motor. 2. Check wire from terminal 53 for an open (see schematic). If wire is OK, replace Wiper Motor.		

## C: WIPER/WASHER SWITCH TEST

<b>Connect: TEST LAMP</b> <b>At: K10 WIPER CONTROL UNIT</b> (Disconnected) <b>Conditions:</b> • Ignition Switch: ACCY • Wiper/Washer Switch: SINGLE WIPE and then SLOW		
Connect Between	Correct Result	For Diagnosis
15 & FI	Test Lamp Lights	See 1
• Wiper/Washer Switch: PAUSE		
15 & 15b	Test Lamp Lights	See 2
• Wiper/Washer Switch: FAST		
15 & FII	Test Lamp Lights	See 3

(Continued on next page)

(Continued from previous page)

- If all results are correct, replace K10 Wiper Control Unit.
- 1. Check wire from terminal FI of the Control Unit and wire from terminal 5 of the Wiper/Washer Switch for an open to ground. If wire is OK, replace Wiper/Washer Switch.
- 2. Check wire from terminal 15b for an open to ground. If wire is OK, replace Wiper/Washer Switch.
- 3. Check wire from terminal FII for an open to ground. If wire is OK, replace Wiper/Washer Switch.

**D: NORMAL WASHER PUMP TEST**

**Measure: VOLTAGE**  
**At: NORMAL WASHER PUMP CONNECTOR (Disconnected)**

- Conditions:**
- Ignition Switch: ACCY
  - Wiper/Washer Switch: WASH

Measure Between	Correct Voltage	For Diagnosis
Power Lead & Ground (see schematic)	Battery	See 1
Power Lead & Ground Lead (see schematic)	Battery	See 2

- If both voltages are correct, replace Normal Washer Pump.
- 1. Check power lead and Fuse 5 for an open (see schematic).
- 2. Check ground lead for an open to ground (see schematic). If OK, replace Wiper/Washer Switch.

**E: WASHER JET HEATER TEST**

**Connect: TEST LAMP**  
**At: EITHER JET HEATER CONNECTOR C111 OR C112 (Disconnected)**

- Condition:**
- Ignition Switch: ACCY

Connect Between	Correct Result	For Diagnosis
2 (Female) & Ground	Test Lamp Lights	See 1
2 (Female) & 1 (Female)	Test Lamp Lights	See 2

- If both results are correct, replace the defective Jet Heater.
- 1. Check Fuse 5 and wire to terminal 2 for an open.
- 2. Check wire from terminal 1 for an open and make sure ground G106 is clean and tight.

**F: INTENSIVE WASHER PUMP TEST (TABLE 1)**

**Measure: VOLTAGE**  
**At: INTENSIVE WASHER PUMP CONNECTOR (Disconnected)**

**Conditions:**

- Ignition Switch: ACCY
- Disconnect C201 & Jumper Terminal 5 To Ground

Measure Between	Correct Voltage	For Diagnosis
Power Lead & Ground (see schematic)	Battery	See 1

(Continued in next column)

(Continued from previous column)

Power Lead & Ground Lead (see schematic)	Battery	See 2
<ul style="list-style-type: none"> <li>• If both voltages are correct, go to Table 2.</li> <li>1. Check Fuse 5 and power lead for an open.</li> <li>2. Check ground lead for an open.</li> </ul>		

**F: INTENSIVE WASHER PUMP TEST (TABLE 2)**

**Connect: TEST LAMP**  
**At: K10 WIPER CONTROL UNIT (Disconnected)**

- Conditions:**
- Ignition Switch: ACCY
  - Wiper/Washer Switch: INTENSIVE WASH

Connect Between	Correct Voltage	For Diagnosis
TS & Ground	Test Lamp Lights	See 1

- If the result is correct, replace Wiper Control Unit.
- 1. Check wire to connector C201, terminal 6 for an open. If wire is OK, replace Wiper/Washer Switch.

# 6210-0 INSTRUMENT CLUSTER L6

## SPEEDOMETER/GAUGES/WARNING INDICATORS

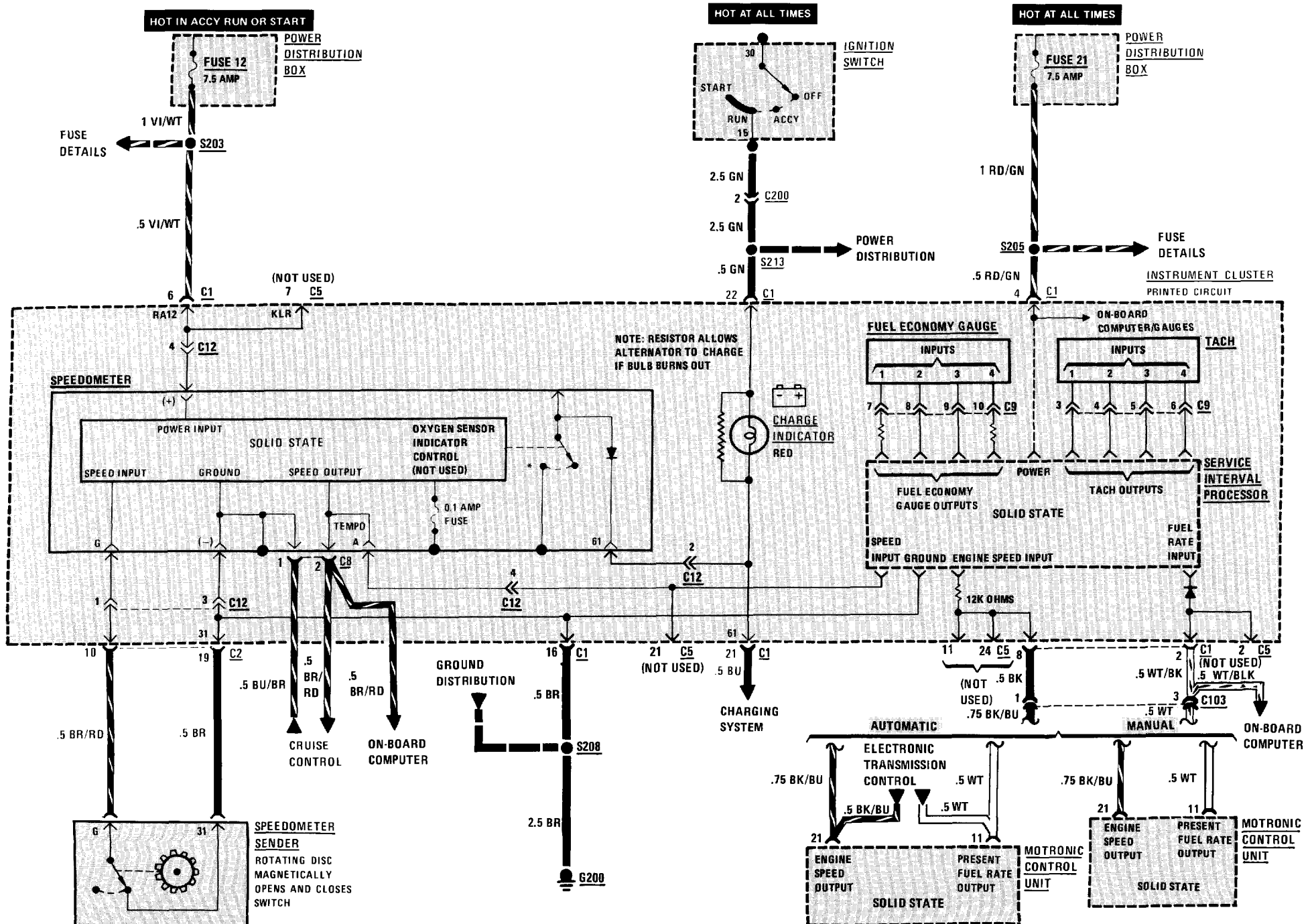

SPEEDOMETER/GAUGES/WARNING INDICATORS

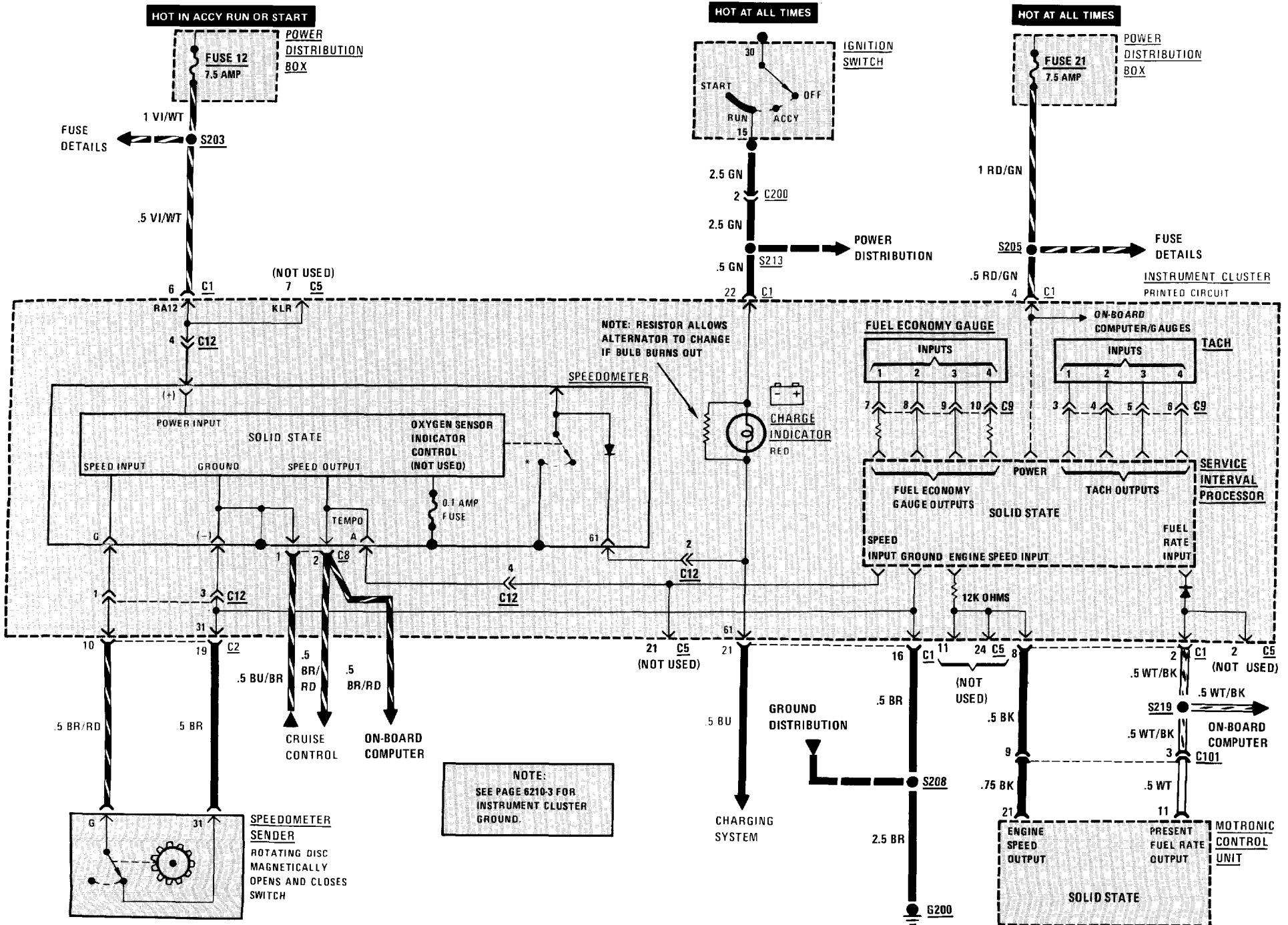

# 6210-2 INSTRUMENT CLUSTER

## GAUGES/WARNING INDICATORS

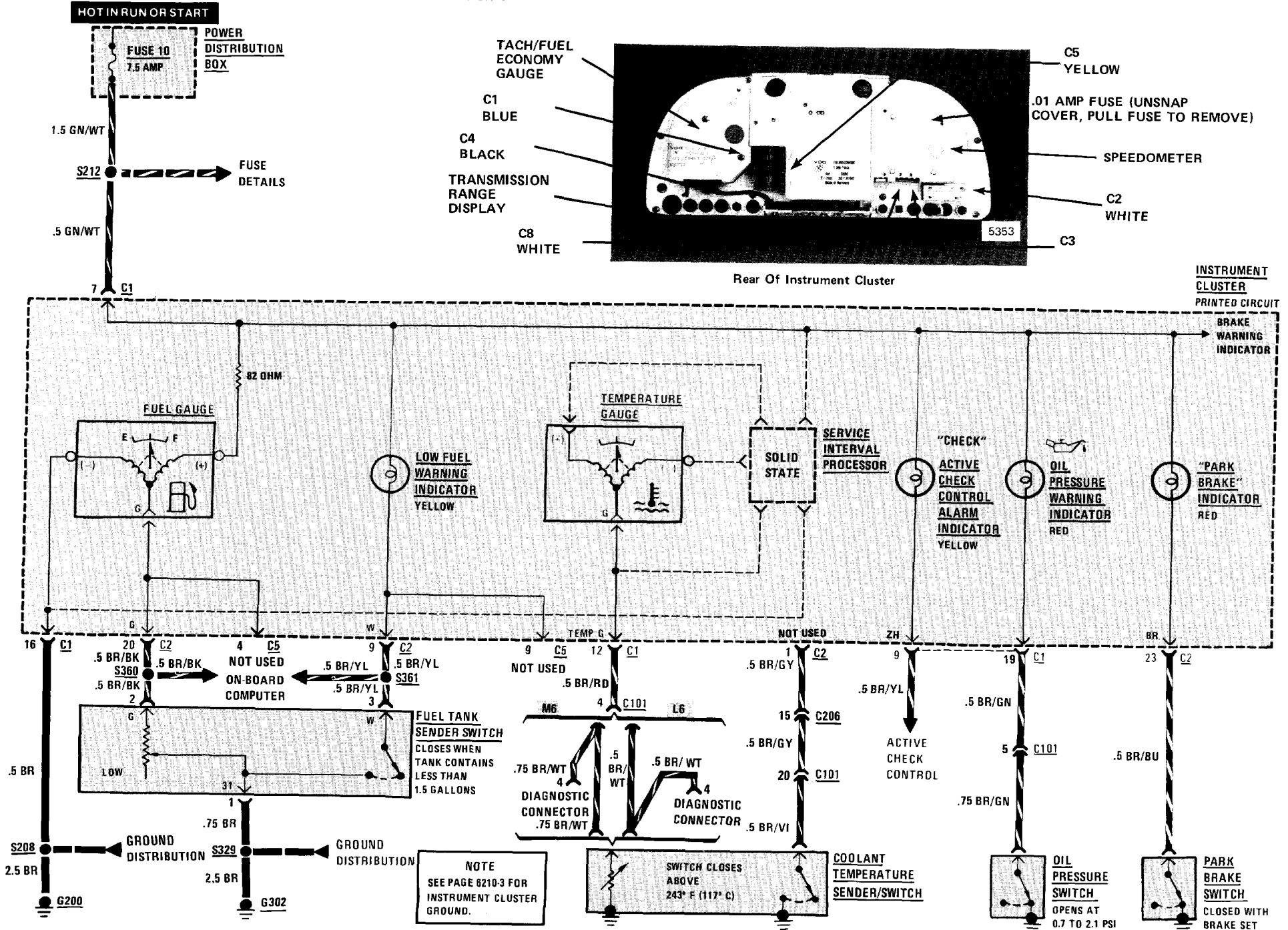



WARNING INDICATORS

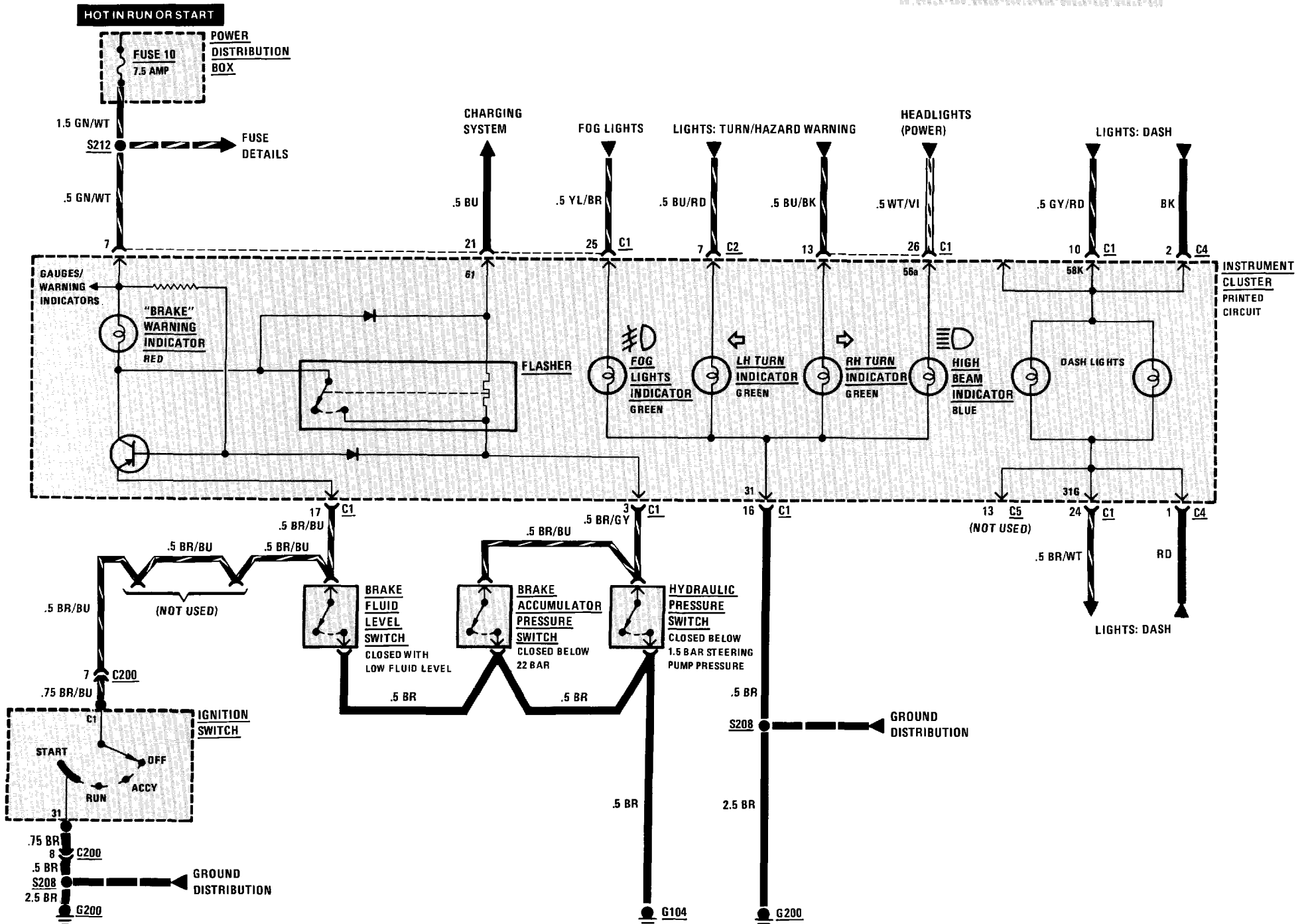

# 6210-4 INSTRUMENT CLUSTER

## SERVICE INTERVAL INDICATOR

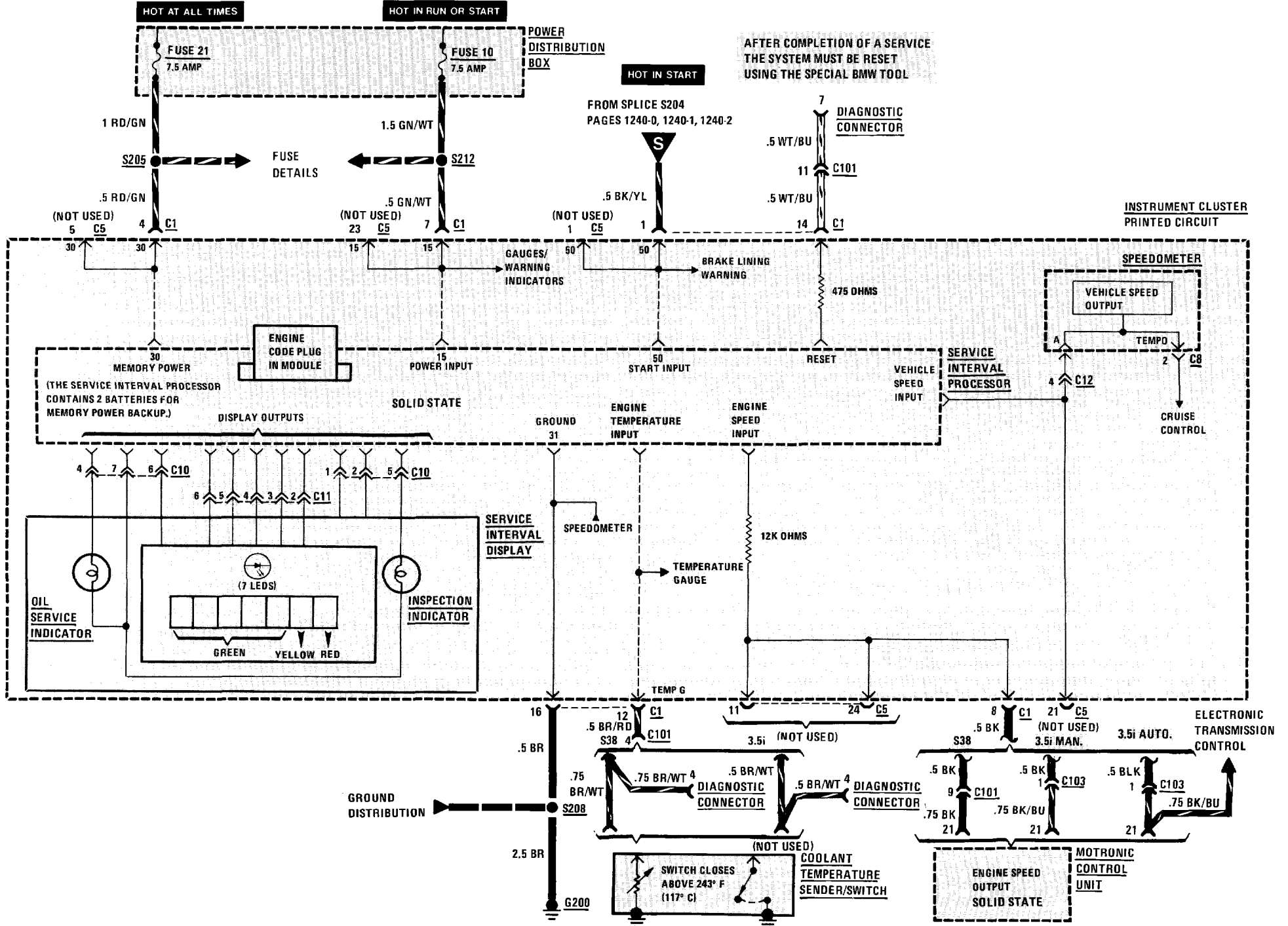

**ACTIVE CHECK CONTROL**

1. When the Ignition Switch is initially placed in "Run," the Active Check Control Arm Indicator flashes, and the Active Check Control Unit Brake Light LED and panel light illuminate for test purposes. Depressing the brake pedal clears the display.
2. When the Ignition Switch is placed in "Run," fault monitoring begins. To monitor the low beams, rear lights, or license lights, those circuits must be on. The brake lights are monitored only while the brake pedal is depressed.
3. When a fault occurs, the alarm indicator flashes, the appropriate LED fault indicator lights, and the panel light goes on for five seconds. Depressing the test button will clear the alarm indicator, but the LED fault indicator remains on.

4. To test the unit, depress the test button. The LED fault indicators and the panel lights should go on.

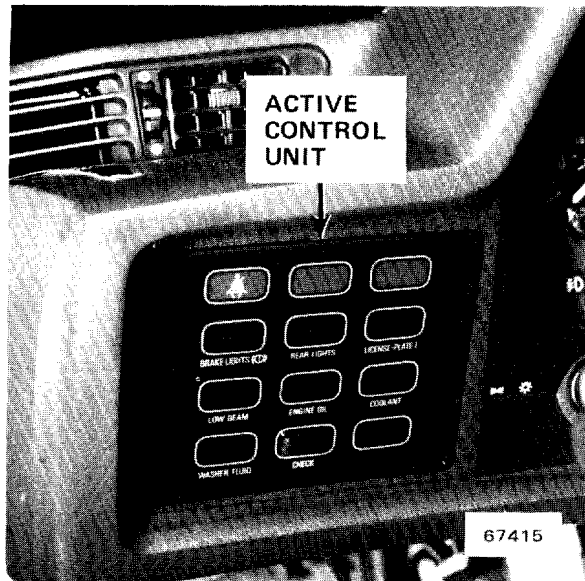
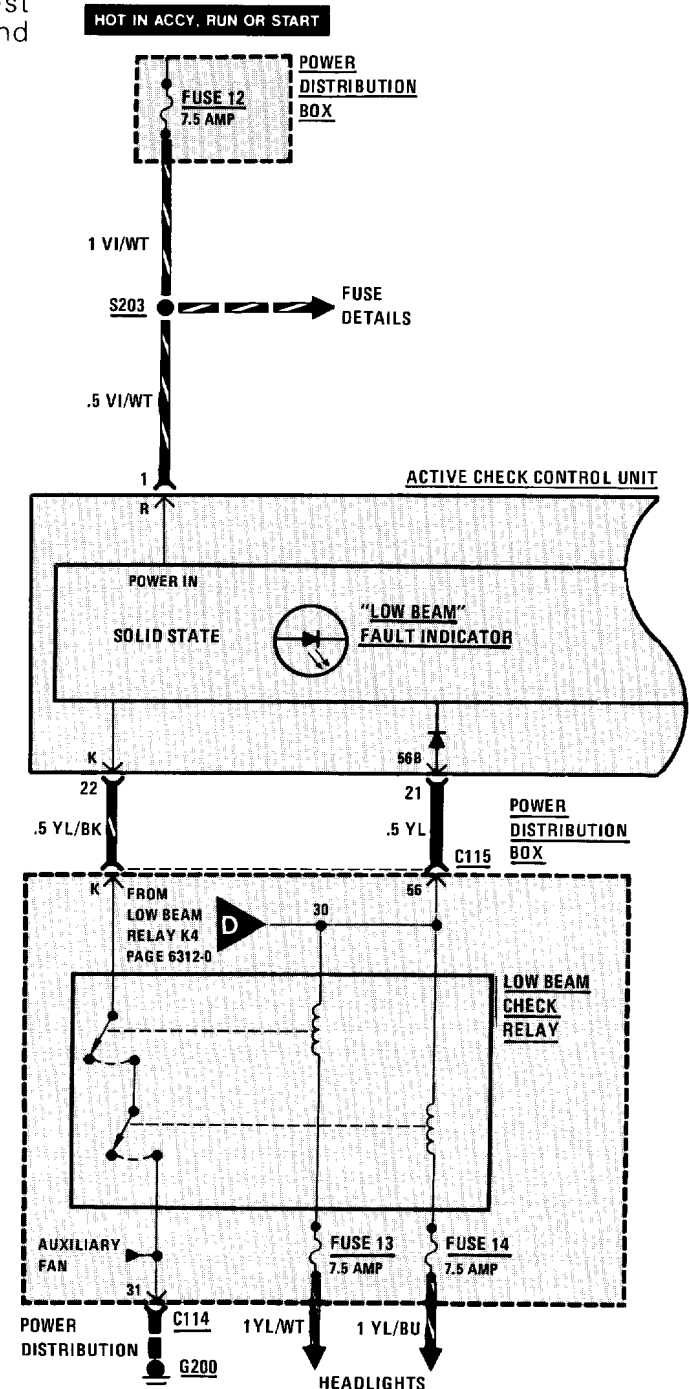
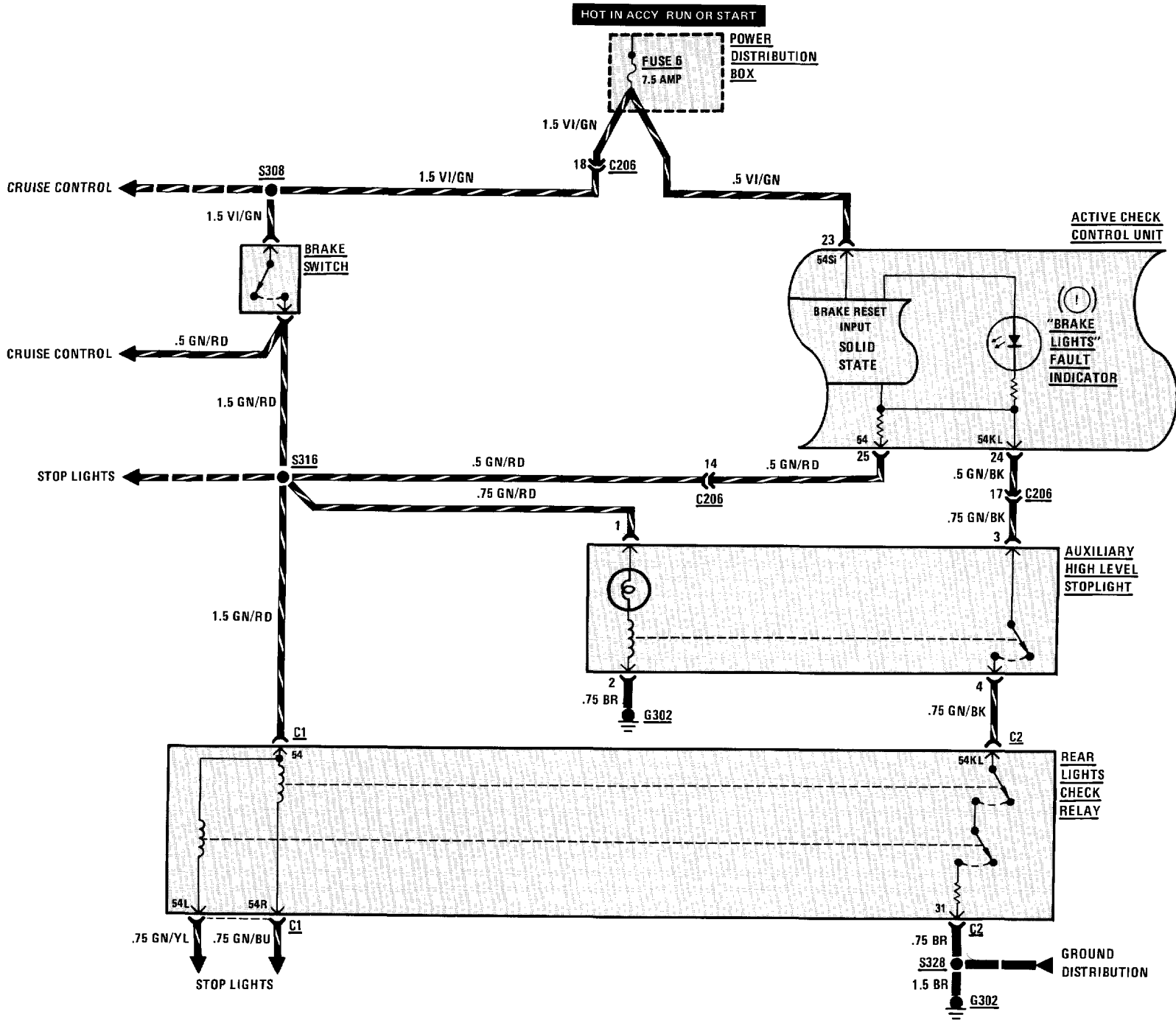
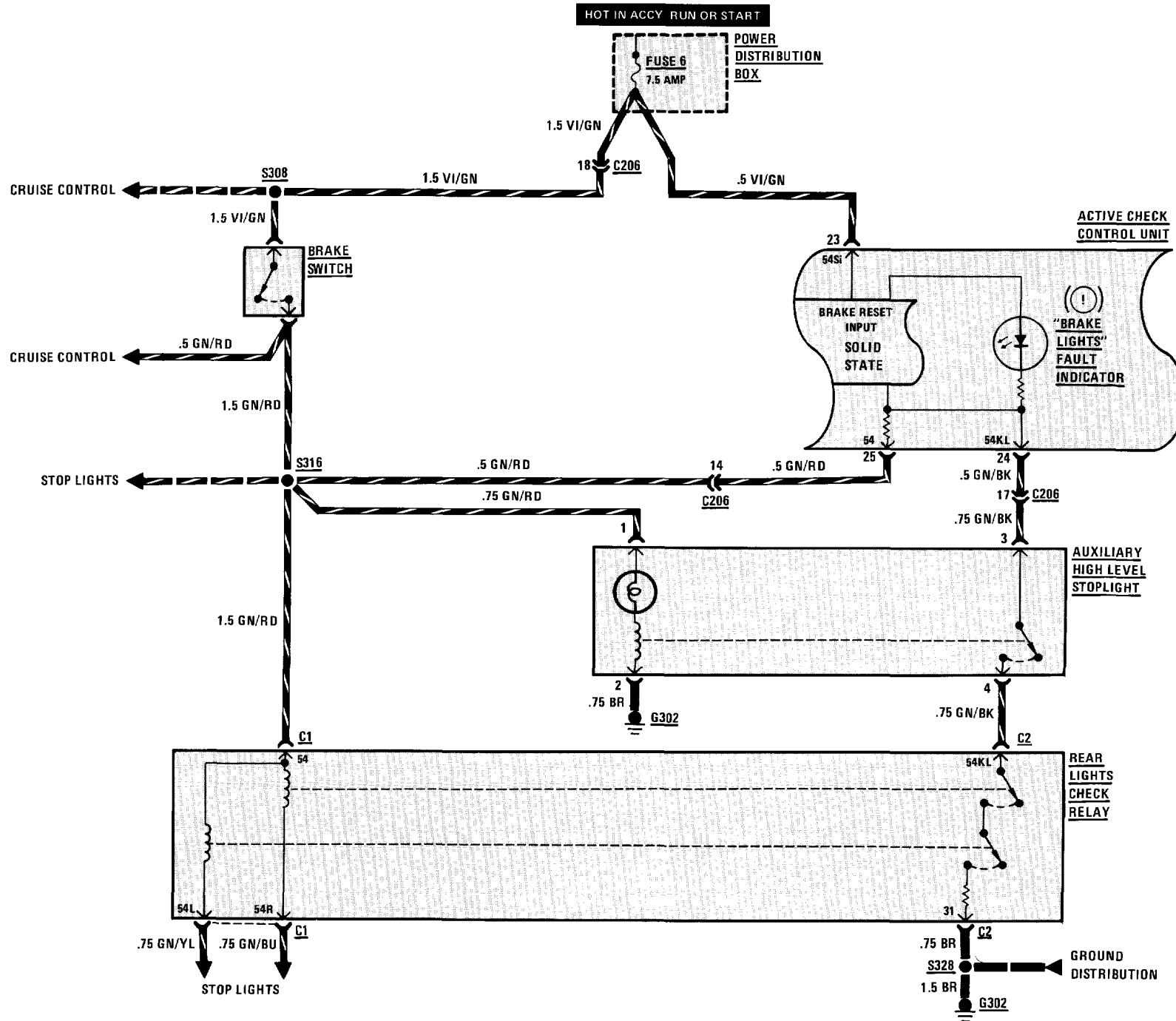
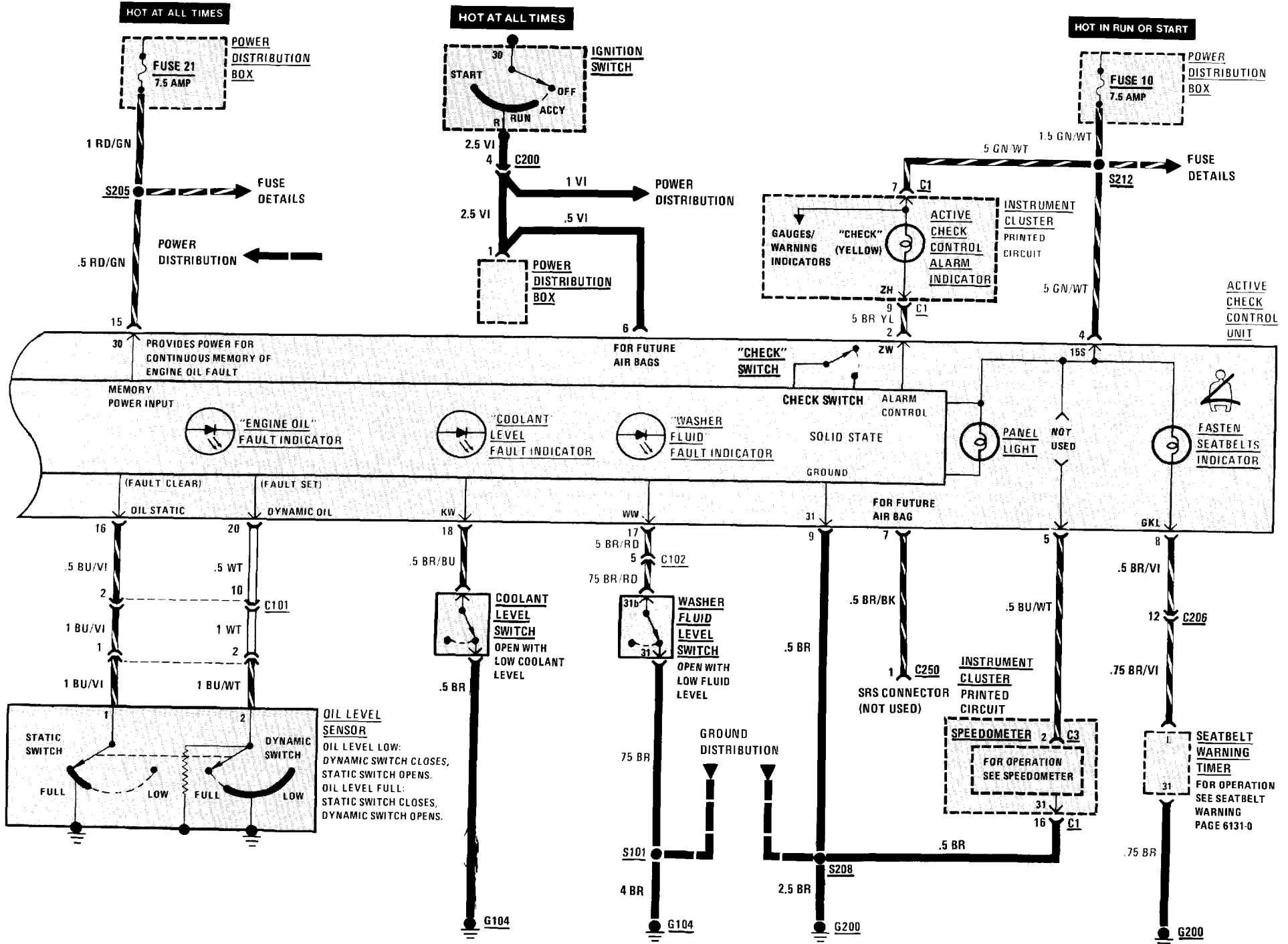

Figure 1 - Active Check Control Unit (Dash, Left Of Steering Column)









LIGHTS: DASH/TRANSMISSION RANGE/RH VISOR

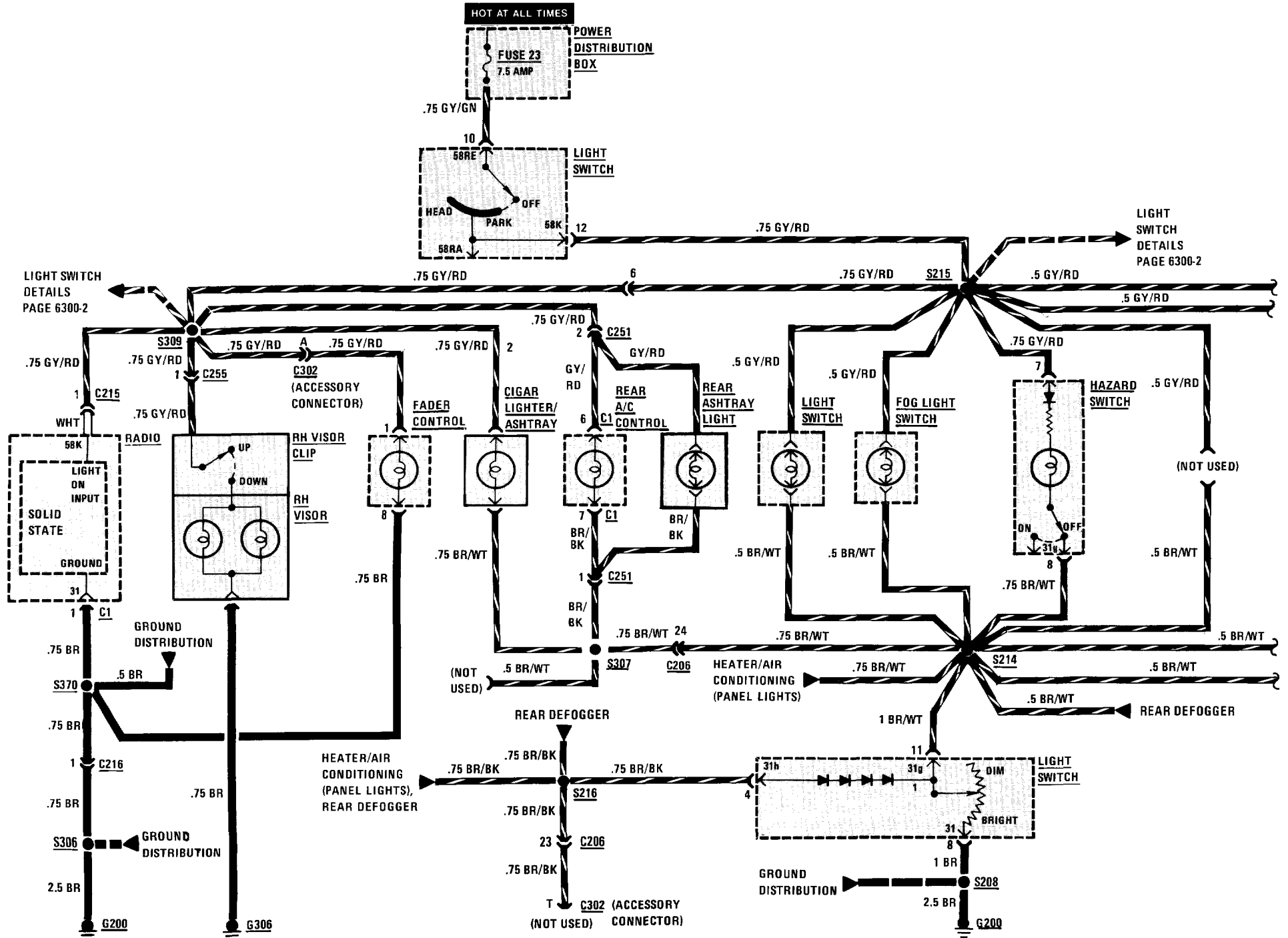

LIGHTS: DASH/TRANSMISSION RANGE

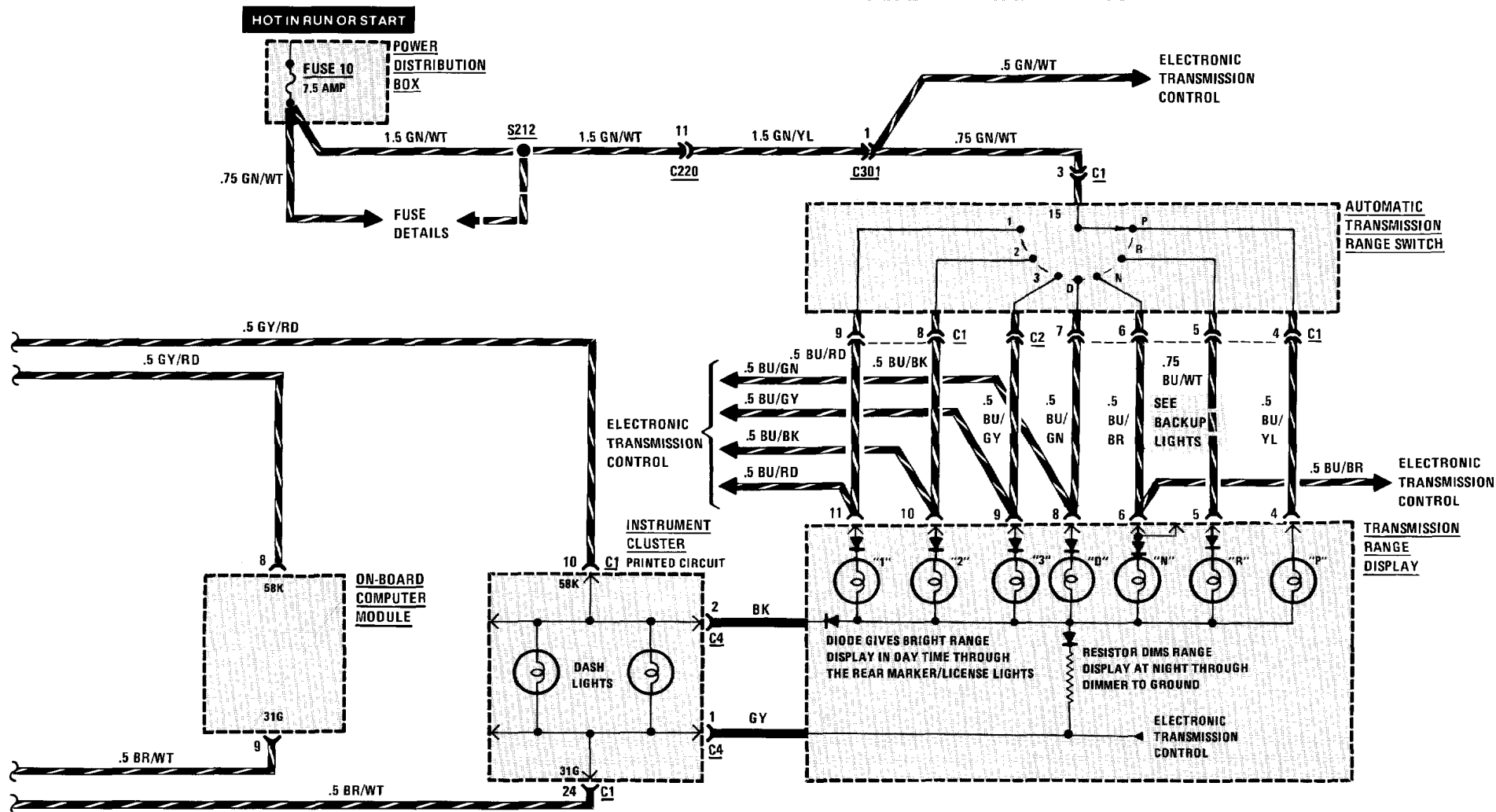



# 6300-2 LIGHT SWITCH DETAILS

HOT AT ALL TIMES

NOTE: LIGHT SWITCH DETAILS FOR HEADLIGHTS AND FOG LIGHTS SEE PAGE 6312-0

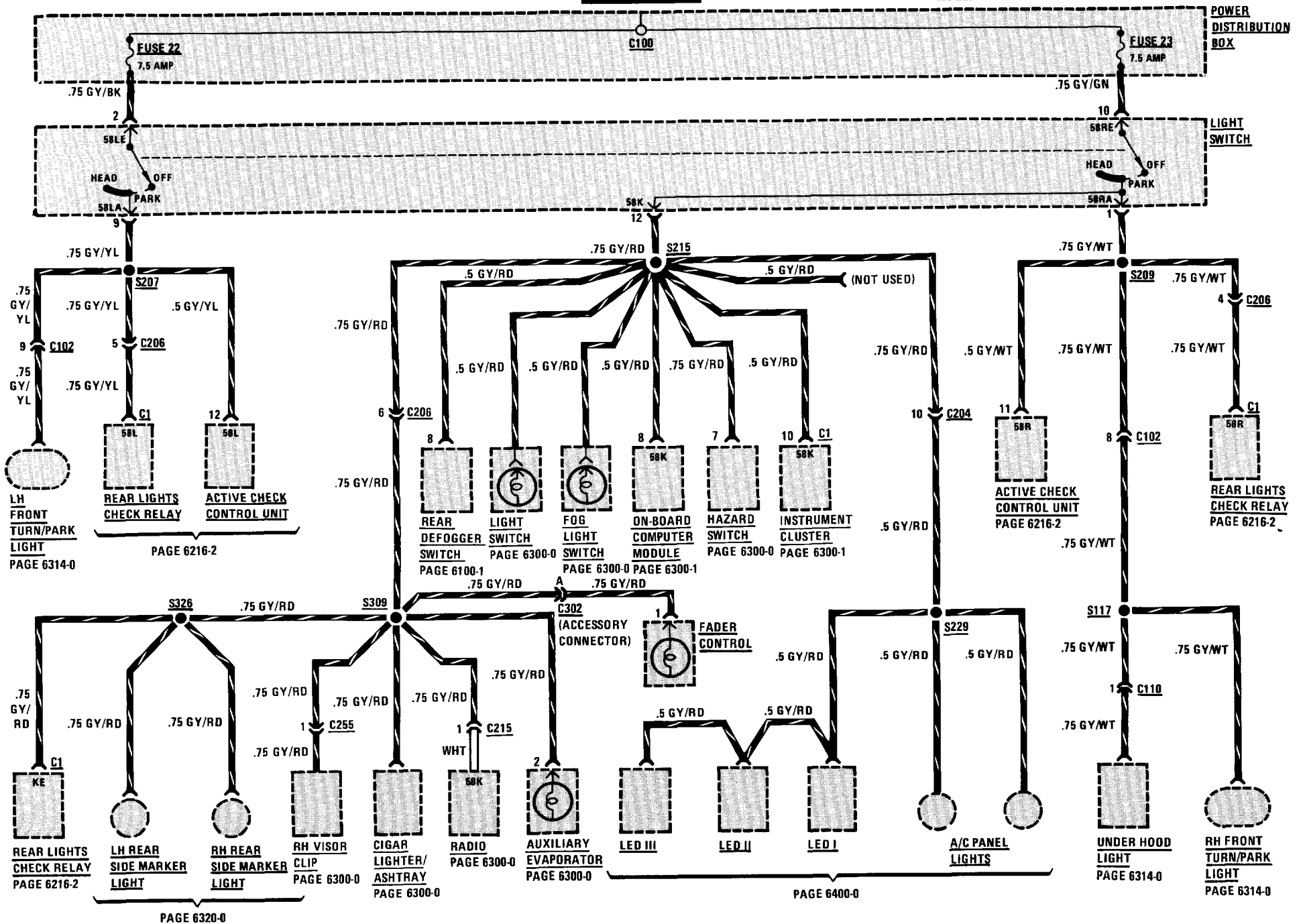

# 6312-0 HEADLIGHTS/FOG LIGHTS

## HEADLIGHTS (CONTROL) AND FOG LIGHTS

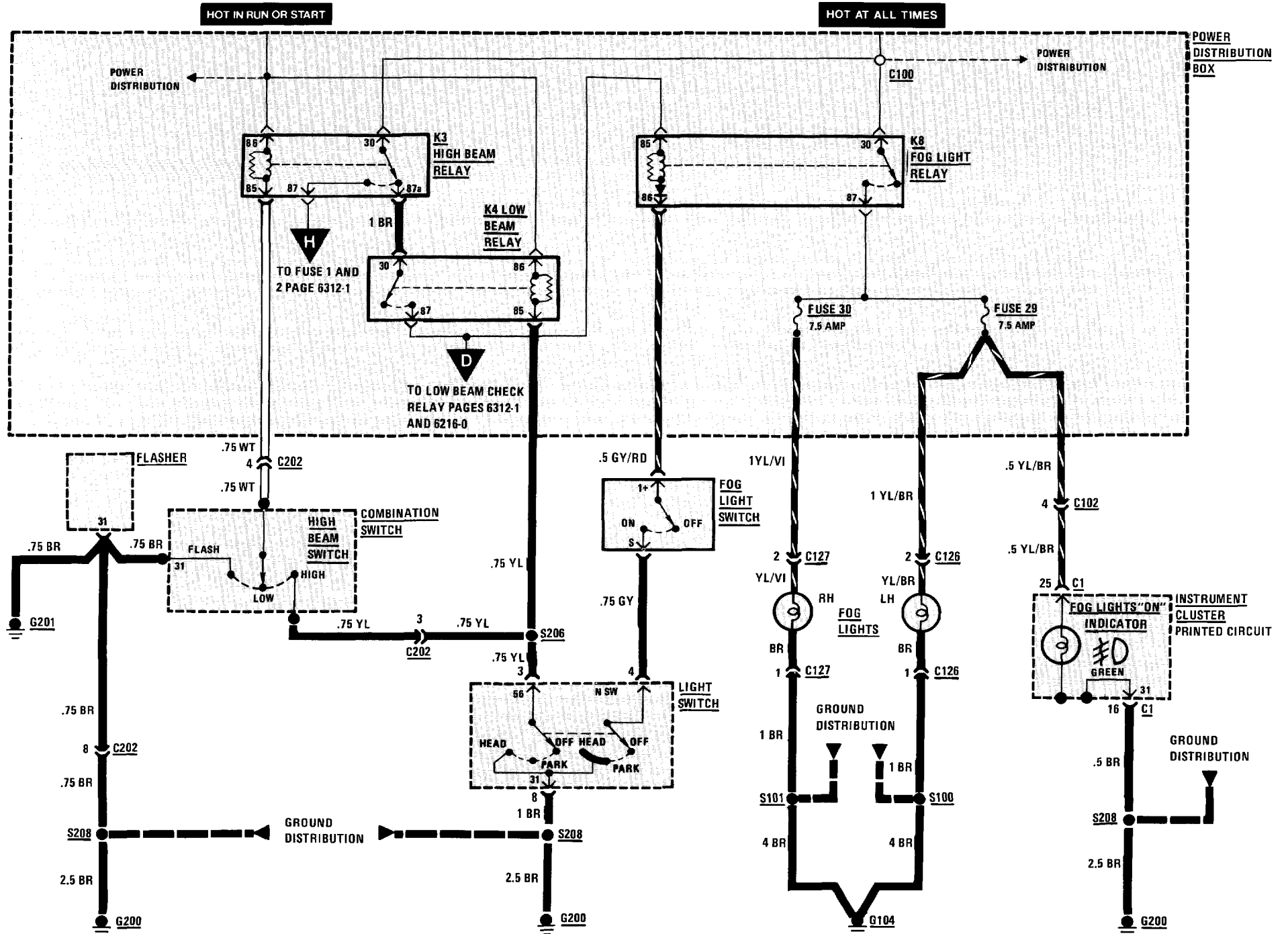

HEADLIGHTS (POWER)

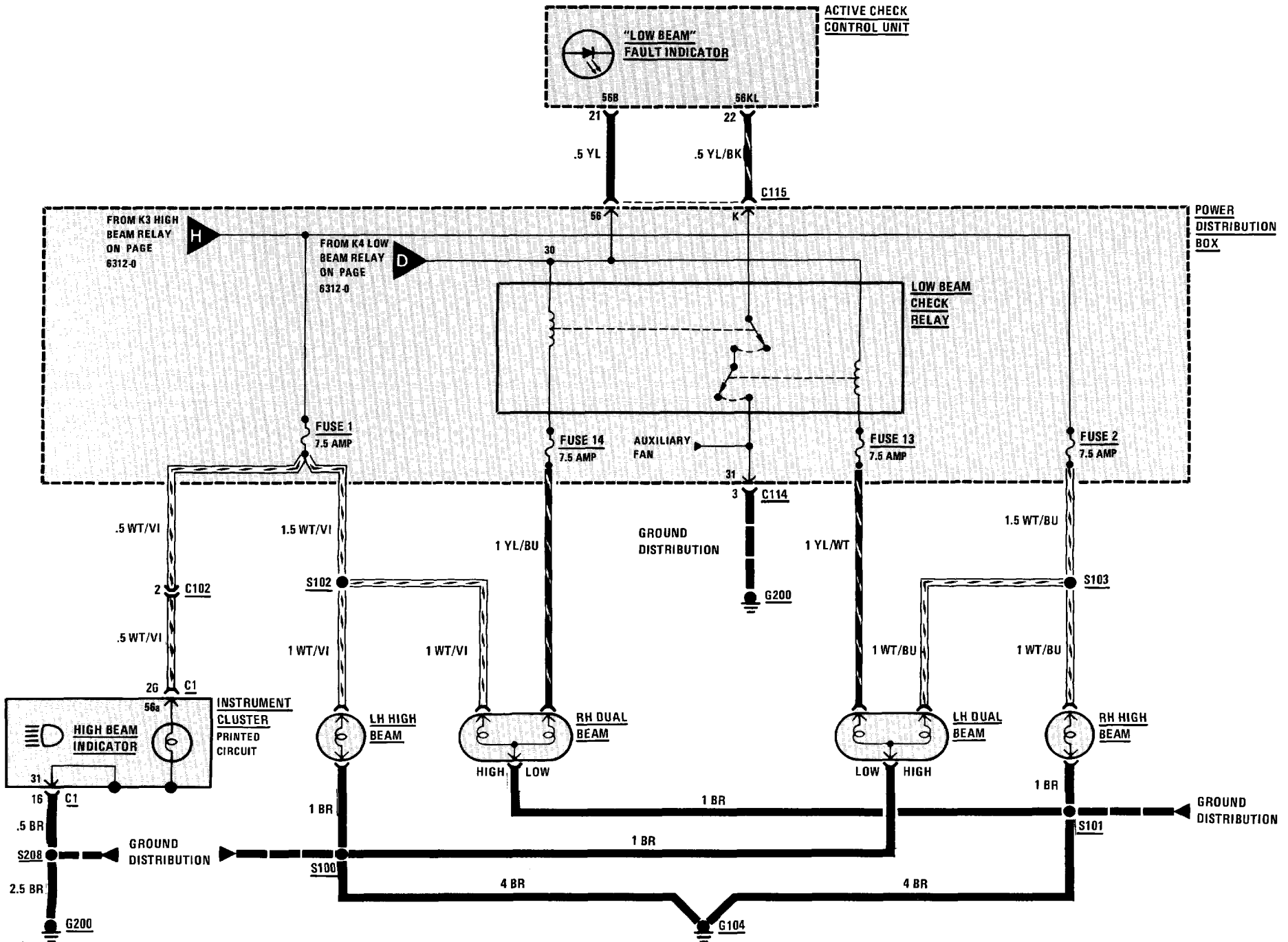

# 6313-0 TURN/HAZARD LIGHTS

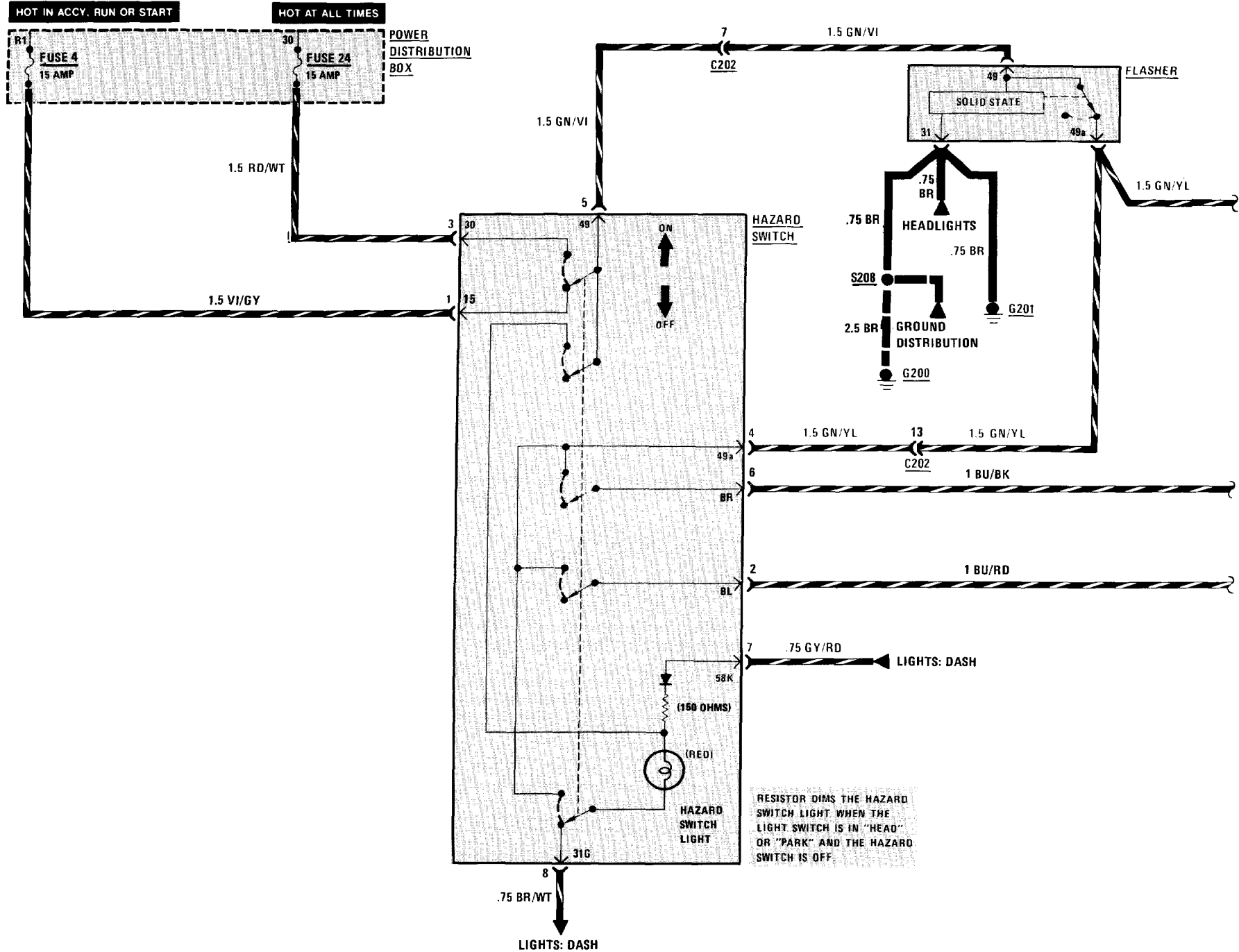

# TURN/HAZARD LIGHTS 6313-1

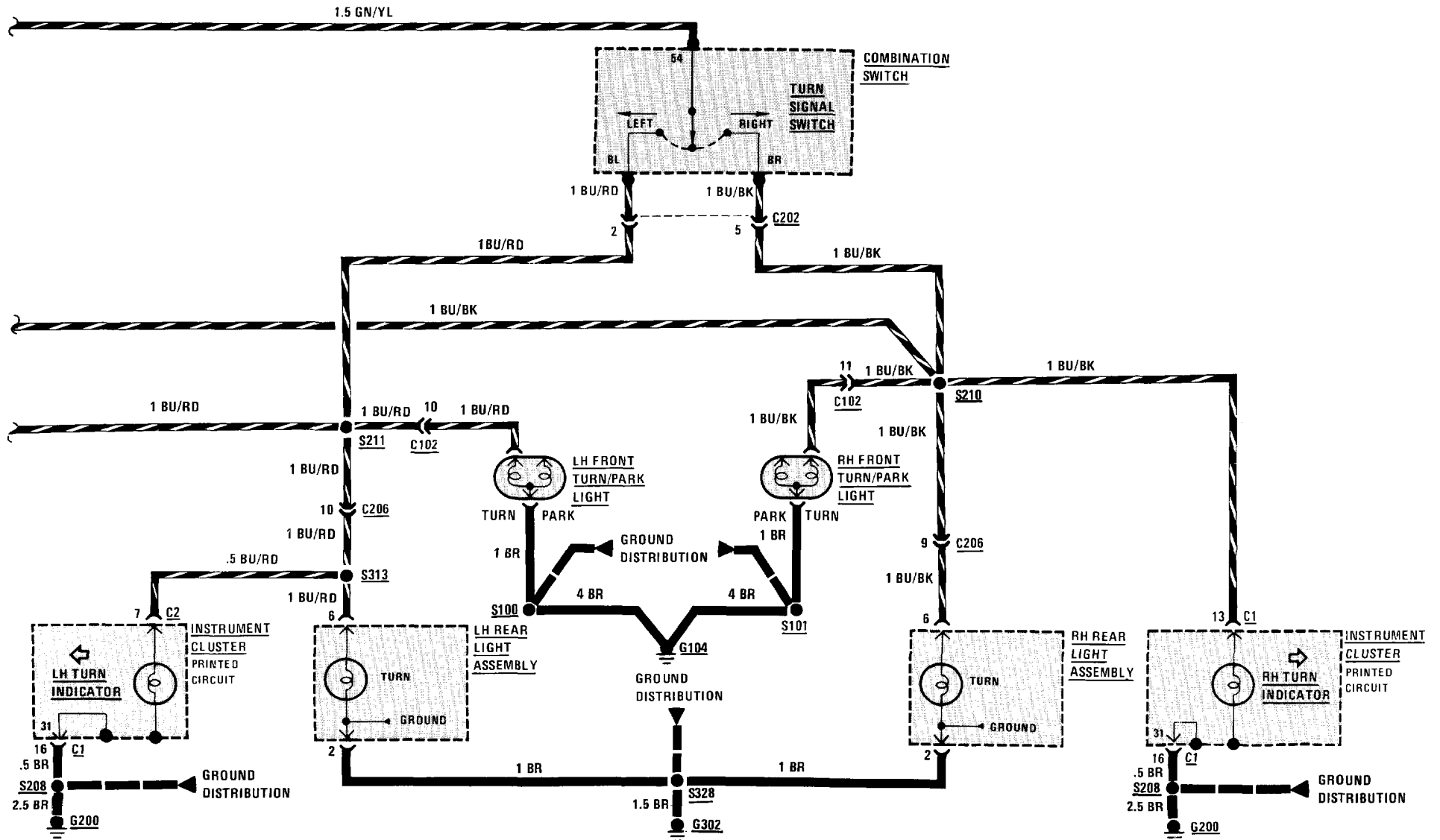

# 6314-0 PARK/TAIL/UNDERHOOD LIGHTS

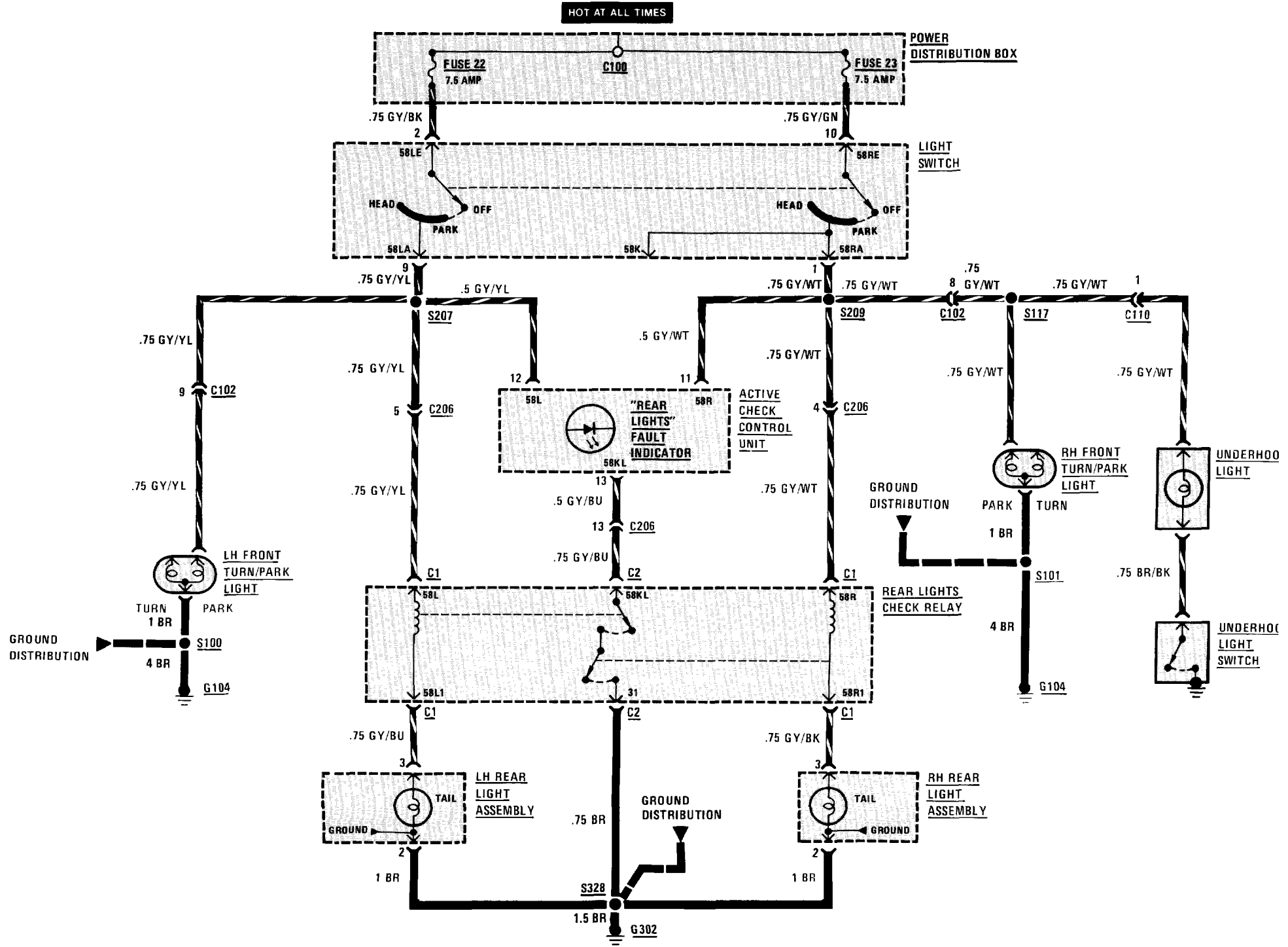

# 6320-0 REAR MARKER/LICENSE/TRUNK LIGHTS

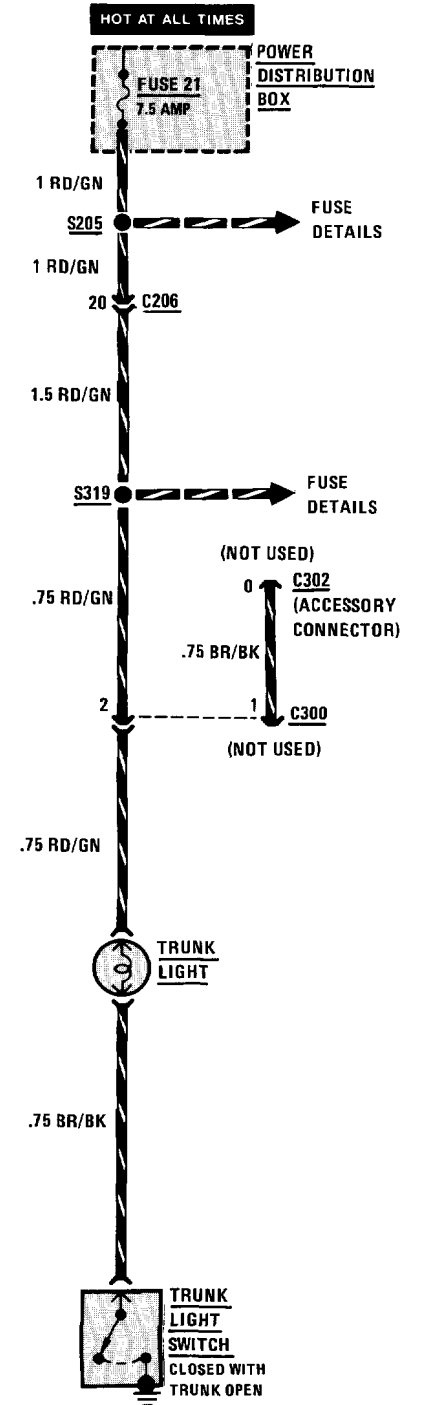
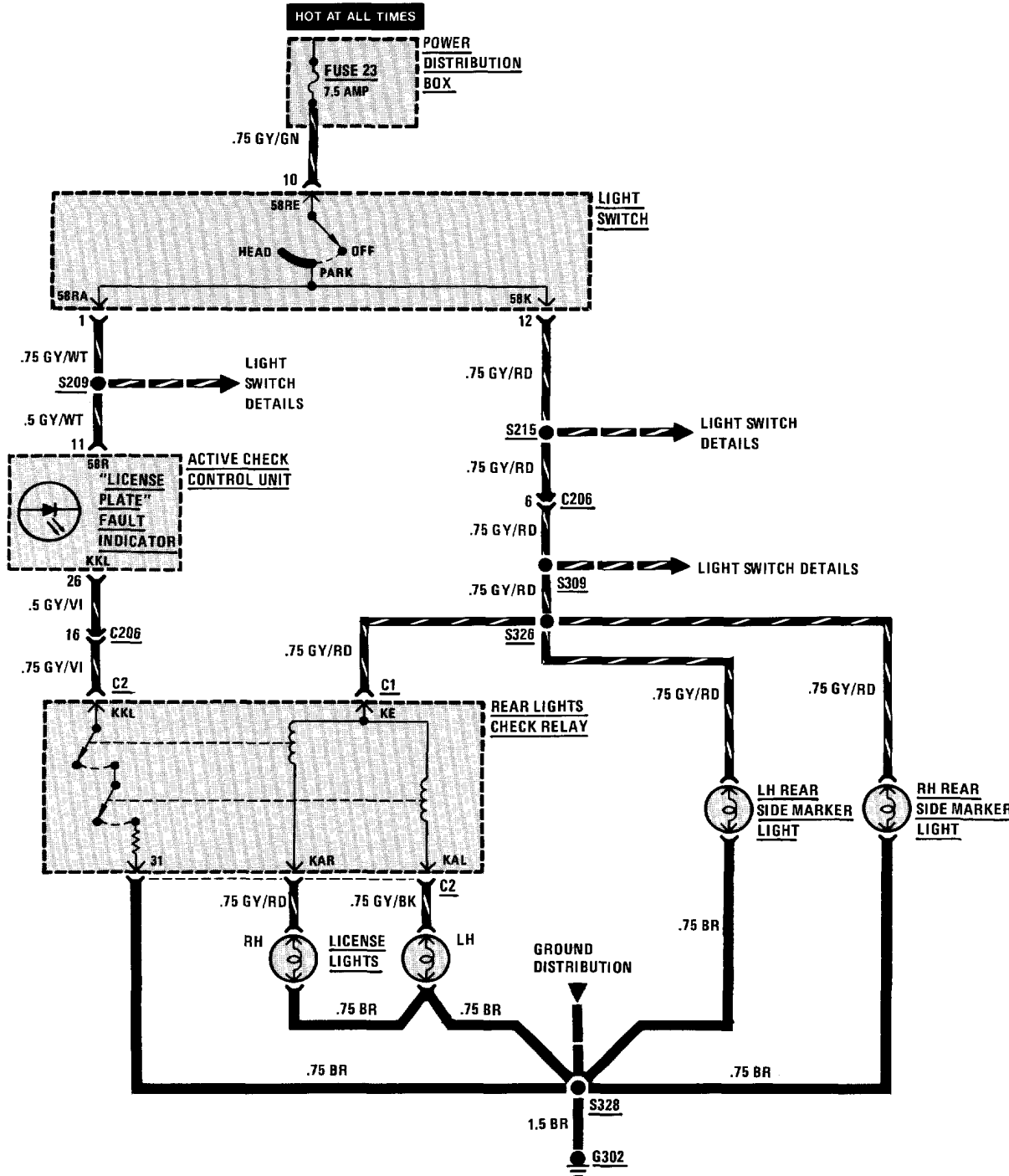

# 6322-0 BACKUP LIGHTS

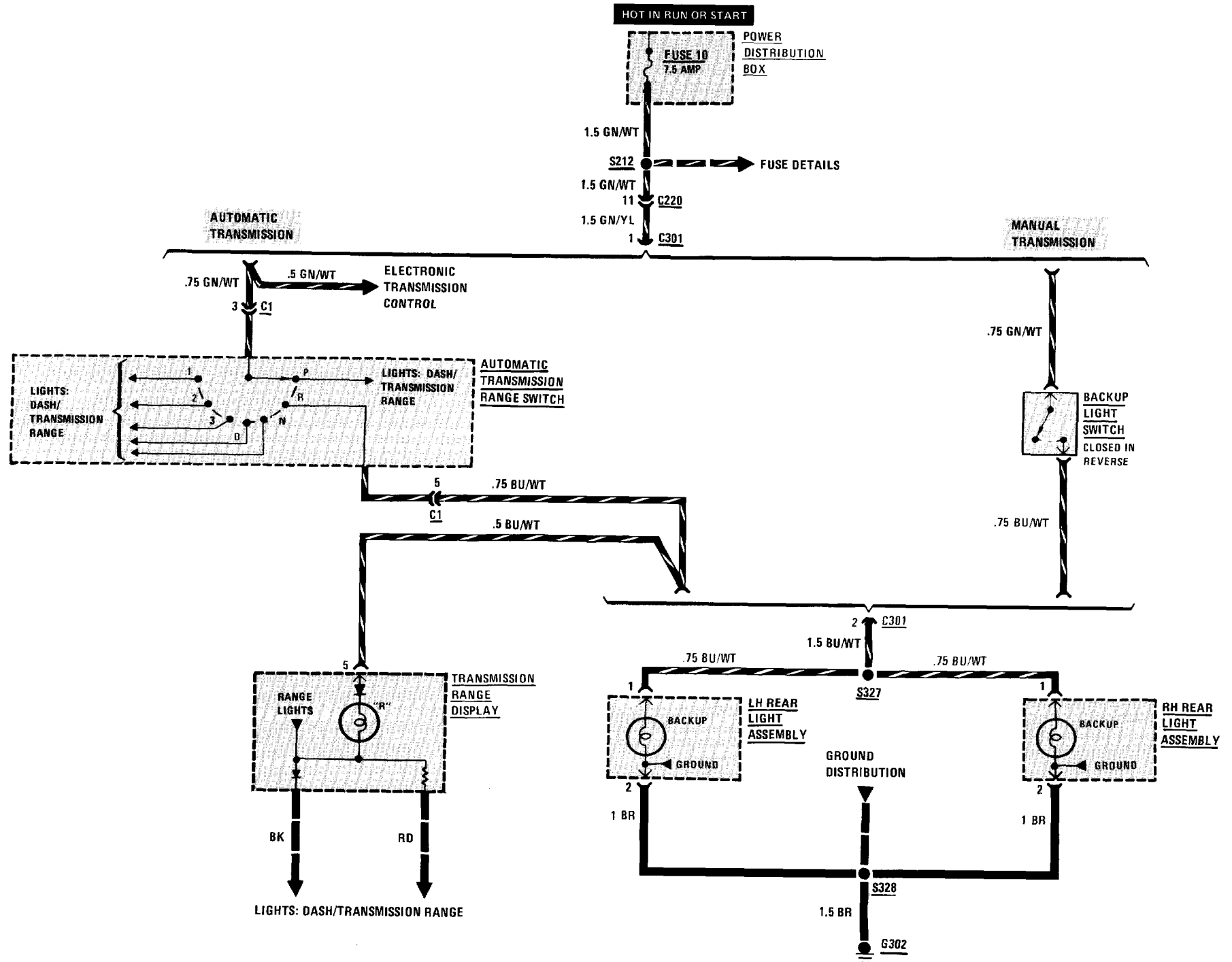



# 6325-0 STOP LIGHTS

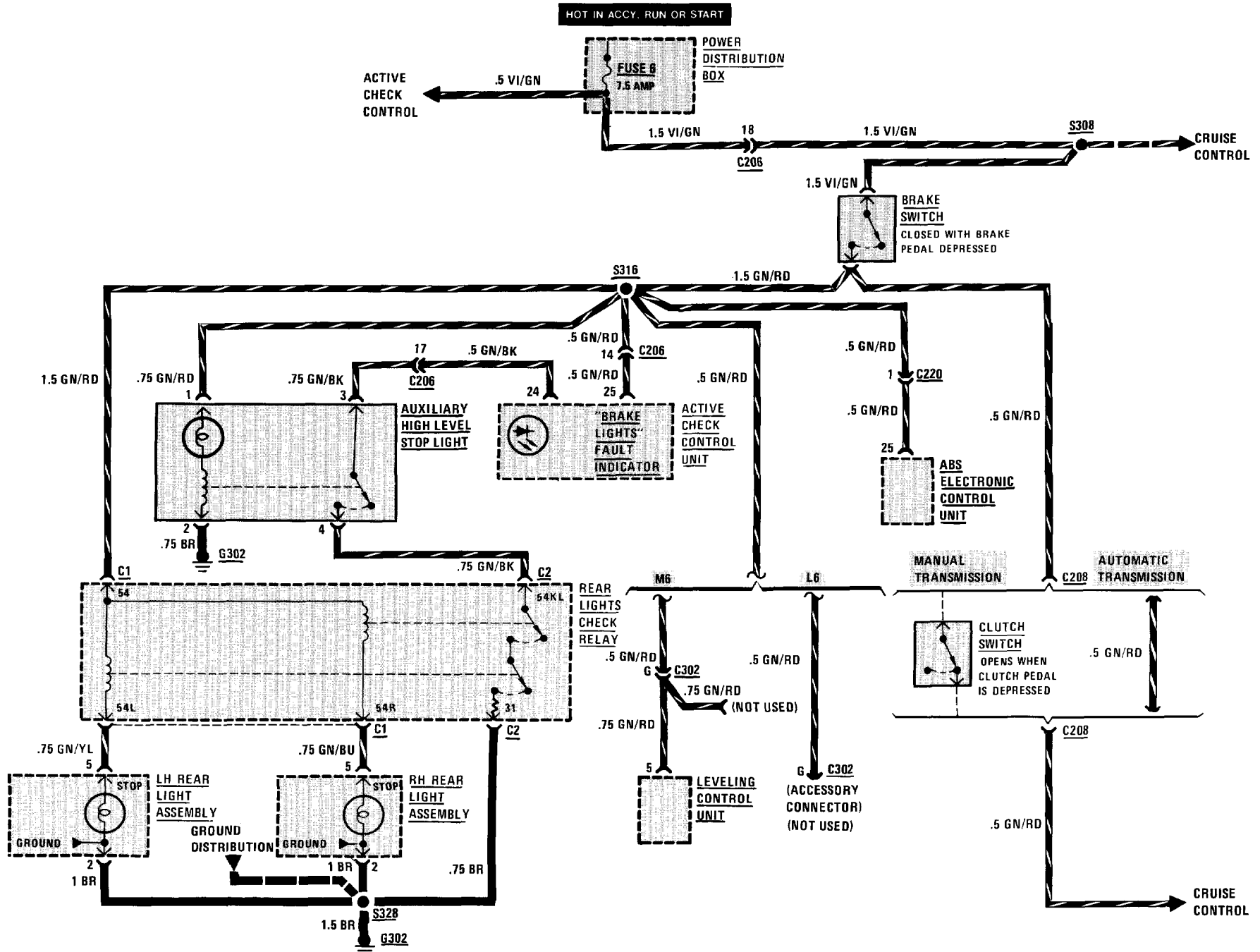

# 6330-0 INTERIOR LIGHTS

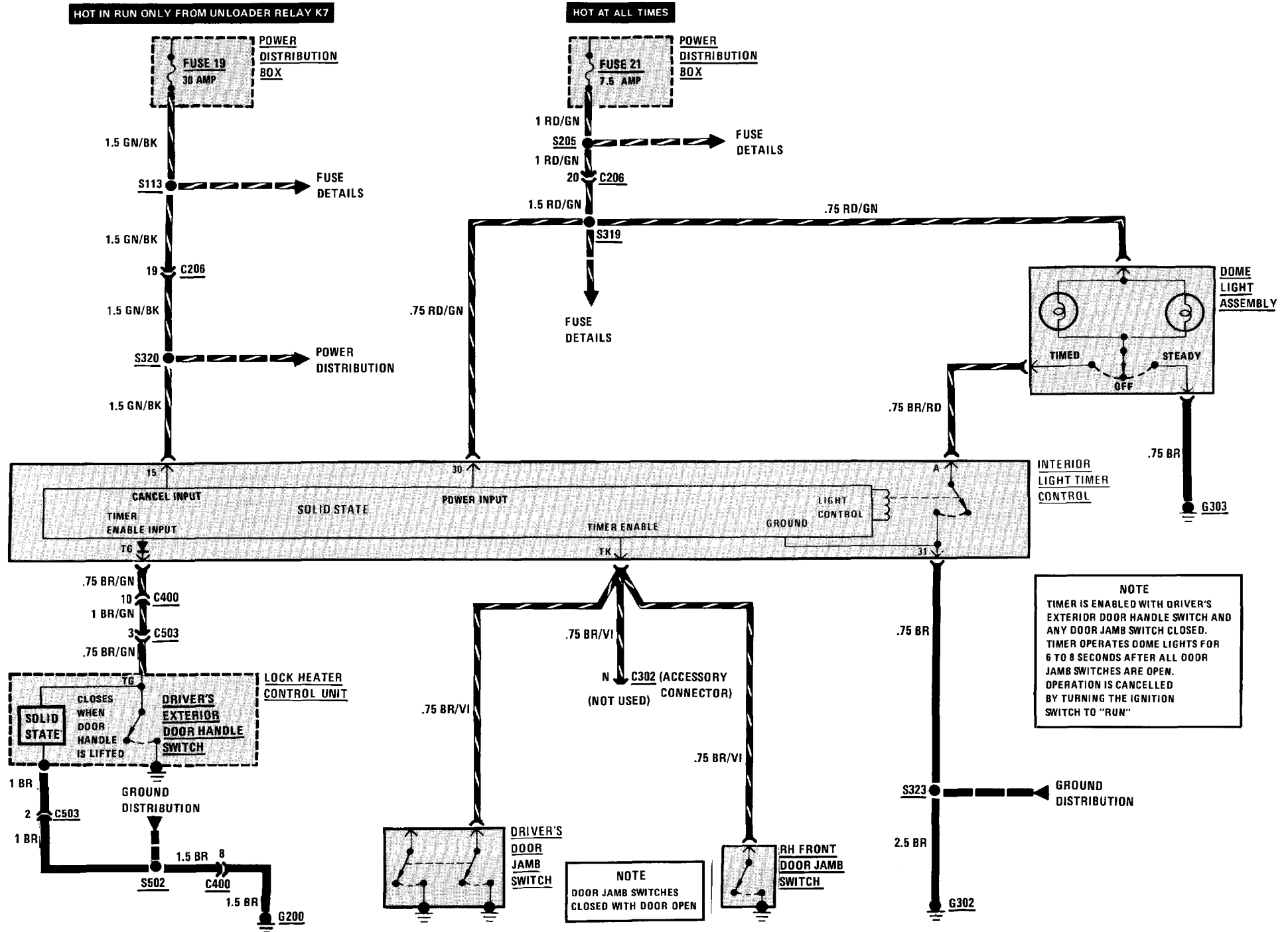

HEATING AND A/C PANEL LIGHTS

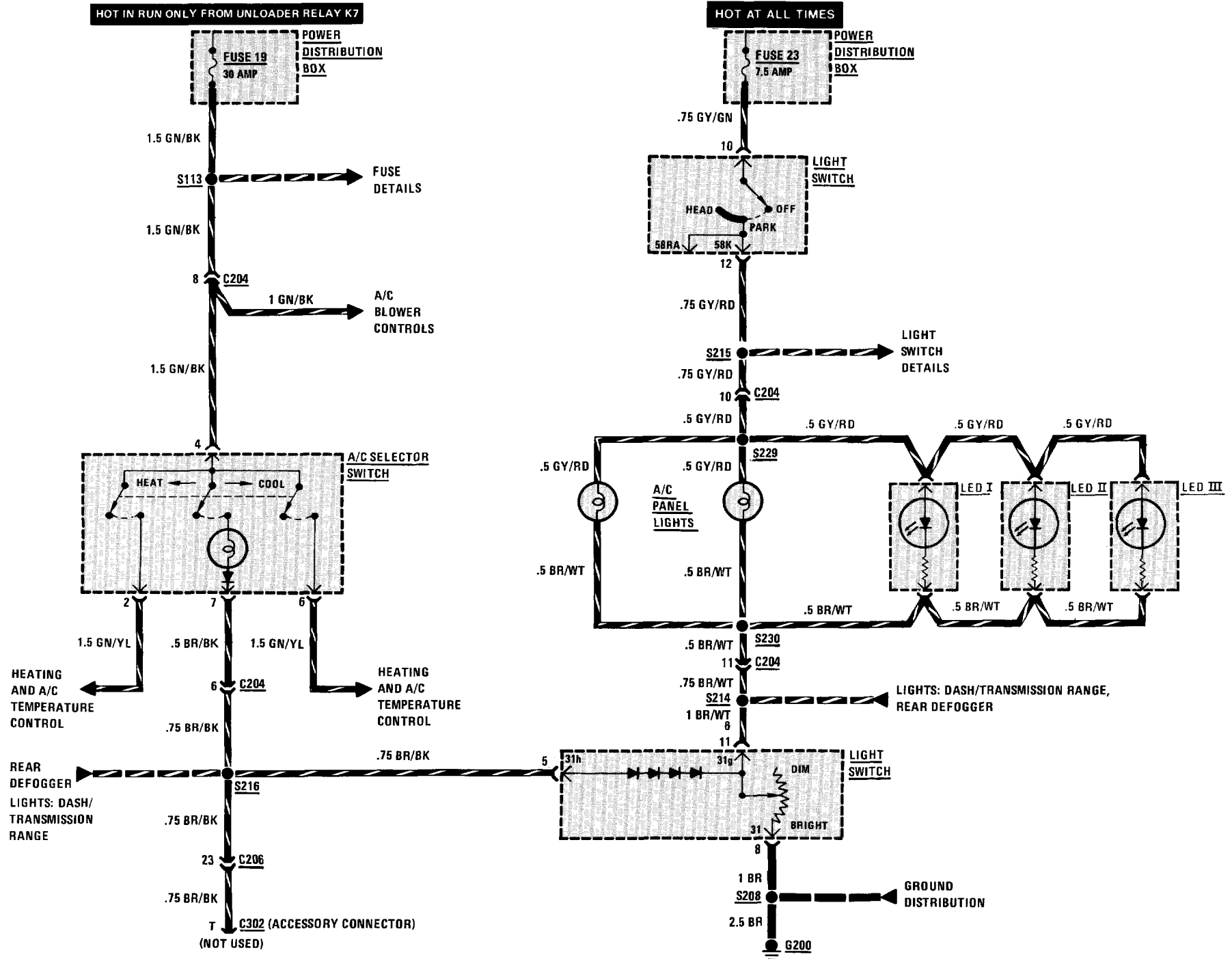

HEATING AND A/C TEMPERATURE CONTROL

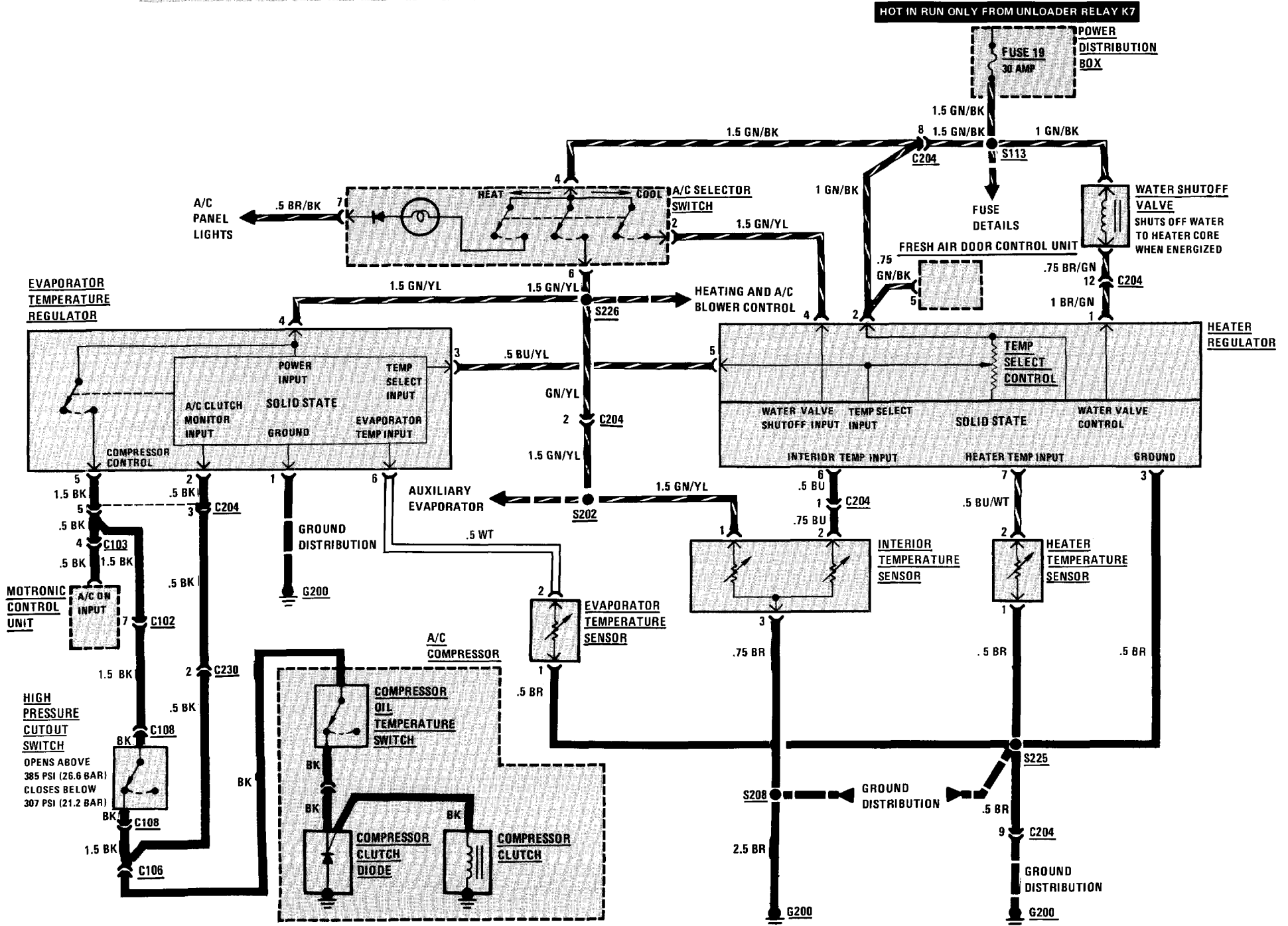

### HEATING AND A/C TEMPERATURE CONTROL

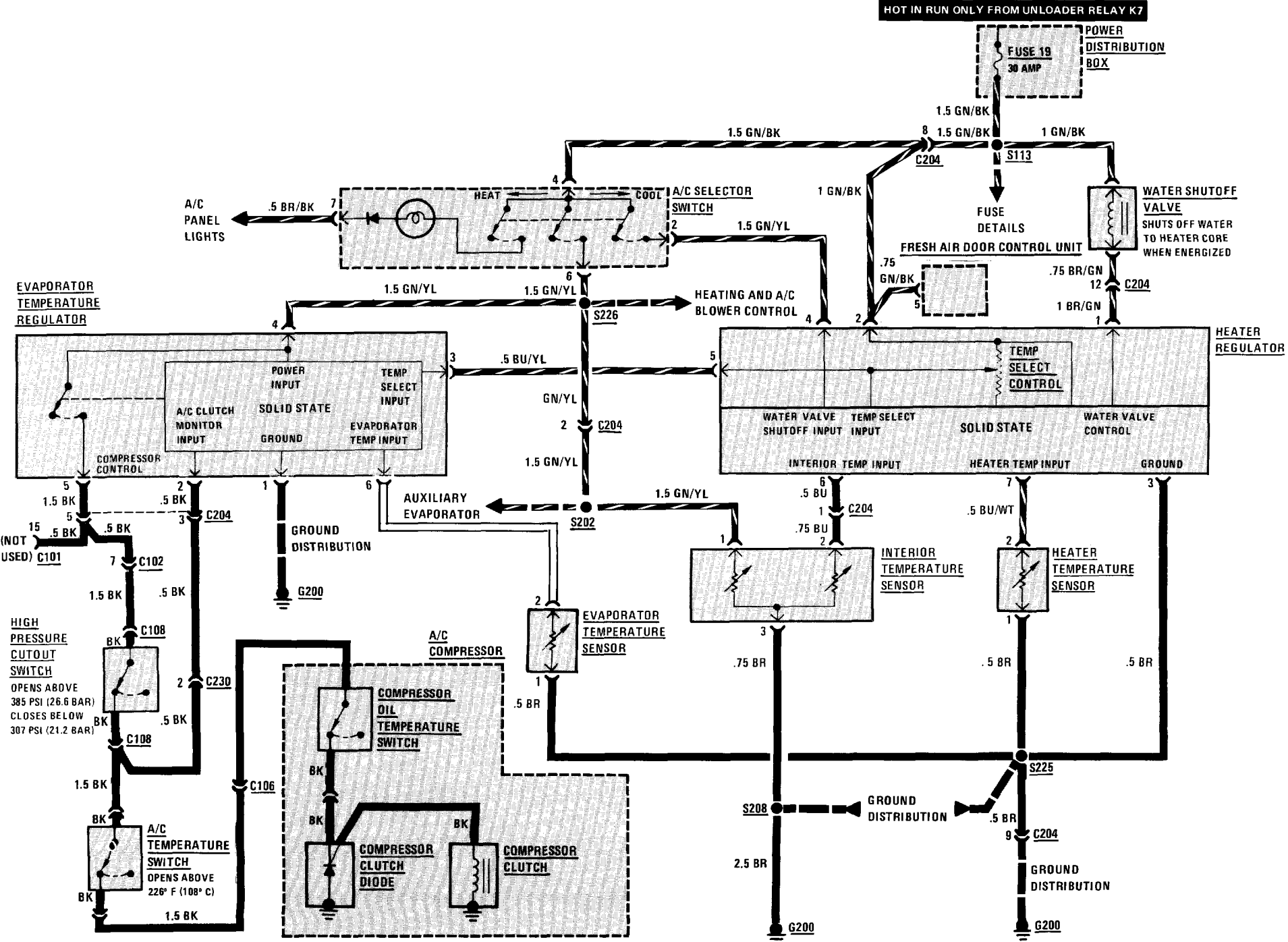

# 6413-0 A/C BLOWER CONTROLS

## HEATING AND A/C BLOWER CONTROL

HOT IN RUN ONLY FROM UNLOADER RELAY K7

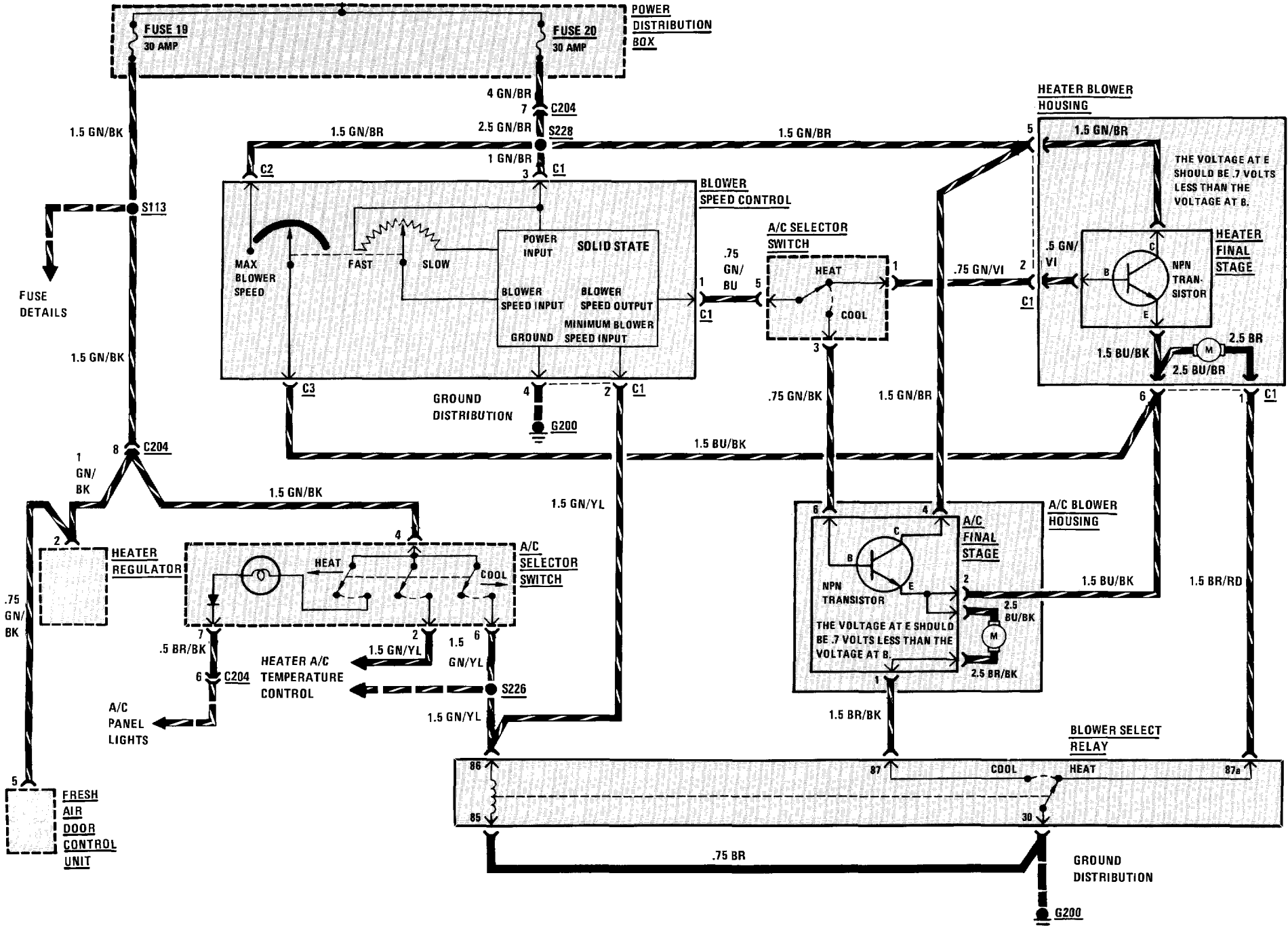

HEATING AND A/C BLOWER CONTROL

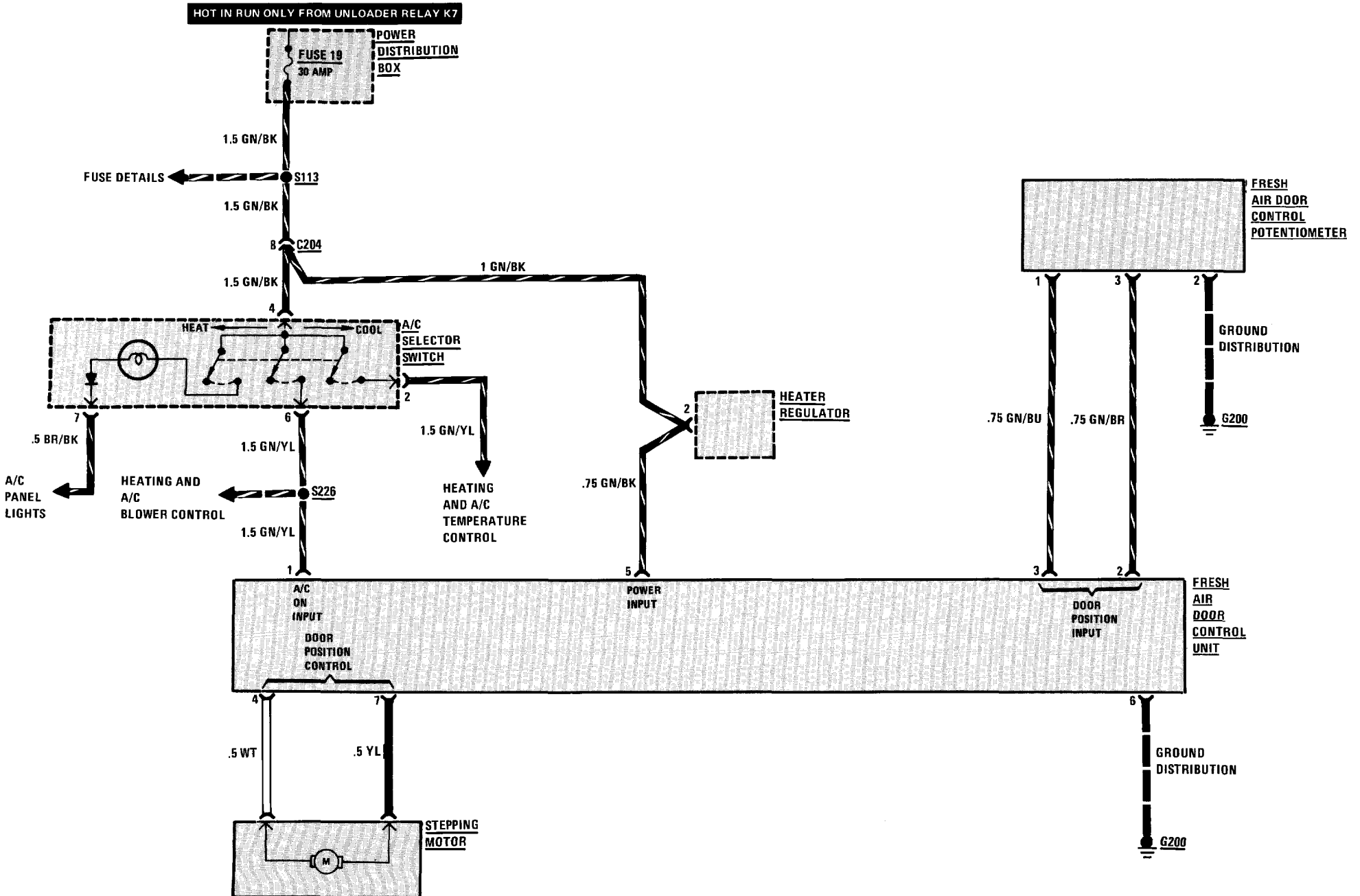

# 6414-0 REAR A/C EVAPORATOR

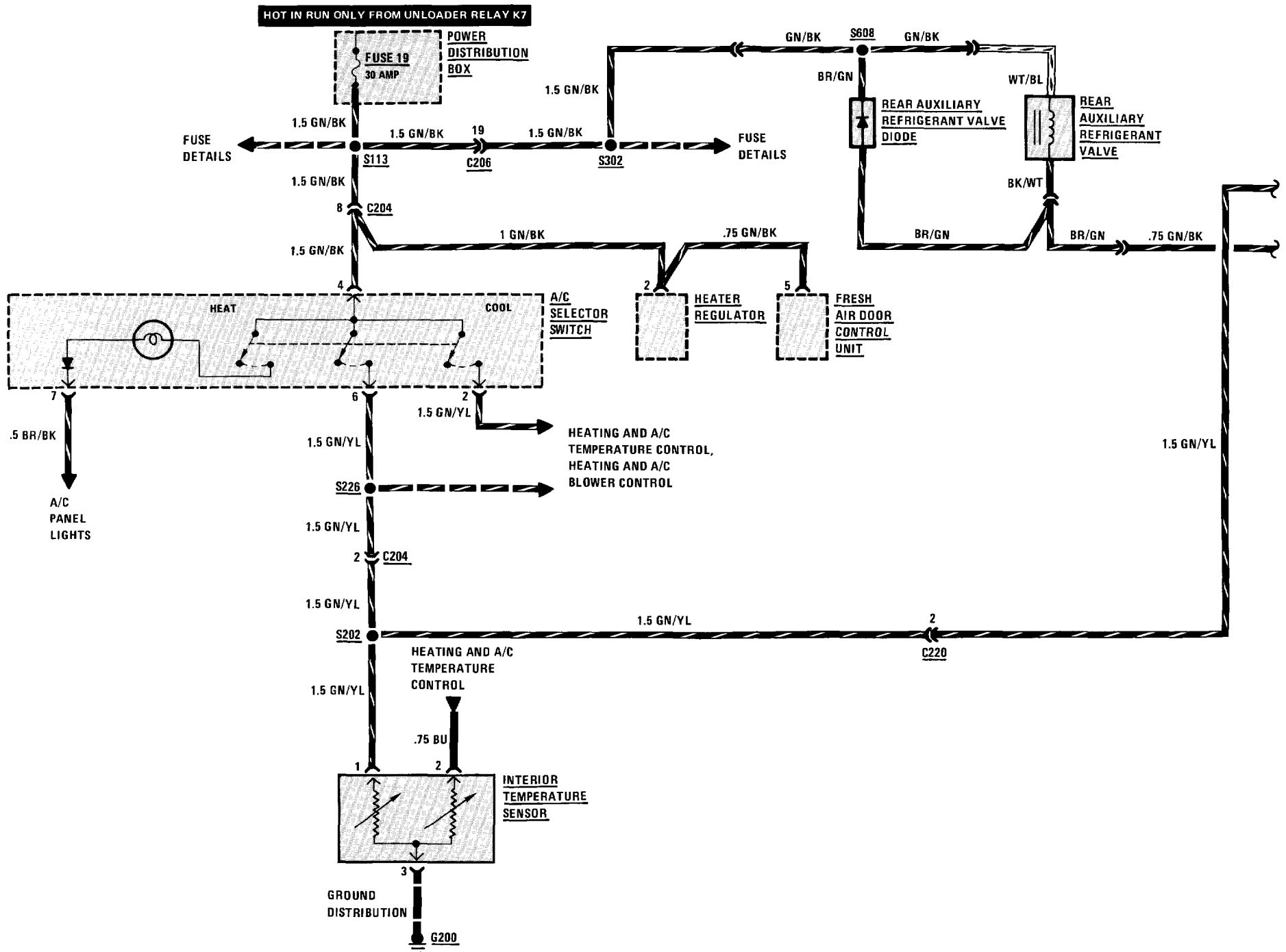



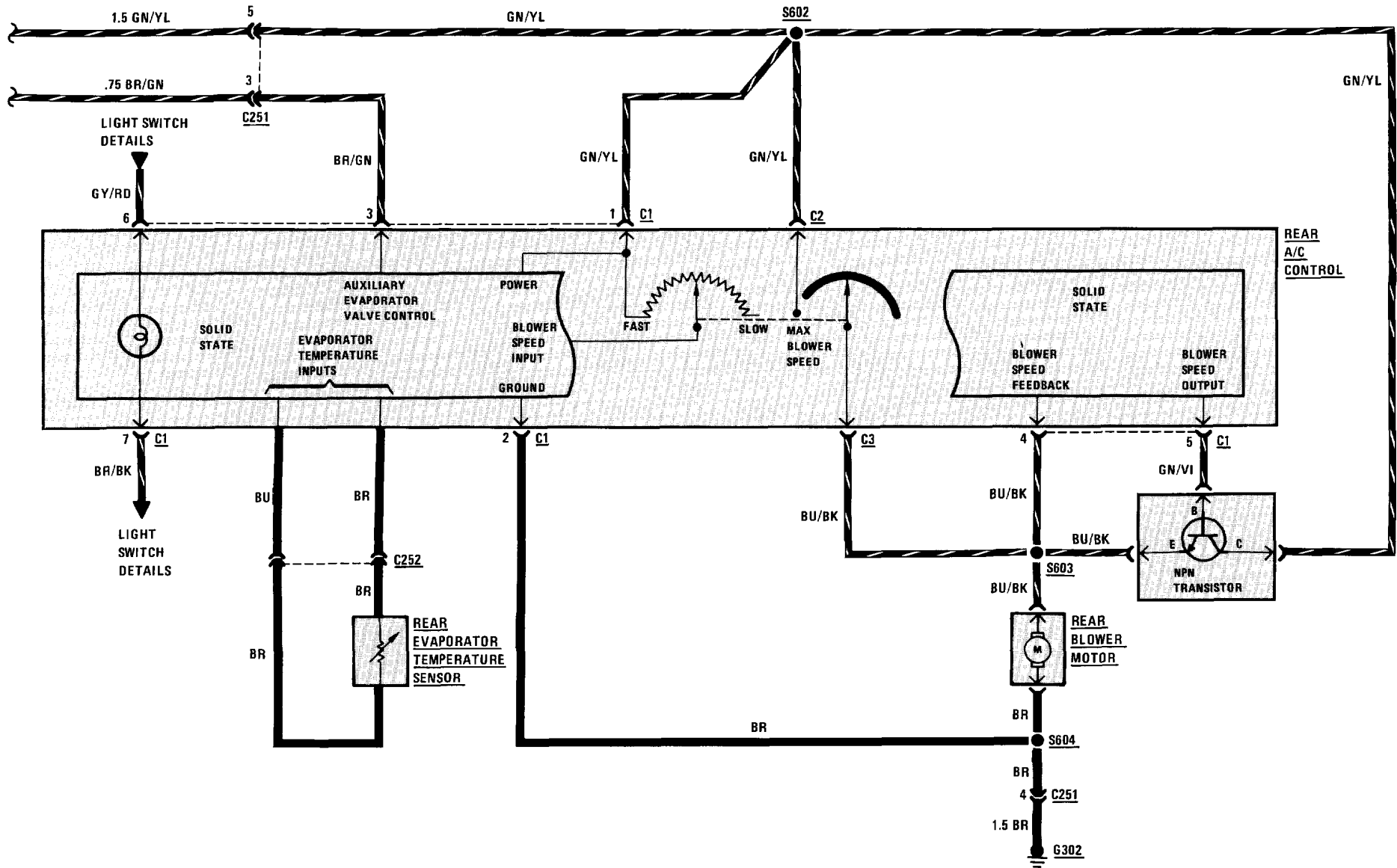

### CIRCUIT OPERATION

#### Blower Controls

With the Ignition Switch in RUN, battery voltage is applied through Fuse 20 to the Blower Speed Control at connector C2 and terminal 3 on connector C1, to the Heater Final Stage at terminal 5, and to the A/C Final Stage at terminal 4. When the Blower Speed Control is set to SLOW, a very low voltage (less than 1 volt) is output at terminal 1 on connector C1 to the A/C Selector Switch. If the A/C Selector Switch is in the HEAT position (not depressed), the low voltage from the Blower Speed Control is directed to the Heater Final Stage at terminal 2.

The Heater Final Stage determines the amount of voltage applied to the Heater Blower Motor and also provides the current to operate the Motor. The voltage applied is approximately 0.7 volts less than the input voltage to the Heater Final Stage at terminal 2. The Heater Blower Motor is grounded through the normally closed contacts of the Blower Select Relay.

Both the Heater Blower Motor and the A/C Blower Motor are variable speed Motors that run at a speed proportional to the applied voltage. At low applied voltage, the Blower Motor runs at very low speed.

As the Blower Speed Control is increased toward FAST, the output voltage at terminal 1 on connector C1 of the Blower Speed Control gradually increases to a maximum of about 10 volts, which is applied to the input of the Heater Final Stage. The output voltage from the Heater Final Stage increases at a level approximately 0.7 volts less than the input and drives

the Heater Blower at faster speed.

If the Blower Speed Control is moved to the maximum speed position (fully clockwise), battery voltage at connector C2 is applied through the Blower Speed Control and then directly to the Heater Blower. The Heater Blower runs at maximum speed.

When the A/C Selector Switch is in COOL (depressed), battery voltage at Fuse 19 is applied through the A/C Selector Switch at terminals 4 and 6 to the coil of the Blower Select Relay and to the Minimum Blower Speed Input Enable at terminal 2 on connector C1 of the Blower Speed Control.

Operation of the Blower Select Relay removes the ground from the Heater Blower Motor (BR/RD wire) and grounds the A/C Blower Motor (BR/BK wire). At the same time, a different section of the A/C Selector Switch directs the Blower Speed Output at terminal 1 on connector C1 of the Blower Speed Control to the input (terminal 6) of the A/C Final Stage.

Operation of the A/C Final Stage is similar to that of the Heater Final Stage. The Blower Speed Control now controls the speed of the A/C Blower instead of the Heater Blower. The only exception to the operation is that at minimum speed the output from the Blower Speed Control does not drop below approximately 3 volts. This ensures that blower speed does not drop so low that freezing of the Evaporator takes place.

#### Temperature Control

The in-car temperature is controlled by the Heater Regulator and Evaporator Temperature Regulator. In Heater mode operation

(A/C Selector Switch not depressed), the temperature of air flow into the car is determined by the operation of the Water Shutoff Valve. If the in-car temperature is significantly lower than the setting of the Temperature Selector Control, the Water Shutoff Valve remains open (de-energized), allowing a continuous flow of engine coolant through the heater core. As the in-car temperature approaches the setting of the Temp Select Control, the Heater Regulator grounds terminal 1 at about 4-second intervals, which energizes the Water Shutoff Valve at the same rate. The intermittent flow of engine coolant through the heater core reduces the average temperature of the air flow into the car. If the in-car temperature rises above the setting of the Temp Select Control, the Heater Regulator will ground terminal 1 continuously, shutting off the coolant flow through the heater core. In-car and heater core temperatures are input to the Heater Regulator at terminals 6 and 7.

In A/C mode operation (A/C Selector Switch depressed), battery voltage is applied to terminal 4 of the Heater Regulator, indicating that the Water Shutoff Valve should be energized continuously. This removes all heat from the heater core. Battery voltage is also applied to terminal 4 of the Evaporator Temperature Regulator. When the setting of the Temp Select Control is below the in-car temperature, the voltage at terminal 3 of the Evaporator Temperature Regulator is at a level which enables the Compressor Control output. Battery voltage is then applied from terminal 5 to the Compressor Clutch through the High Pressure Cut-out Switch and the Temperature Switch (S38 engine).

The High Pressure Cutout Switch opens if refrigerant pressure rises to a value which is too high for normal operation. The Temperature Switch (S38 Engine) opens to remove the Compressor load from the engine if the engine coolant temperature rises above 226 °F (108 °C). The Evaporator Temperature Sensor signals the Evaporator Temperature Regulator to de-energize the Compressor Clutch when evaporator temperature is low enough that freezing may result.

Whenever the Compressor Clutch is de-energized, the magnetic field around the coil collapses, generating an induced voltage in the coil. The Compressor Clutch Diode provides a path for the current resulting from the induced voltage.

#### Fresh Air Door Control

The Fresh Air Door Control Unit determines whether outside air will be drawn into the car or in-car air will be recirculated. The Air Flap Door is moved by the Stepping Motor connected to the Fresh Air Door Control Unit. Battery voltage is applied to the Control Unit at terminal 5 when the Ignition Switch is in RUN.

Battery voltage is applied to the Fresh Air Door Control Potentiometer from terminal 2 of the Fresh Air Door Control Unit. The position of the Potentiometer determines the voltage input to terminal 3 of the Control Unit, which then operates the door.

In the A/C Mode, battery voltage is applied to terminal 1 through the A/C Selector Switch. This signals the Fresh Air Door Control Unit to move the door to the fully open position.

#### Rear A/C Evaporator

The Rear A/C Evaporator receives battery voltage at terminal 5 when the Ignition Switch is in RUN and the A/C Selector Switch is in COOL (depressed). Voltage is then applied to the Blower Speed Control and Evaporator Temperature Regulator in the rear unit.

When the setting of the Temp Select Control is such that cooling is required in the rear of the vehicle, the Evaporator Temperature Regulator grounds terminal 3 to energize the Auxiliary Evaporator Valve. This cools the air flowing through the Auxiliary Evaporator to the rear vehicle area.

When the temperature in the rear vehicle area has reached the point set by the Temperature Control, the Evaporator Temperature Regulator de-energizes the Auxiliary Evaporator Valve so that no further cooling takes place. After the vehicle rear area temperature or evaporator temperature has risen to a point where cooling is required again, the Auxiliary Evaporator Valve is re-energized.

#### TROUBLESHOOTING HINTS

- Try the following checks before doing the System Check.
1. Check Fuse 19 and Fuse 20 by visual inspection.
  2. Check that connectors are firmly seated on the Heater Regulator, Water Shutoff Valve, Interior Temperature Sensor, and Compressor Clutch.

- If either the Heater Blower or A/C Blower does not operate at slow speeds but both Blowers operate at maximum speed, replace the Final Stage for the affected Blower.
- Go to System Check for a guide to normal operation.
- Go to System Diagnosis for diagnostic tests.

#### SYSTEM CHECK

This procedure is an overall check of the Heating and Air Conditioning System. Each of the steps can be performed without the use of tools and without disassembly.

Even though one or more steps may not give the correct result, complete all of the steps to reveal all the symptoms that may exist. Refer to System Diagnosis when a result is not normal.

Complete this procedure with the temperature outside the car above 60 °F (16 °C) and the engine running at idle.

## 6440A-2 HEATING AND AIR CONDITIONING

(Continued from previous page)

### SYSTEM CHECK TABLE

ACTION	NORMAL RESULT
Set Temp Select Control fully counterclockwise. Set all Slide Levers to extreme right. Set Blower Speed Control fully counterclockwise.	Blowers do not run.
Rotate Blower Speed Control slowly to fully clockwise position.	Blower speed gradually increases to maximum. Air at outside temperature is drawn into car.
Move Center Slide Lever to the left.	Sound of air flow changes as Air Flap Doors are repositioned.
Move Center Slide Lever to the right.	Sound of air flow changes again as Air Flap Doors return to original position.
Rotate Temp Select Control to fully clockwise position.	Air flow becomes warm.
Set Temp Select Control to temperature slightly higher than existing in-car temperature. Close car doors and windows.	Heater Regulator maintains in-car temperature at approximate Temperature Control setting.
Return Blower Speed Control to fully counterclockwise position.	Blower stops operating.
Press A/C Selector Switch.	Evaporator Blower runs slowly.
Rotate Blower Speed Control slowly to fully clockwise position.	Blower speed gradually increases to maximum.
Rotate Temp Select Control fully counterclockwise.	A/C Compressor operates. Air flow becomes cold. Engine Auxiliary Fan operates when Compressor Clutch is energized.
Set Temp Select Control to temperature slightly lower than in-car temperature. Close car doors and windows.	Evaporator Temperature Regulator maintains in-car temperature at approximate setting of Temperature Control.
Return Blower Speed Control to fully counterclockwise position.	Blower runs at minimum speed.
Rotate Rear A/C Unit Blower Speed Control to fully clockwise position.	Rear Blower runs at maximum speed.
Set Rear A/C Unit Temperature Control to fully counterclockwise position.	Air flow from Rear A/C Unit becomes cold.
Set Rear A/C Unit Temperature Control to temperature slightly lower than in-car temperature.	Rear A/C Unit maintains temperature in rear of car at approximate setting of Rear Temperature Control.

- If all of the above steps can be completed as described, the Heating and Air Conditioning System is operating normally.

**SYSTEM DIAGNOSIS**

- Do the tests listed for your symptom in the Symptom Table below.
- Tests follow the Symptom Table.

**SYMPTOM TABLE**

SYMPTOM	DO TEST
Heater Blower runs, but air flow does not become warm.	A and B
Heater Blower does not run at slow speed settings.	G
Heater Blower does not run in any mode setting.	H and J
A/C Blower runs, but air flow does not become cool.	C
A/C Blower does not run at slow speed settings.	G and I
A/C Blower does not run in any mode setting.	I and J
Fresh Air Door does not operate correctly.	K
Rear A/C Unit does not operate.	L

**A: HEATER REGULATOR TEST (TABLE 1) (Refer to Schematic on Pages 6411-0 or 6411-1)**

<b>Measure: VOLTAGE</b> <b>At: HEATER REGULATOR CONNECTOR (Disconnected)</b> <b>Conditions:</b> <ul style="list-style-type: none"> <li>• Ignition Switch: RUN</li> <li>• A/C Selector Switch: OFF</li> </ul>		
Measure Between	Correct Voltage	For Diagnosis
2 & Ground	Battery	See 1
2 & 3	Battery	See 2
1 & 3	Battery	See 3
4 & 3	0 Volts	See 4
<ul style="list-style-type: none"> <li>• A/C Selector Switch: ON</li> </ul>		
4 & 3	Battery	See 5
<ul style="list-style-type: none"> <li>• If all voltages are correct, go to Table 2.</li> </ul> <ol style="list-style-type: none"> <li>1. Check the associated wire for an open (see schematic).</li> <li>2. Check the associated wire for an open to ground G200 (see schematic).</li> <li>3. Check that Water Shutoff Valve connector is firmly seated. Check the wires at the Water Shutoff Valve for an open. If wires and connector are good, replace the Water Shutoff Valve.</li> <li>4. Check the wire at terminal 4 for a wire to wire short to voltage. If wire is good, do Test F.</li> <li>5. Check the wire at terminal 4 for an open. If wire is good, do Test F.</li> </ol>		

**A: HEATER REGULATOR TEST (TABLE 2) (Refer to Schematic on Pages 6411-0 or 6411-1)**

<b>Measure: RESISTANCE</b> <b>At: HEATER REGULATOR CONNECTOR (Disconnected)</b> <b>Conditions:</b> <ul style="list-style-type: none"> <li>• Ignition Switch: OFF</li> <li>• Negative Battery Terminal: DISCONNECTED</li> </ul>		
Measure Between	Correct Resistance	For Diagnosis
6 & Ground	Approximately 11K ohms at 70°F (21°C)	See 1
7 & Ground	Approximately 11K ohms at 70°F (21°C)	See 2
<ul style="list-style-type: none"> <li>• If all resistances are correct, go to Test B.</li> </ul> <ol style="list-style-type: none"> <li>1. Check the wire at terminal 6 for an open or short to ground. Check the wire at terminal 3 of the Interior Temperature Sensor for an open (see schematic). If wires are good, replace the Interior Temperature Sensor.</li> <li>2. Check the wire at terminal 7 for an open or short to ground (see schematic). Check the wire at terminal 3 of the Interior Temperature Sensor for an open (see schematic). If wires are good, replace the Heater Temperature Sensor.</li> </ol>		

## 6440A-4 HEATING AND AIR CONDITIONING

(Continued from previous page)

### B: WATER SHUTOFF VALVE TEST (TABLE 1) (Refer to Schematic on Pages 6411-0 or 6411-1)

<b>Measure: VOLTAGE</b> <b>At: WATER SHUTOFF VALVE CONNECTOR</b> <b>(Disconnected)</b> <b>Condition:</b> <ul style="list-style-type: none"> <li>• Ignition Switch: RUN</li> </ul>		
Measure Between	Correct Voltage	For Diagnosis
Wire from Fuse 19 & Ground (see schematic)	Battery	See 1
<ul style="list-style-type: none"> <li>• If the voltage is correct, go to Table 2.</li> </ul> <ol style="list-style-type: none"> <li>1. Check the associated wire for an open to Fuse 19 (see schematic).</li> </ol>		

### B: WATER SHUTOFF VALVE TEST (TABLE 2) (Refer to Schematic on Pages 6411-0 or 6411-1)

<b>Connect: TEST LAMP</b> <b>At: WATER SHUTOFF VALVE CONNECTOR</b> <b>(Disconnected)</b> <b>Conditions:</b> <ul style="list-style-type: none"> <li>• Ignition Switch: RUN</li> <li>• Engine at operating temperature</li> <li>• Blower Speed Control: FAST</li> <li>• A/C Selector Switch: OFF</li> <li>• Temp Select Control: Fully Counterclockwise</li> </ul>		
Connect Between	Correct Result	For Diagnosis
Water Shutoff Valve Terminals	Test Lamp Lights	See 1

(Continued in next column)

(Continued from previous column)

<ul style="list-style-type: none"> <li>• Temp Select Control fully clockwise</li> </ul>		
Water Shutoff Valve Terminals	Test Lamp Does Not Light	See 1
<ul style="list-style-type: none"> <li>• Temp Select Control at temperature setting the same as existing in-car temperature</li> </ul>		
Water Shutoff Valve Terminals	Test Lamp Flashes On And Off At Approximately 4-second Intervals	See 1
<ul style="list-style-type: none"> <li>• Temp Select Control fully clockwise</li> </ul>		
Water Shutoff Valve Terminals	Test Lamp Stays Off	See 1
<ul style="list-style-type: none"> <li>• If all results are correct, Heater Regulator is operating normally. If warm air is not generated in heat mode, replace the Heater Shutoff Valve.</li> </ul> <ol style="list-style-type: none"> <li>1. Replace Heater Regulator.</li> </ol>		

### C: A/C ISOLATION TEST (TABLE 1) (Refer to Schematic on Pages 6411-0 or 6411-1)

<b>Measure: VOLTAGE</b> <b>At: HIGH PRESSURE CUTOOUT SWITCH</b> <b>HARNES CONNECTOR C108</b> <b>(Disconnected)</b> <b>Conditions:</b> <ul style="list-style-type: none"> <li>• Ignition Switch: RUN (Engine need not be running)</li> <li>• Temp Select Control: 61 °F (Fully Counterclockwise)</li> <li>• A/C Selector Switch: Depressed (ON)</li> </ul>		
Measure Between	Correct Voltage	For Diagnosis
Wire to C102 & Ground	Battery	See 1
<ul style="list-style-type: none"> <li>• If the voltage is correct, go to Table 2 (S38 engine) or Table 3 (3.5 engine).</li> </ul> <ol style="list-style-type: none"> <li>1. Do Test E.</li> </ol>		

### C: A/C ISOLATION TEST (TABLE 2) (Refer to Schematic on Page 6411-1)

<b>Connect: FUSED JUMPER</b> <b>At: TEMPERATURE SWITCH HARNES</b> <b>CONNECTOR (Disconnected)</b> <b>Conditions:</b> <ul style="list-style-type: none"> <li>• Ignition Switch: RUN</li> <li>• Temp Select Control: 61 °F (Fully Counterclockwise)</li> <li>• A/C Selector Switch: ON</li> </ul>		
Connect Between	Correct Result	For Diagnosis
Temperature Switch Terminals	Compressor Clutch Engages	See 1
<ul style="list-style-type: none"> <li>• If the result is correct, check that Temperature Switch is closed. If the switch is open and engine coolant temperature is less than 226 °F (108 °C), replace the Temperature Switch.</li> </ul> <ol style="list-style-type: none"> <li>1. Do Test D.</li> </ol>		

**C: A/C ISOLATION TEST (TABLE 3)**  
(Refer to Schematic on Page 6411-0 or 6411-1)

**Connect: FUSED JUMPER**  
**At: HIGH PRESSURE CUTOUT SWITCH HARNESS CONNECTOR (Disconnected)**  
**Conditions:**

- Ignition Switch: RUN
- Temp Select Control: 61 °F (Fully Counterclockwise)
- A/C Selector Switch: ON

Connect Between	Correct Result	For Diagnosis
High Pressure Cutout Switch Terminals	Compressor Clutch Engages	See 1

- If the result is correct, check that High Pressure Cutout Switch is closed. If the Switch is open, replace it.

1. Do Test D.

**D: COMPRESSOR CLUTCH VOLTAGE TEST** (Refer to Schematic on Page 6411-0 or 6411-1)

**Measure: VOLTAGE**  
**At: COMPRESSOR CLUTCH HARNESS CONNECTOR (Disconnected)**  
**Conditions:**

- Ignition Switch: RUN (Engine need not be running)
- Temp Select Control: 61 °F (Fully Counterclockwise)
- A/C Selector Switch: ON

Measure Between	Correct Voltage	For Diagnosis
Wire & Ground	Battery	See 1

(Continued in next column)

(Continued from previous column)

- If the voltage is correct and the refrigerant charge is normal, but Compressor Clutch does not engage, replace the Compressor Clutch.

1. Check the wire for an open.

**E: EVAPORATOR TEMPERATURE REGULATOR VOLTAGE AND RESISTANCE TEST (TABLE 1)** (Refer to Schematic on Page 6411-0 or 6411-1)

**Measure: VOLTAGE**  
**At: EVAPORATOR TEMPERATURE REGULATOR CONNECTOR (Disconnected)**  
**Conditions:**

- Ignition Switch: RUN
- Temp Select Control: 61 °F (Fully Counterclockwise)
- A/C Selector Switch: ON

Measure Between	Correct Voltage	For Diagnosis
4 & Ground	Battery	See 1
4 & 1	Battery	See 2
3 & Ground	Less than 0.5 Volts	See 3
• Turn Temp Select Control to 87 °F (Fully Clockwise)		
3 & Ground	Approximately 8 Volts	See 4
• A/C Selector Switch: OFF		
4 & Ground	0 Volts	See 5

(Continued in next column)

(Continued from previous column)

- If all voltages are correct, go to Table 2.

1. Check the associated wire for an open (see schematic). If wire is good, do Test F.
2. Check the wire at terminal 1 for an open to splice S225.
3. If higher voltage is present, replace Heater Regulator.
4. Voltage should increase smoothly to 8 volts as Temp Select Control is turned clockwise. If no voltage is present, check associated wire for an open (see schematic). If wire is good or voltage does not increase uniformly, replace the Heater Regulator.
5. Check the associated wire for a wire to wire short to voltage. If wire is good, replace the A/C Selector Switch.

**E: EVAPORATOR TEMPERATURE REGULATOR VOLTAGE AND RESISTANCE TEST (TABLE 2)** (Refer to Schematic on Page 6411-0 or 6411-1)

**Measure: RESISTANCE**  
**At: EVAPORATOR TEMPERATURE REGULATOR CONNECTOR (Disconnected)**  
**Conditions:**

- Ignition Switch: OFF
- Negative Battery Terminal: DISCONNECTED

Measure Between	Correct Voltage	For Diagnosis
5 & Ground	Approximately 3 to 4 Ohms	See 1
5 & 2	Less than 0.5 ohms	See 3

(Continued on next page)

# 6440A-6 HEATING AND AIR CONDITIONING

(Continued from previous page)

6 & Ground	Approximately 3.5K to 4.5K ohms at 70°F (21°C)	See 2
<ul style="list-style-type: none"> <li>If both resistances are correct, but Compressor Clutch does not operate normally, replace the Evaporator Temperature Regulator.</li> </ul> <ol style="list-style-type: none"> <li>Check the associated wire for an open between the Evaporator Temperature Regulator terminal 5 and High Pressure Cutout Switch (see schematic).</li> <li>Check the associated wire for an open or a short to ground (see schematic). Check the associated wire from terminal 1 to splice S225 for an open (see schematic). If wires are good, replace the Evaporator Temperature Sensor.</li> <li>Check wire at Terminal 2 for an open between Terminal 2 and connector C106.</li> </ol>		

## F: A/C SELECTOR SWITCH VOLTAGE TEST (Refer to Schematic on Page 6411-0 or 6411-1)

<b>Measure: VOLTAGE</b> <b>At: A/C SELECTOR SWITCH CONNECTOR (Disconnected)</b> <b>Conditions:</b> <ul style="list-style-type: none"> <li>Ignition Switch: RUN</li> <li>Blower Speed Control: 3</li> </ul>		
Measure Between	Correct Voltage	For Diagnosis
4 & Ground	Battery	See 1
4 & 6	Battery	See 2
4 & 2	Battery	See 3
4 & 7	Battery	See 4
<ul style="list-style-type: none"> <li>If all voltages are correct, but A/C Selector Switch does not operate normally, replace it.</li> </ul> <ol style="list-style-type: none"> <li>Check the associated wire for an open (see schematic). If wire is good, check Fuse 19.</li> <li>Check the wire at terminal 6 for an open (see schematic).</li> <li>Check the wire at terminal 2 for an open (see schematic).</li> <li>Check the wire at terminal 7 for an open (see schematic).</li> </ol>		

## G: BLOWER SPEED CONTROL VOLTAGE TEST (TABLE 1) (Refer to Schematic on Page 6413-0)

<b>Measure: VOLTAGE</b> <b>At: BLOWER SPEED CONTROL CONNECTOR (Disconnected)</b> <b>Conditions:</b> <ul style="list-style-type: none"> <li>Ignition Switch: RUN</li> <li>Blower Speed Control: MINIMUM</li> <li>A/C Selector Switch: OFF</li> </ul>		
Measure Between	Correct Voltage	For Diagnosis
C1/3 & Ground	Battery	See 1
C1/3 & C1/4	Battery	See 2
C2 & Ground	Battery	See 3
C1/2 & Ground	0 Volts	See 4
<ul style="list-style-type: none"> <li>A/C Selector Switch: ON</li> </ul>		
C1/2 & Ground	Battery	See 3
<ul style="list-style-type: none"> <li>If all voltages are correct but Speed Control setting will not vary Blower speed, go to Table 2.</li> </ul> <ol style="list-style-type: none"> <li>Check the associated wire for an open back to Fuse 20 (see schematic).</li> <li>Check the wire to terminal 4 for an open to ground G200 (see schematic)</li> <li>Check the associated wire for an open (see schematic).</li> <li>Check the associated wire for a wire to wire short to voltage (see schematic). If the wire is good, do Test F.</li> </ol>		



**G: BLOWER SPEED CONTROL VOLTAGE TEST (TABLE 2) (Refer to Schematic on Page 6413-0)**

<b>Measure: VOLTAGE</b> <b>At: A/C SELECTOR SWITCH CONNECTOR (Disconnected)</b> <b>Conditions:</b> <ul style="list-style-type: none"> <li>• Ignition Switch: RUN</li> <li>• Blower Speed Control: SLOW</li> <li>• Blower Speed Control: CONNECTED</li> </ul>		
Measure Between	Correct Voltage	For Diagnosis
5 & Ground	Less than 0.5 Volts	See 1
• Blower Speed: FAST		
5 & Ground	Approximately 10 Volts	See 2
<ul style="list-style-type: none"> <li>• A/C Selector Switch Connector: Reconnected</li> <li>• A/C Selector Switch: OFF</li> </ul>		
1 & Ground	Approximately 10 Volts	See 3
• A/C Selector Switch: ON		
3 & Ground	Approximately 10 Volts	See 4
• Blower Speed: SLOW		
3 & Ground	Approximately 3 Volts	See 5

(Continued in next column)

(Continued from previous column)

- If all voltages are correct but blower motors do not operate normally, do Test H or I.
1. If the voltage is greater than 0.5 volts, replace the Blower Speed Control.
  2. Check the associated wire for an open (see schematic). If the wire is good, replace the Blower Speed Control.
  3. Check the associated wire for a short to ground (see schematic). If the wire is good, do Test H.
  4. Check the associated wire for a short to ground (see schematic). If the wire is good, do Test I.
  5. Replace the Blower Speed Control.

**H: HEATER FINAL STAGE VOLTAGE TEST (Refer to Schematic on Page 6413-0)**

<b>Measure: VOLTAGE</b> <b>At: HEATER BLOWER HOUSING CONNECTOR C1 (Disconnected)</b> <b>Conditions:</b> <ul style="list-style-type: none"> <li>• Ignition Switch: RUN</li> <li>• Blower Speed Control: FAST</li> <li>• A/C Selector Switch: OFF</li> </ul>		
Measure Between	Correct Voltage	For Diagnosis
5 & Ground	Battery	See 1
2 & Ground	Approximately 10 Volts	See 2
6 & Ground	Battery	See 2
6 & 1	Battery	See 3
<ul style="list-style-type: none"> <li>• If all voltages are correct but Heater Blower does not run, replace the Heater Blower.</li> </ul> <ol style="list-style-type: none"> <li>1. Check the associated wire for an open back to Fuse 20 (see schematic).</li> <li>2. Check the associated wire for an open (see schematic).</li> <li>3. Check the wire at terminal 1 for an open (see schematic). If the wire is good, do Test J.</li> </ol>		

(Continued on next page)

## 6440A-8 HEATING AND AIR CONDITIONING

(Continued from previous page)

### I: A/C FINAL STAGE VOLTAGE TEST (Refer to Schematic on Page 6413-0)

<b>Measure: VOLTAGE</b> <b>At: A/C BLOWER HOUSING CONNECTOR</b> (Disconnected) <b>Conditions:</b> <ul style="list-style-type: none"> <li>• Ignition Switch: RUN</li> <li>• Blower Speed Control: FAST</li> <li>• A/C Selector Switch: ON</li> </ul>		
Measure Between	Correct Voltage	For Diagnosis
4 & Ground	Battery	See 1
6 & Ground	Approximately 10 Volts	See 1
2 & Ground	Battery	See 1
2 & 1	Battery	See 2
<ul style="list-style-type: none"> <li>• If all voltages are correct but A/C Blower does not run, replace the A/C Blower.</li> </ul> <ol style="list-style-type: none"> <li>1. Check the associated wire for an open (see schematic).</li> <li>2. Check the wire at terminal 1 for an open (see schematic). If the wire is good, do Test J.</li> </ol>		

### J: BLOWER SELECT RELAY VOLTAGE TEST (Refer to Schematic on Page 6413-0)

<b>Measure: VOLTAGE</b> <b>At: BLOWER SELECT RELAY (Disconnected)</b> <b>Conditions:</b> <ul style="list-style-type: none"> <li>• Ignition Switch: RUN</li> <li>• Blower Speed Control: FAST</li> <li>• A/C Selector Switch: Depressed (ON)</li> </ul>		
Measure Between	Correct Voltage	For Diagnosis
86 & Ground	Battery	See 1
86 & 85	Battery	See 2
87 & Ground	Battery	See 3
87a & Ground	Battery	See 4
<ul style="list-style-type: none"> <li>• If all voltages are correct but either the A/C Blower or Heater Blower will not operate with Blower Speed at FAST, replace the Blower Select Relay.</li> </ul> <ol style="list-style-type: none"> <li>1. Check the associated wire for an open to splice S226 (see schematic). If wire is good, do Test F.</li> <li>2. Check the wire at terminal 85 for an open to ground G200 (see schematic).</li> <li>3. Check the associated wire for an open back to terminal 1 of the A/C Blower Housing (see schematic).</li> <li>4. Check the associated wire for an open back to terminal 1 of the Heater Blower Housing (see schematic).</li> </ol>		

### K: FRESH AIR DOOR CONTROL UNIT VOLTAGE TEST (TABLE 1)(Refer to Schematic on Page 6413-1)

<b>Measure: VOLTAGE</b> <b>At: FRESH AIR DOOR CONTROL UNIT CONNECTOR (Disconnected)</b> <b>Conditions:</b> <ul style="list-style-type: none"> <li>• Ignition Switch: RUN</li> <li>• A/C Selector Switch: Not Depressed (OFF)</li> </ul>		
Measure Between	Correct Voltage	For Diagnosis
5 & Ground	Battery	See 1
5 & 6	Battery	See 2
1 & 6	0 Volts	See 3
<ul style="list-style-type: none"> <li>• A/C Selector Switch: Depressed (ON)</li> </ul>		
1 & 6	Battery	See 4
<ul style="list-style-type: none"> <li>• If all voltages are correct, go to Table 2.</li> </ul> <ol style="list-style-type: none"> <li>1. Check the associated wire for an open (see schematic). If wire is good, check Fuse 19.</li> <li>2. Check the associated wire for an open between terminal 6 and ground G200 (see schematic).</li> <li>3. If the voltage is present, check the wire at terminal 1 for a wire to wire short to voltage. If the wire is good, replace the A/C Selector Switch.</li> <li>4. Check the wire at terminal 1 for an open to splice S226 (see schematic).</li> </ol>		

**K: FRESH AIR DOOR CONTROL UNIT VOLTAGE TEST (TABLE 2) (Refer to Schematic on Page 6413-1)**

<b>Measure: RESISTANCE</b> <b>At: FRESH AIR DOOR CONTROL UNIT CONNECTOR (Disconnected)</b> <b>Conditions:</b> <ul style="list-style-type: none"> <li>• Ignition Switch: OFF</li> <li>• Negative Battery Terminal: DISCONNECTED</li> <li>• Center Slide Lever at extreme left</li> </ul>		
Measure Between	Correct Resistance	For Diagnosis
2 & Ground	10K ohms ± 1K ohm	See 1
3 & Ground	10K ohms ± 1K ohm	See 2
• Center Slide Lever at extreme right		
3 & Ground	Less than 500 Ohms	See 3
4 & 7	60 to 70 Ohms	See 4

- If all resistances are correct but Fresh Air Door does not operate, replace the Fresh Air Door Control Unit.
1. Check the associated wire and the wire at terminal 3 of the Fresh Air Door Control Potentiometer for an open (see schematic). If the wires are good, replace the Fresh Air Door Control Potentiometer.
  2. Check the associated wire for an open (see schematic). If the wire is good, replace the Fresh Air Door Control Potentiometer.
  3. Replace the Fresh Air Door Control Potentiometer.
  4. Check the wires at terminals 4 and 7 for an open or wire to wire short (see schematic). If the wires are good, replace the Stepping Motor.

**L: REAR A/C EVAPORATOR VOLTAGE TEST (Refer to Schematic on Page 6414-0)**

<b>Measure: VOLTAGE</b> <b>At: AUXILIARY EVAPORATOR CONNECTOR (Disconnected)</b> <b>Conditions:</b> <ul style="list-style-type: none"> <li>• Ignition Switch: RUN</li> <li>• Front A/C Selector Switch: ON</li> </ul>		
Measure Between	Correct Voltage	For Diagnosis
5 & Ground	Battery	See 1
5 & 4	Battery	See 2
3 & Ground	Battery	See 3
<ul style="list-style-type: none"> <li>• If all voltages are correct, but air flow is not cooled, go to Test M.</li> </ul> <ol style="list-style-type: none"> <li>1. Check the associated wire for an open back to splice S202 (see schematic). Check that connector C220 is properly mated.</li> <li>2. Check the wire at terminal 4 for an open to ground G302 (see schematic).</li> <li>3. Check the associated wire for an open (see schematic). If the wire is good, do Test M.</li> </ol>		

## 6440A-10 HEATING AND AIR CONDITIONING

(Continued from previous page)

### M: AUXILIARY EVAPORATOR VALVE VOLTAGE TEST (TABLE 1) (Refer to Schematic on Page 6414-0)

<b>Measure: VOLTAGE</b> <b>At: AUXILIARY EVAPORATOR VALVE</b> <b>(Disconnected)</b> <b>Conditions:</b> <ul style="list-style-type: none"> <li>• Ignition Switch: RUN</li> <li>• Auxiliary Evaporator Connector: CONNECTED</li> </ul>		
Measure Between	Correct Voltage	For Diagnosis
1 & Ground	Battery	See 1
<ul style="list-style-type: none"> <li>• If the voltage is correct, go to Table 2.</li> </ul> <ol style="list-style-type: none"> <li>1. Check the associated wire for an open to Fuse 19.</li> </ol>		

### M: AUXILIARY EVAPORATOR VALVE VOLTAGE TEST (TABLE 2) (Refer to Schematic on Page 6414-0)

<b>Connect: TEST LAMP</b> <b>At: AUXILIARY EVAPORATOR VALVE</b> <b>(Disconnected)</b> <b>Conditions:</b> <ul style="list-style-type: none"> <li>• Ignition Switch: RUN</li> <li>• Front A/C Selector Switch: ON</li> <li>• Rear Blower Control: FAST</li> <li>• Rear Temperature Control: Fully Counterclockwise</li> </ul>		
Connect Between	Correct Result	For Diagnosis
1 & 2	Test Lamp Lights	See 1
<ul style="list-style-type: none"> <li>• Rear Temperature Control: Fully Clock- wise</li> </ul>		
1 & 2	Test Lamp Does Not Light	See 1
<ul style="list-style-type: none"> <li>• If both results are correct, Rear Tem- perature Control is operating normally. If cold air is not generated in cooling mode, replace the Auxiliary Evaporator Valve.</li> </ul> <ol style="list-style-type: none"> <li>1. Replace the Rear Temperature Regulator.</li> </ol>		

# 6454-0 AUXILIARY FAN

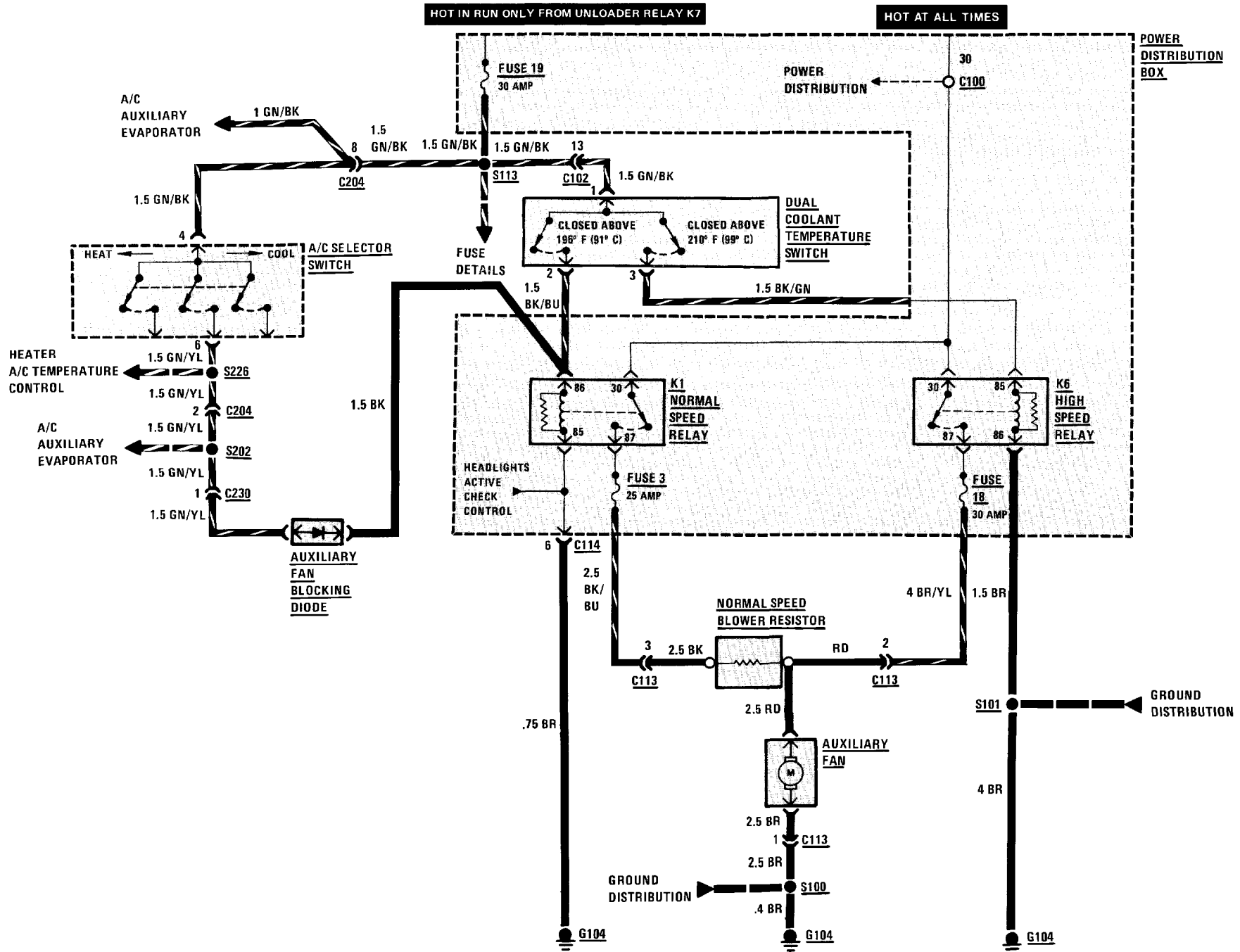

# 6500-0 RADIO/POWER ANTENNA

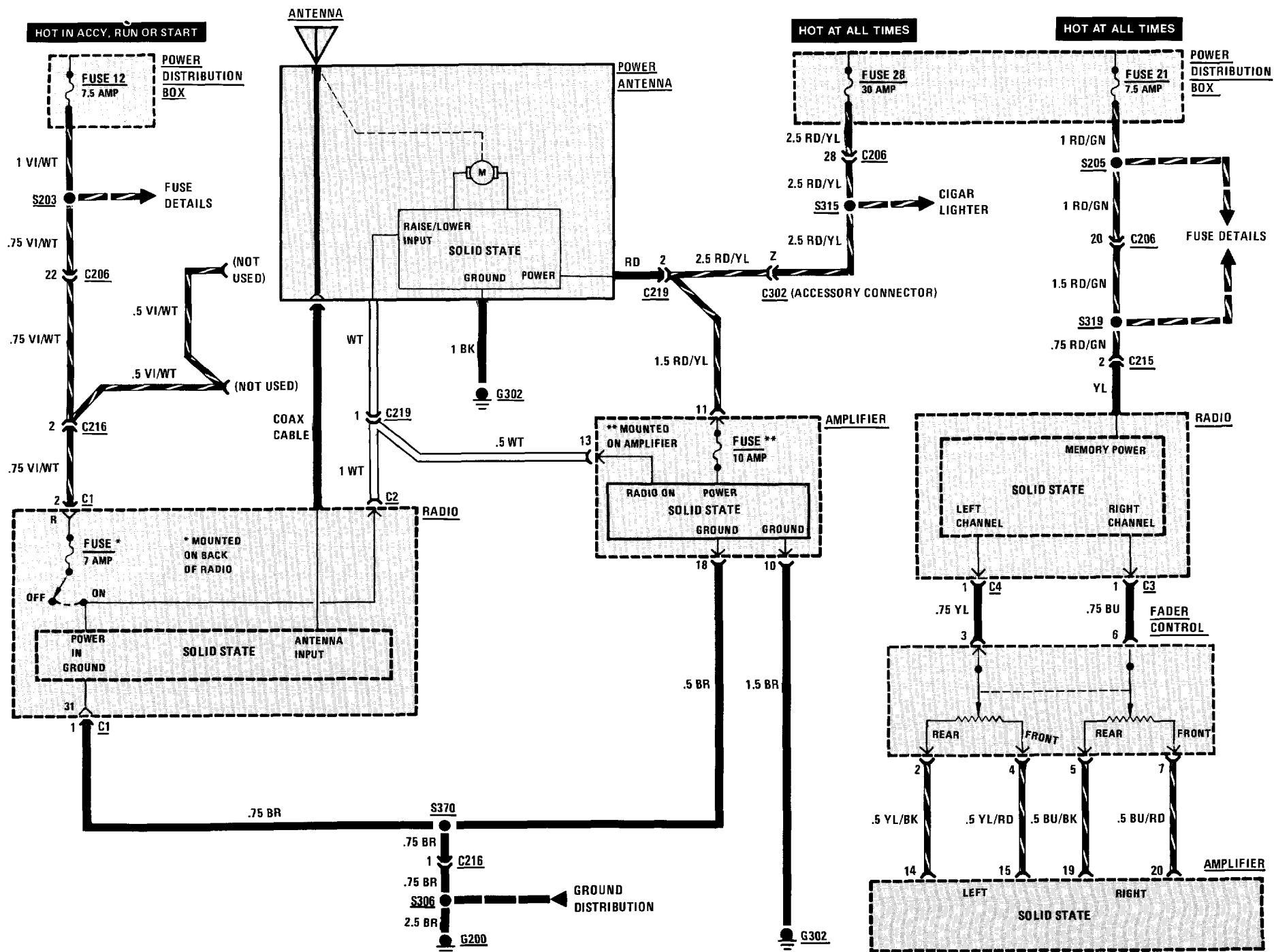

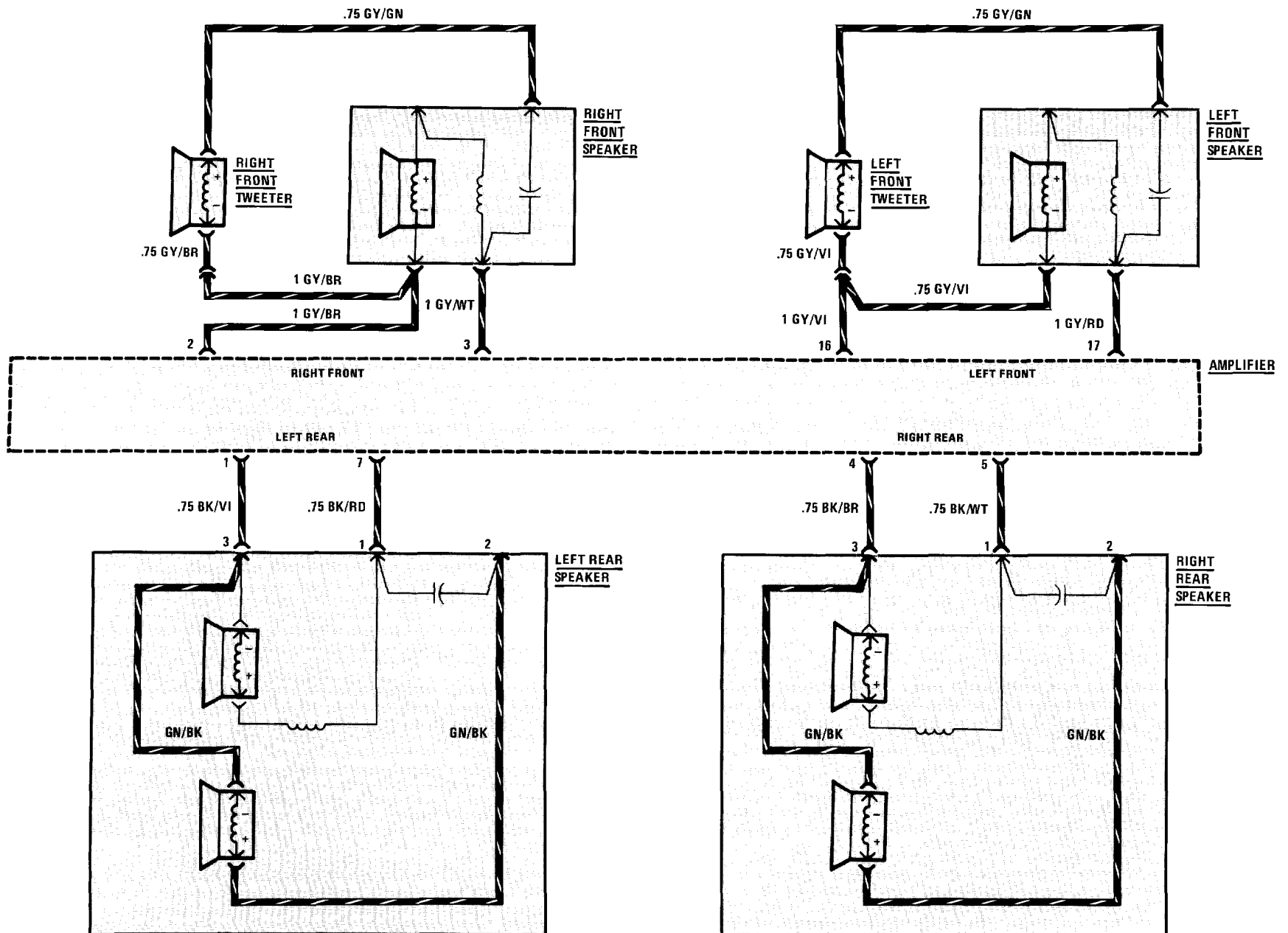

## CIRCUIT OPERATION

With the Ignition Switch in ACCY, RUN or START, Fuse 12 provides voltage to turn on the three components in the system. When the Radio Switch is on, voltage is applied to the Radio, the Power Antenna Raise/Lower Input, and the Amplifier. This voltage is used to control the individual unit's main power supply.

When the Raise/Lower Input of the Power Antenna receives voltage, power is supplied from Fuse 28 to run the motor and raise the Antenna. When voltage is no longer present at the Raise/Lower Input, the Antenna is lowered.

Fuse 21 constantly supplies voltage to the Memory Power Input of the Radio. This allows the Radio to maintain the present settings while it is turned off.

The Amplifier receives constant power at terminal 11 from Fuse 28. When the Radio is on, voltage is applied to terminal 13 to enable the Amplifier.

The actual Radio signal originates at the Antenna. It is supplied to the Radio, processed, and output from the Left Channel and Right Channel Outputs to the Fader Control. The Fader Control alters the front to rear volume by decreasing the resistance to the desired higher volume outputs. The signal is then input to the Left Front, Left Rear, Right Front, and Right Rear Inputs to the Amplifier. After amplification, the signal is output to the corresponding speakers.

## TROUBLESHOOTING HINTS

- Try the following checks before doing the System Check.
  1. Check power input to the Radio by observing if Instrument Cluster Indicators light.
  2. Check power input to Antenna by observing the Cigar Lighter.
  3. Check memory power to Radio by checking operation of the Glove Box Light.
  4. Check power input to the Amplifier.
  5. If Fader Control has no effect, but sound is heard from all speakers, replace the Fader Control.
  6. Check that the Antenna is properly connected.
  7. Before troubleshooting a suspect Speaker, check all connections to that Speaker.
  8. If display shows "CODE" and Radio will not operate, the individual Anti-Theft Code must be entered. Refer to "Anti-Theft" instruction booklet.
  9. Check Radio Fuse located on back of Radio.
  10. Check Amplifier Fuse located on back of Amplifier.
- Go to System Check for a guide to normal operation.
- Go to System Diagnosis for diagnostic tests.

## SYSTEM CHECK

- Use the System Check Table as a guide to normal operation.
- Refer to System Diagnosis for a list of symptoms and diagnostic steps.

### SYSTEM CHECK TABLE

ACTION	NORMAL RESULT
With Ignition Switch in RUN, turn Radio ON.	Antenna extends. Digital display lights. Sound is emitted from all Speakers.
Operate Fader Control.	Sound volume varies from front to rear.

- Refer to System Diagnosis when a result is not normal.

## SYSTEM DIAGNOSIS

- Do the tests listed for your symptom in the Symptom Table below.
- Tests follow the Symptom Table.

### SYMPTOM TABLE

SYMPTOM	FOR DIAGNOSIS
Radio does not work (no display, no sound).	Do Test A
Digital display lights, but there is no sound.	Do Test B
LH Speakers or RH Speakers do not operate.	Do Test C

(Continued on next page)



(Continued from previous page)

Antenna does not extend or retract.	Check ground wire for an open. Make sure ground G302 is clean and tight. Check wire to Power Antenna for opens. If OK, replace Power Antenna.
An individual Speaker does not operate.	Do Test D
Excessive noise comes from all Speakers.	Do Test E

**A: RADIO POWER TEST**

<b>Measure: VOLTAGE</b>		
<b>At: RADIO CONNECTOR C1 (Disconnected) or CONNECTOR C215 (Disconnected)</b>		
<b>Condition:</b>		
• Ignition Switch: RUN		
Measure Between	Correct Voltage	For Diagnosis
C1/2 & Ground	Battery	See 1
C1/2 & C1/1	Battery	See 2
C215/2 & Ground	Battery	See 3
<ul style="list-style-type: none"> <li>If all voltages are correct, check wire from connector C215 to Radio for an open. If wire is OK, remove Radio for service.</li> </ul> <ol style="list-style-type: none"> <li>Check power input wire for an open.</li> <li>Check ground wire for an open to ground. Make sure ground G200 is clean and tight.</li> <li>Check memory power supply wire for an open.</li> </ol>		

**B: AMPLIFIER POWER TEST**

<b>Measure: VOLTAGE</b>		
<b>At: AMPLIFIER CONNECTOR (Disconnected)</b>		
<b>Conditions:</b>		
• Ignition Switch: RUN		
• Radio: ON		
Measure Between	Correct Voltage	For Diagnosis
11 & Ground	Battery	See 1
11 & 18	Battery	See 2
13 & Ground	Battery	See 3
11 & 10	Battery	See 4
<ul style="list-style-type: none"> <li>If all voltages are correct, go to Test C.</li> </ul> <ol style="list-style-type: none"> <li>Check power supply wire for an open.</li> <li>Check Amplifier ground to Amplifier for an open to ground. Make sure ground G200 is clean and tight.</li> <li>Check Amplifier "Radio On" wire for an open.</li> <li>Check wire from terminal 10 for an open to ground. Make sure ground G302 is clean and tight.</li> </ol>		

**C: FADER SIGNAL TEST (TABLE 1)**

<b>Measure: VOLTAGE</b>		
<b>At: FADER CONTROL CONNECTOR (Disconnected)</b>		
<b>Conditions:</b>		
• Ignition Switch: RUN		
• Radio: ON		
Measure Between	Correct Voltage	For Diagnosis
3 & Ground	Approximately 6 Volts	See 1
6 & Ground	Approximately 6 Volts	See 2
<ul style="list-style-type: none"> <li>If both voltages are correct, check for AC voltage at Radio outputs with Radio tuned to a strong signal. If AC voltage is present, go to Table 2. Remove Radio for service if AC voltage is not present.</li> </ul> <ol style="list-style-type: none"> <li>Check wire from Left Channel on Radio for an open. If wire is good, remove Radio for service.</li> <li>Check wire from Right Channel on Radio for an open. If wire is good, remove Radio for service.</li> </ol>		

(Continued on next page)

## 6500A-2 RADIO/ANTENNA

(Continued from previous page)

### C: FADER SIGNAL TEST (TABLE 2)

Measure: VOLTAGE At: AMPLIFIER CONNECTOR (Disconnected) Conditions: • Ignition Switch: RUN • Radio: ON		
Measure Between	Correct Voltage	For Diagnosis
14 & Ground	Approximately 6 Volts	See 1
15 & Ground	Approximately 6 Volts	See 2
19 & Ground	Approximately 6 Volts	See 3
20 & Ground	Approximately 6 Volts	See 4

- If all voltages are correct but sound was not present, remove Amplifier for service.

- Check between pin 2 (Fader) to pin 14 (Amplifier) for an open in the wiring. If wire is OK, replace Fader Control.
- Check between pin 4 (Fader) to pin 15 (Amplifier) for an open in the wiring. If wire is OK, replace Fader Control.
- Check between pin 5 (Fader) to pin 19 (Amplifier) for an open in the wiring. If wire is OK, replace Fader Control.
- Check between pin 7 (Fader) to pin 20 (Amplifier) for an open in the wiring. If wire is OK, replace Fader Control.

### D: SUSPECT SPEAKER TEST

Connect: OHMMETER At: SUSPECT SPEAKER (Disconnected) Condition: • Ohmmeter set on Rx 1 scale or Diode Check Scale		
Action	Correct Result	For Diagnosis
Connect Ohmmeter across Speaker Terminals	Speaker "pops"	See 1

- If the result is correct, check wires to the Amplifier for opens or shorts. If wires are OK, check the related wire between Fader and Amplifier.

- Replace the suspect Speaker.

### E: NOISE DIAGNOSIS

- With Radio on and noise present, unplug the Antenna at the back of the Radio.
- If noise is no longer present, it was being picked up by the Antenna. Perform Antenna Noise Test.
  - If noise persists, it is coming in the Radio wiring. Refer to the following Noise Symptom Table.

### ANTENNA NOISE TEST

Measure: RESISTANCE At: ANTENNA		
Measure Between	Correct Resistance	For Diagnosis
Antenna Plug Base & Ground	Less than 3 Ohms	See 1
Antenna Plug Tip & Antenna Plug Base	Greater than 1 Megaohm (open circuit)	See 2

- If both resistances are correct, check the hood ground strap. If hood ground strap is OK, substitute a different Antenna at Radio. If the new Antenna is good, replace Antenna. If noise is still present, refer to Noise Symptom Table.

- Check ground contact at Antenna base. If necessary, install a braided ground strap from the Antenna Base to Chassis ground. Check for an open in the Antenna Cable.
- Check for a short to ground at the Antenna or Antenna cable.

**NOISE SYMPTOM TABLE**

SYMPTOM	POSSIBLE CAUSE	REPAIR ACTION
Harsh popping or crackling noise present when ignition on-changes with engine rpm.	Ignition Noise	<ul style="list-style-type: none"> <li>• Check for proper distributor cap shielding.</li> <li>• Check shielding ground strap. If not present, install.</li> <li>• Check for defective spark plug or spark plug wire.</li> <li>• Reroute spark plug wires laying against anything that could be transmitting noise to the Radio (wiring or sensor leads traveling into the passenger compartment).</li> <li>• Check engine/firewall ground strap and engine hood/body ground strap.</li> <li>• Check if engine hood is closing properly.</li> <li>• Connect dedicated ground strap to Radio.</li> <li>• Replace distributor cap and rotor.</li> </ul>
High whine or howling that changes with engine rpm.	Alternator noise	<ul style="list-style-type: none"> <li>• Connect dedicated ground strap to Radio.</li> <li>• Run a direct wire from Battery to Alternator.</li> </ul>
AM only is weak and noisy.	AM alignment	<ul style="list-style-type: none"> <li>• Remove Radio for service.</li> </ul>
FM only is weak and noisy.	FM alignment	<ul style="list-style-type: none"> <li>• Remove Radio for service.</li> </ul>

# 6571-0 CRUISE CONTROL

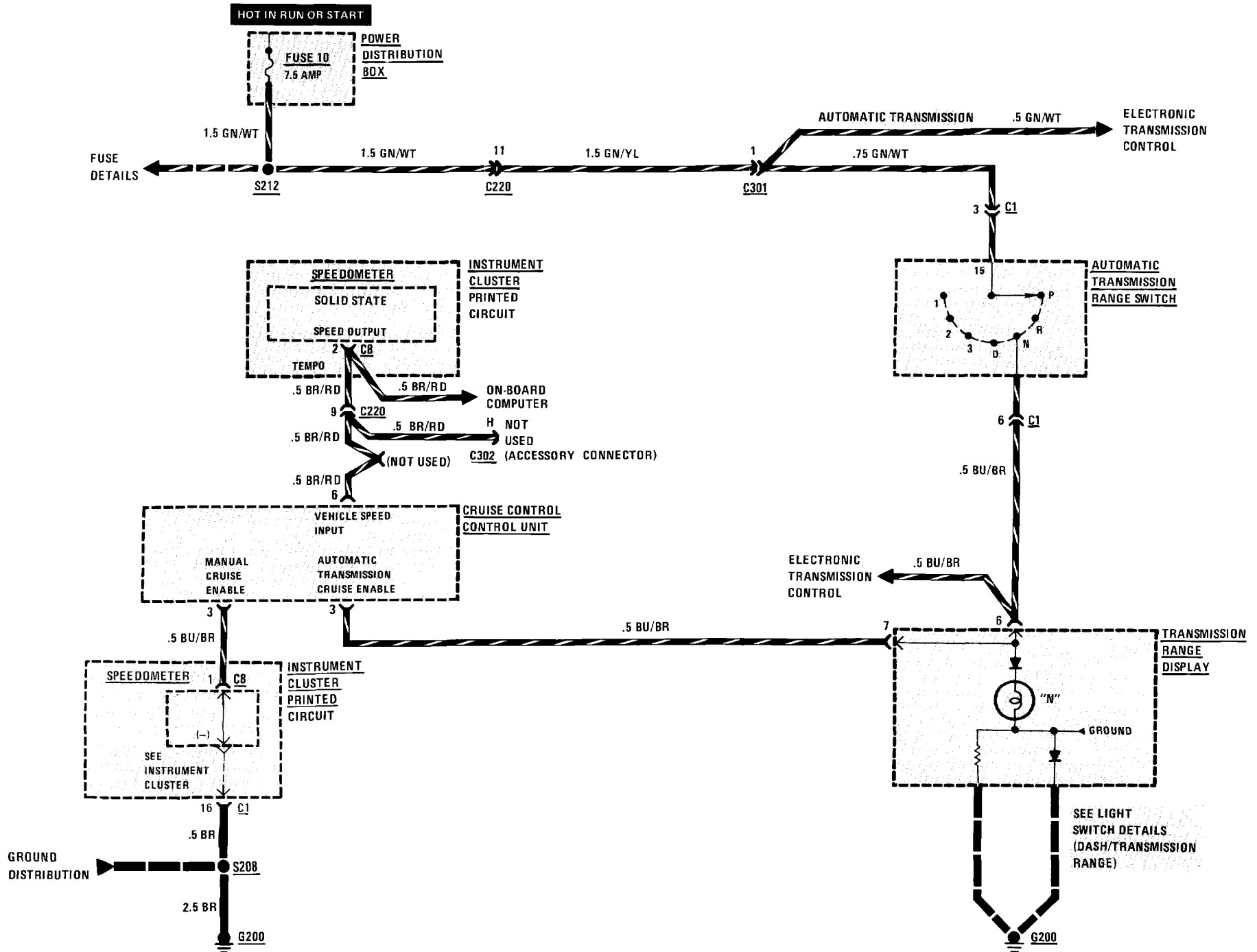

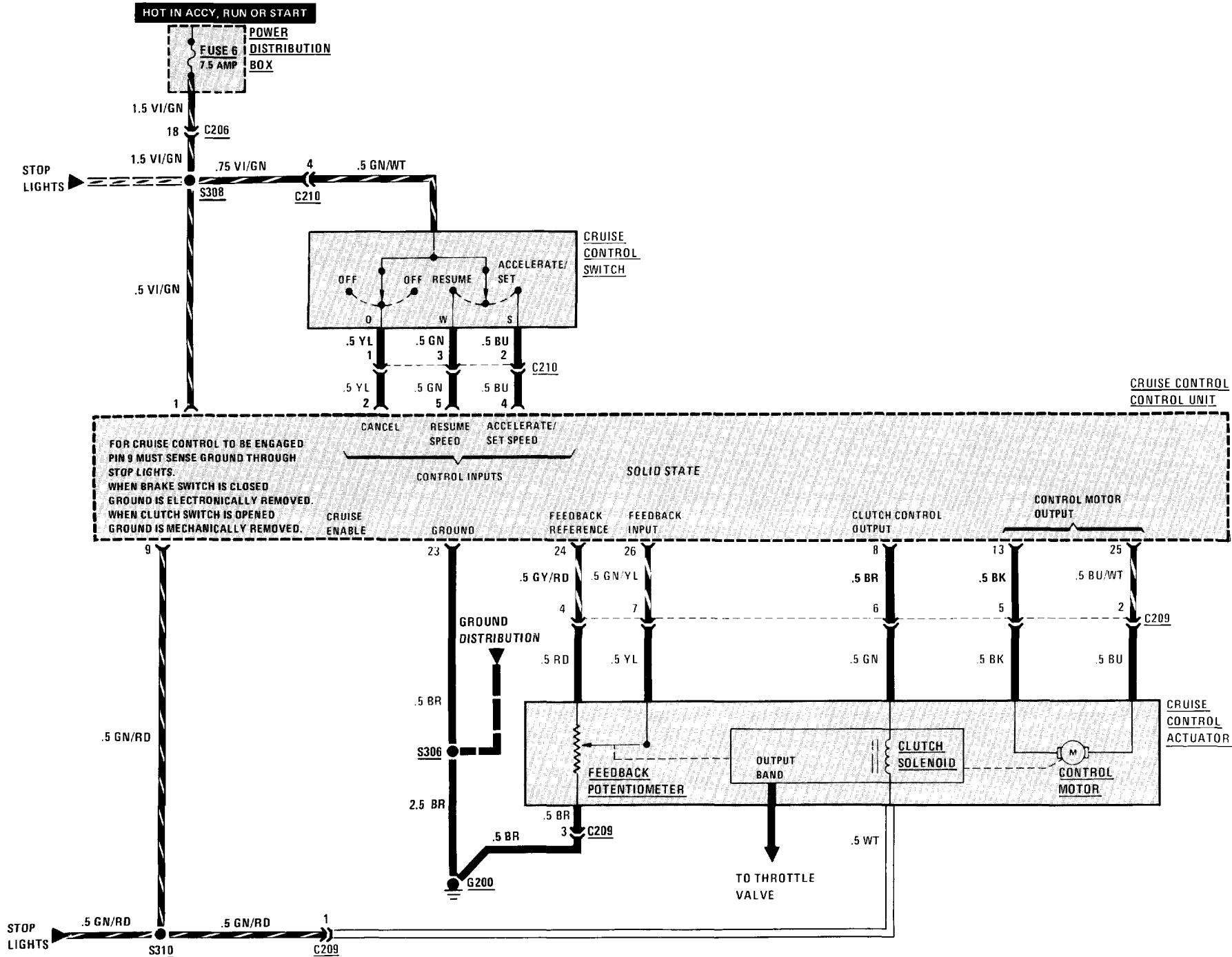

# 6581-0 ON-BOARD COMPUTER

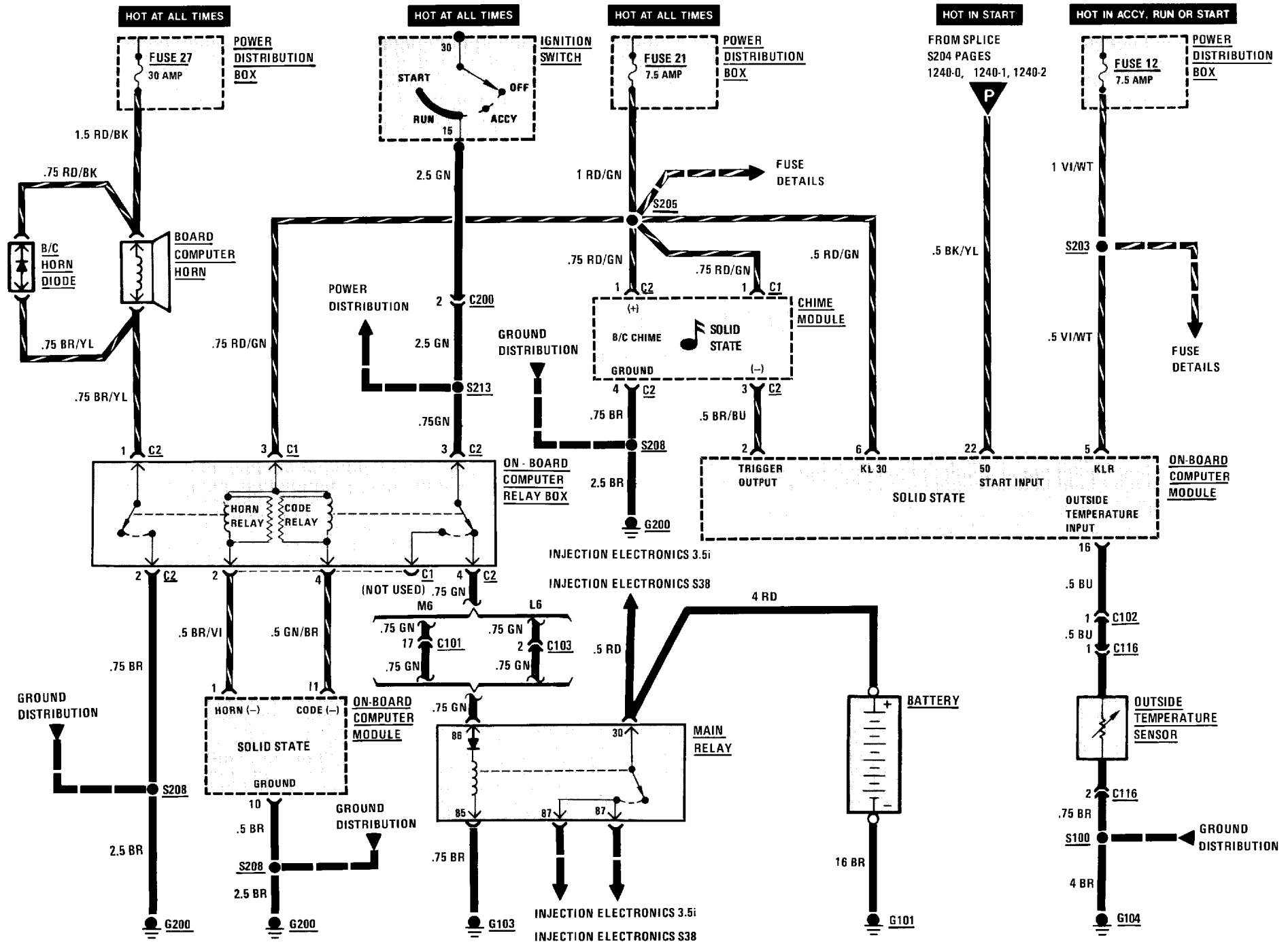



# 6581-2 ON-BOARD COMPUTER M6

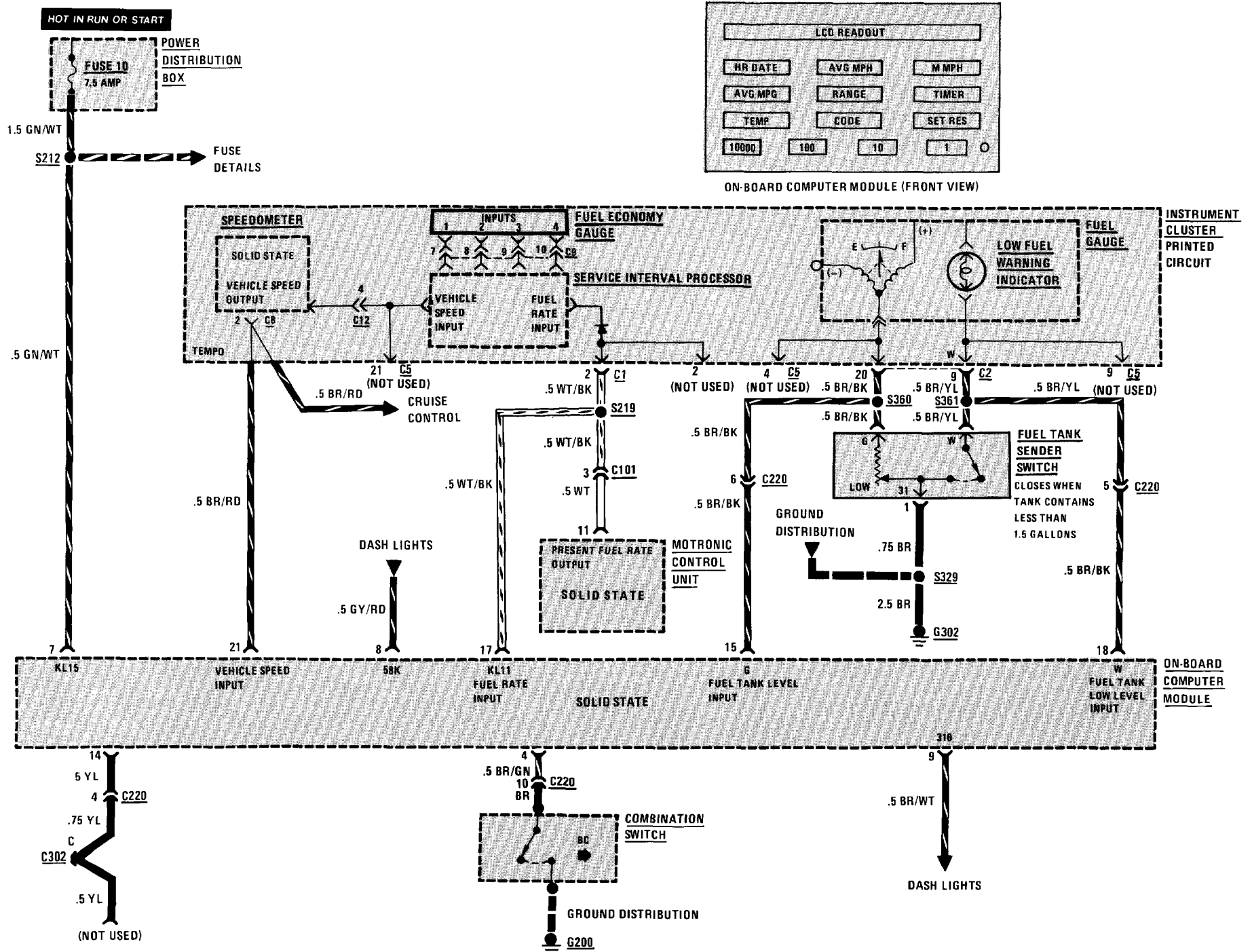



## 7000-0 COMPONENT LOCATION VIEWS

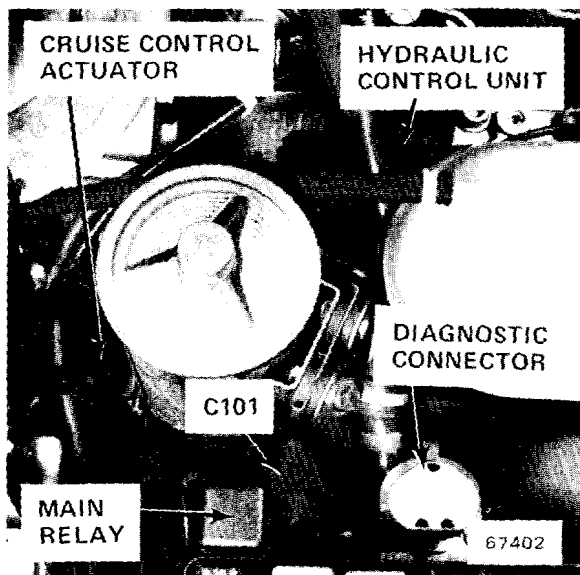

Figure 1 - Right Of LH Front Wheel Well

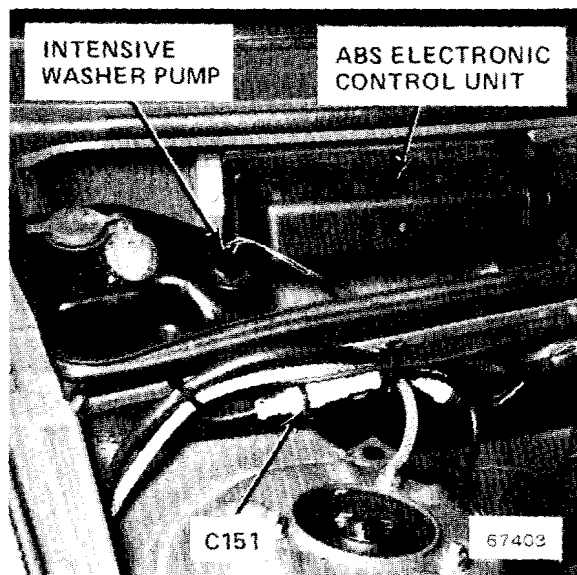

Figure 3 - RH Rear Corner Of Engine Compartment

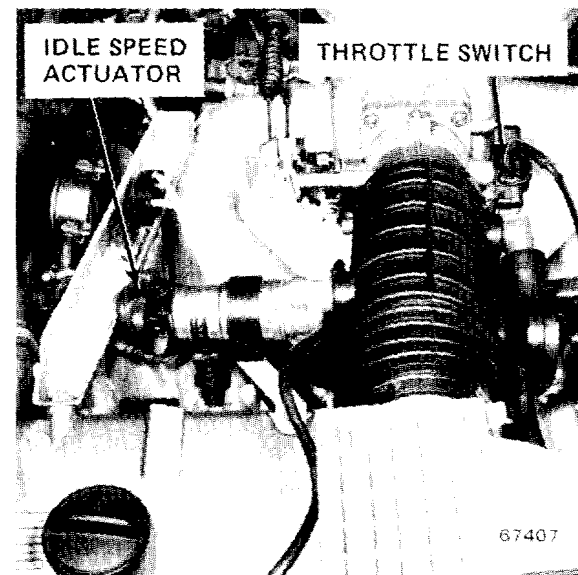

Figure 5 - Top Center Of Engine

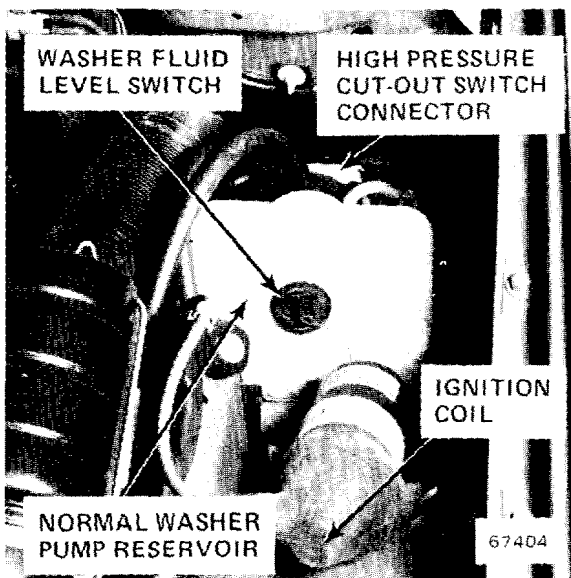

Figure 2 - Ahead Of RH Front Wheel Well

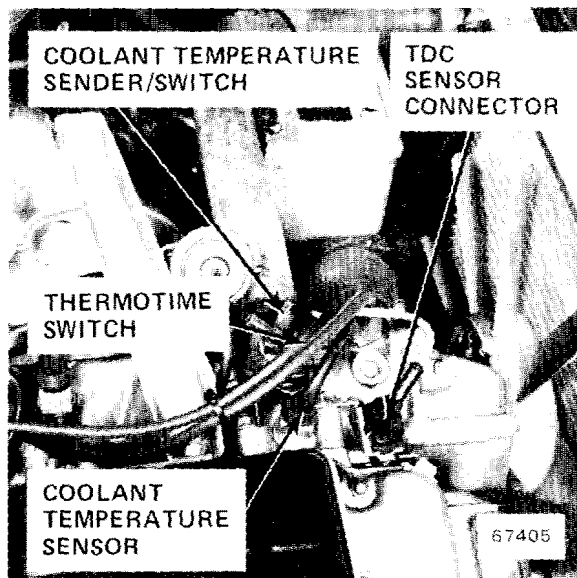

Figure 4 - Top Front Of Engine

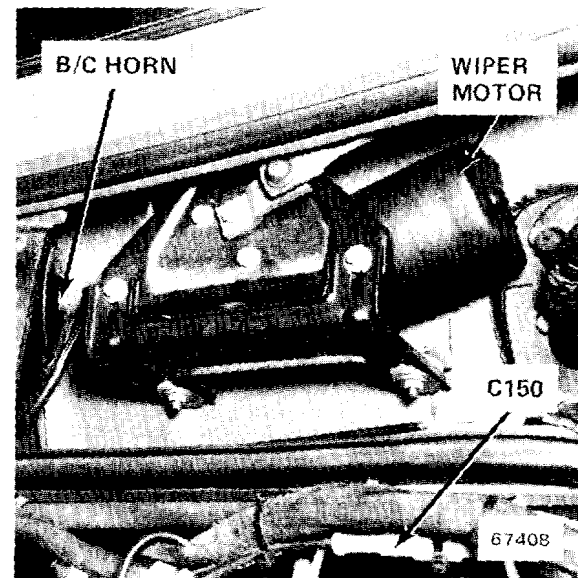

Figure 6 - Under LH Side Of Cowl

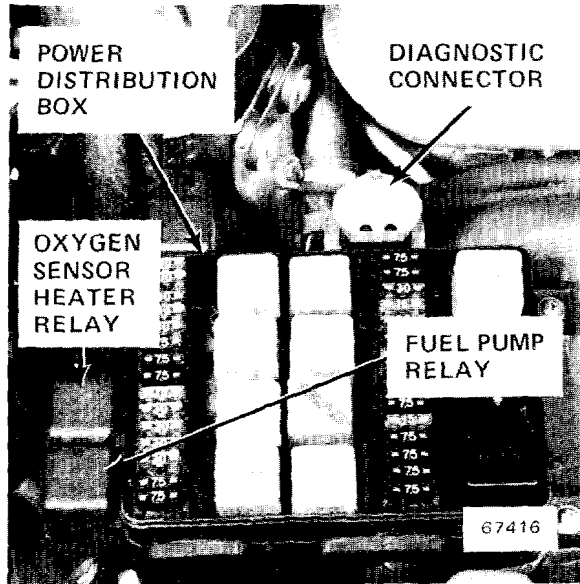

Figure 1 - Top of LH Front Wheel Well

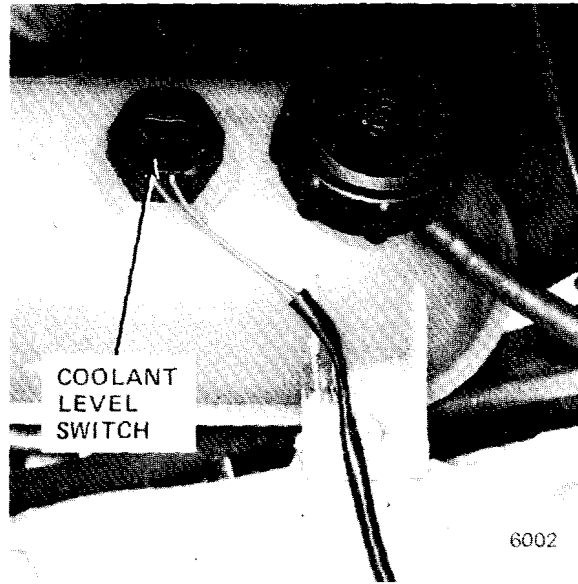

Figure 3 - Right of LH Front Wheel Well

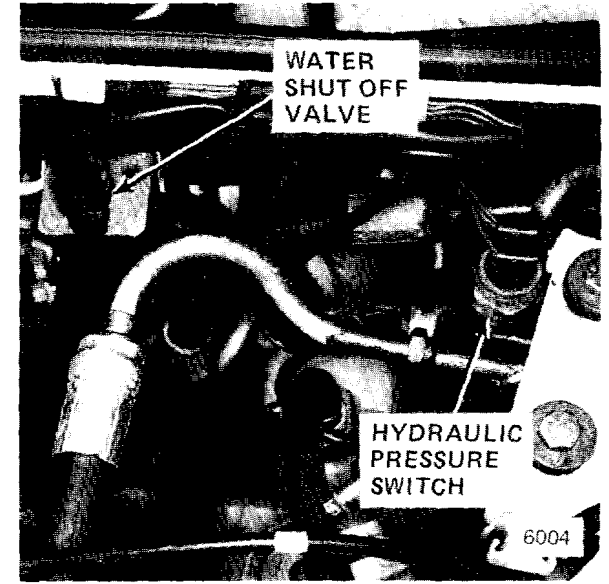

Figure 5 - LH Rear Corner of Engine Compartment

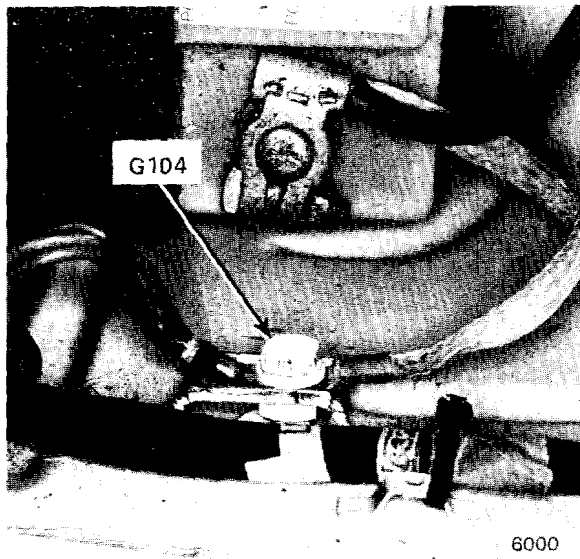

Figure 2 - Inner Fender, Left of Battery

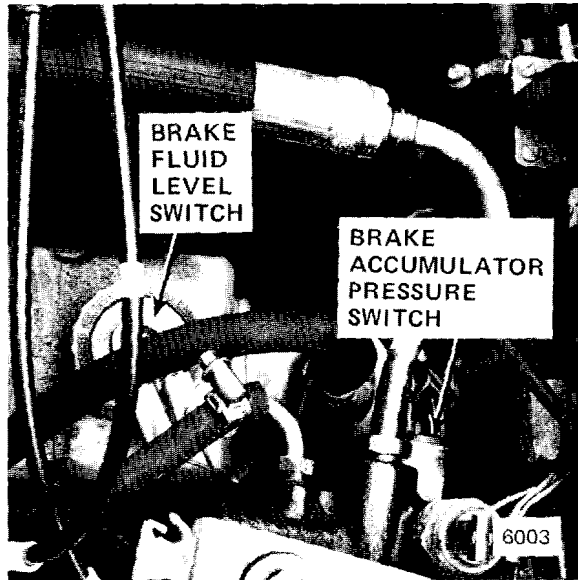

Figure 4 - LH Rear Corner of Engine Compartment

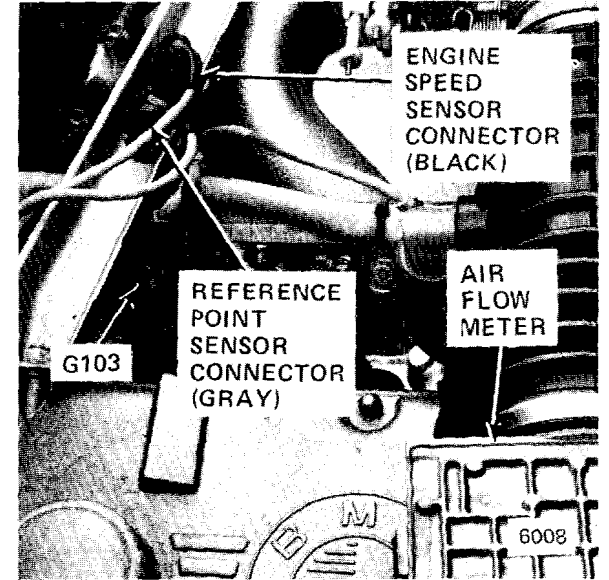

Figure 6 - Top Rear of Engine

## 7000-2 COMPONENT LOCATION VIEWS

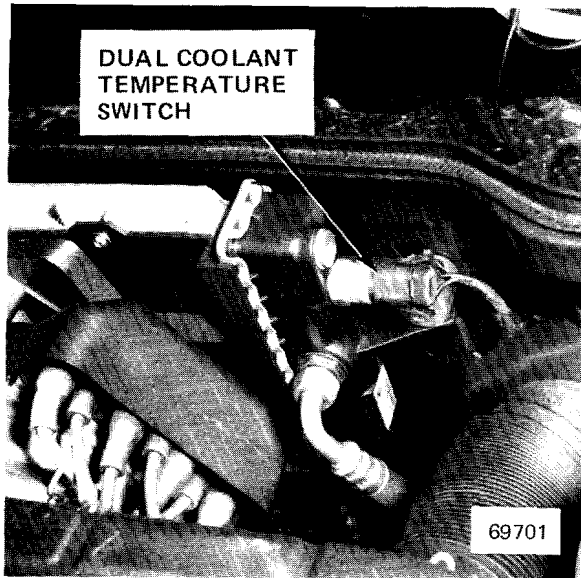

Figure 1 - Top RH Side of Radiator

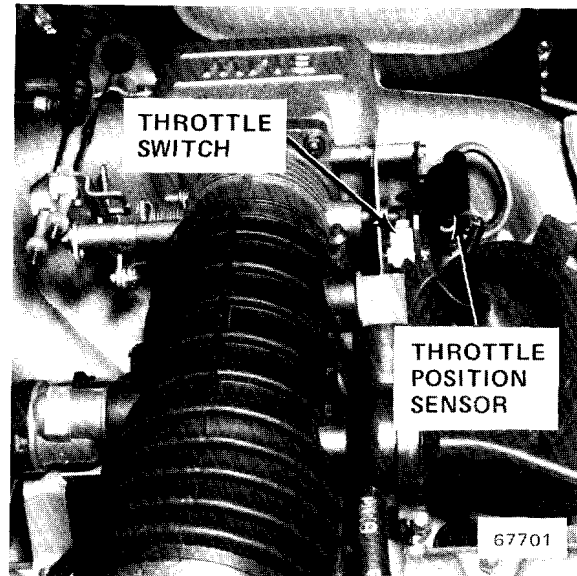

Figure 3 - Top Center of Engine

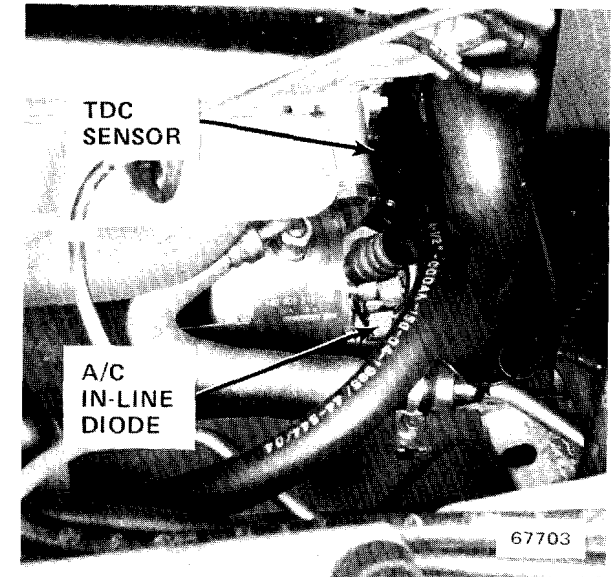

Figure 5 - RH Front of Engine

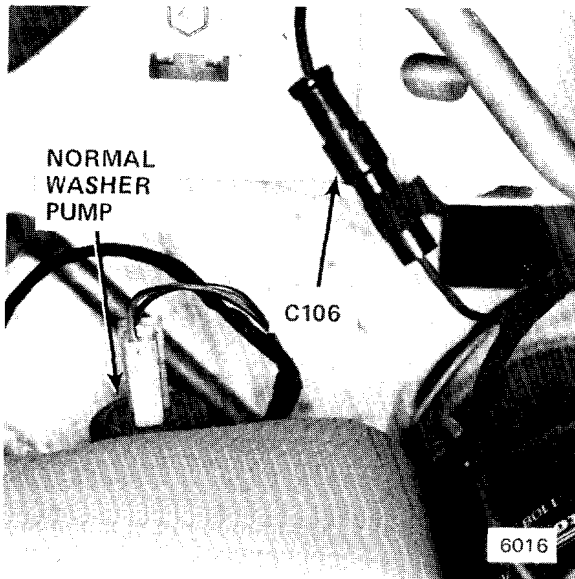

Figure 2 - Ahead Of RH Front Wheel Well



Figure 4 - Rear of Engine

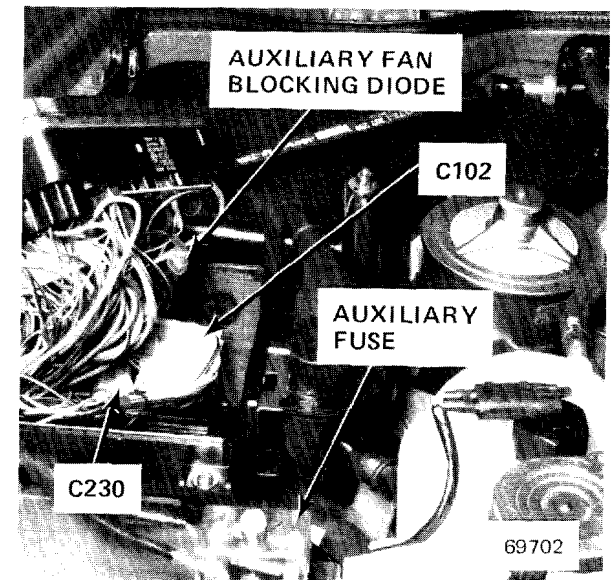

Figure 6 - LH Side Of Engine Compartment

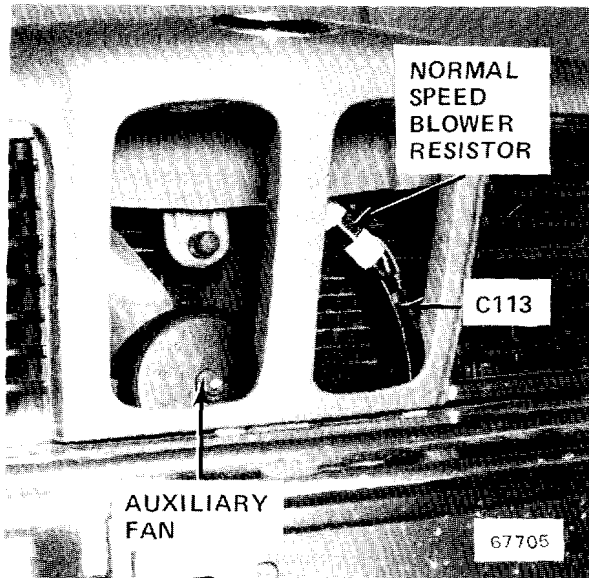

Figure 1 - Front of Car  
(Center Grills Removed)

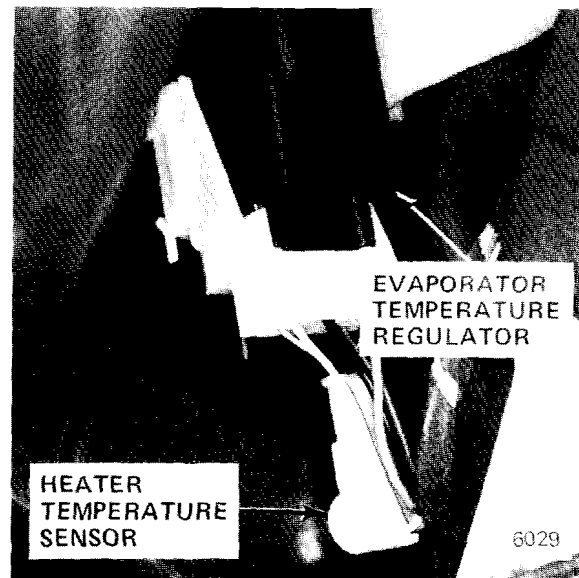

Figure 3 - Behind LH Side of Console

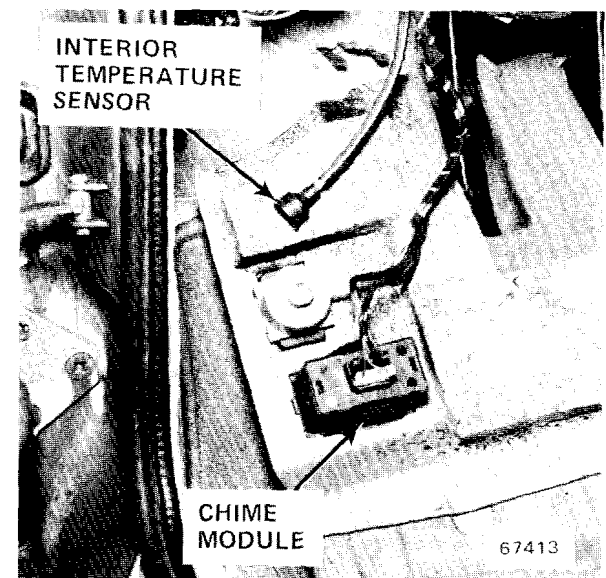

Figure 5 - Behind Dash, Left of Steering Column

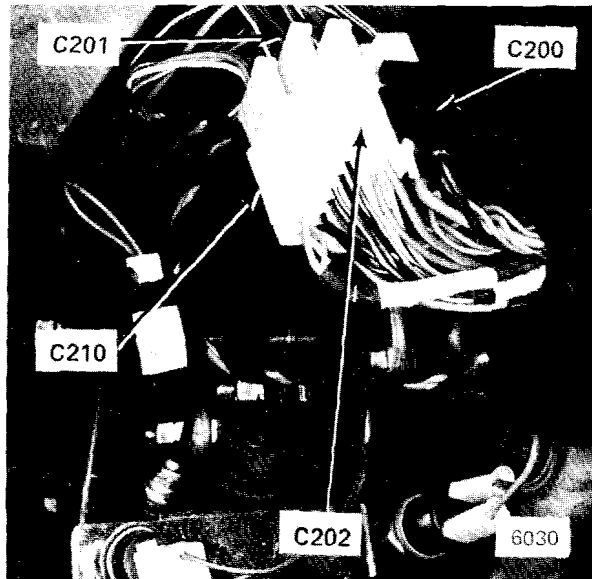

Figure 2 - Driver's Footwell, Above Brake Pedal

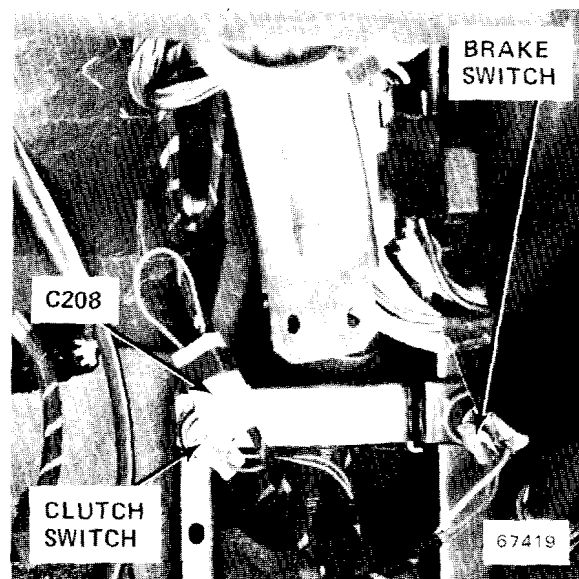

Figure 4 - Driver's Footwell, Above Brake Pedal

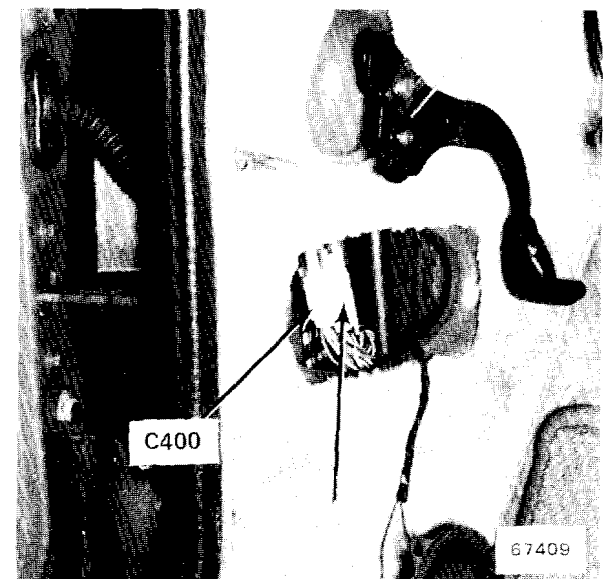

Figure 6 - LH Front Kick Panel

# 7000-4 COMPONENT LOCATION VIEWS

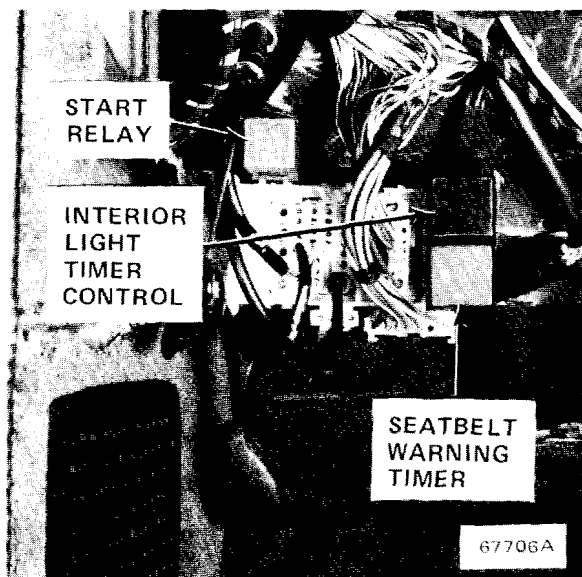

Figure 1 - Near LH Front Kick Panel

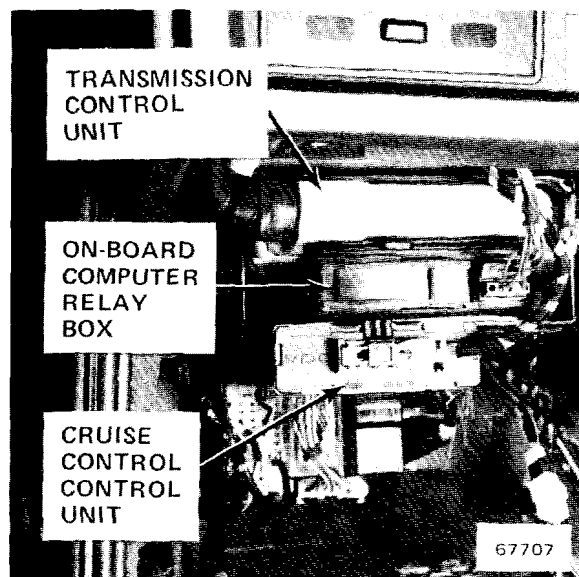

Figure 3 - Above LH Front Kick Panel

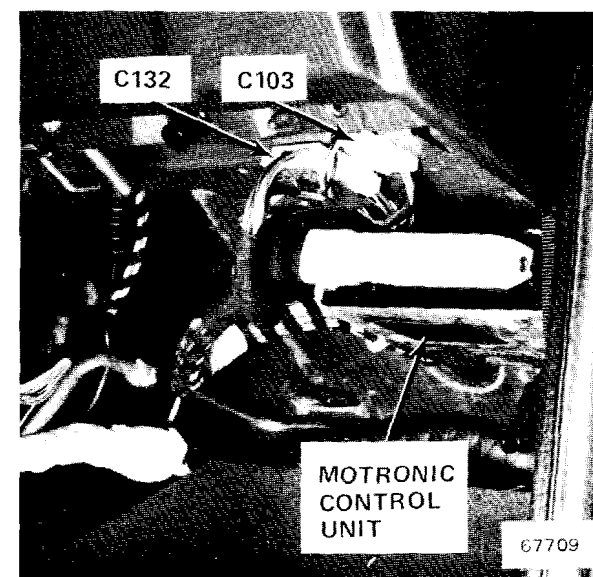

Figure 5 - Above Glove Box



Figure 2 - Near LH Front Kick Panel

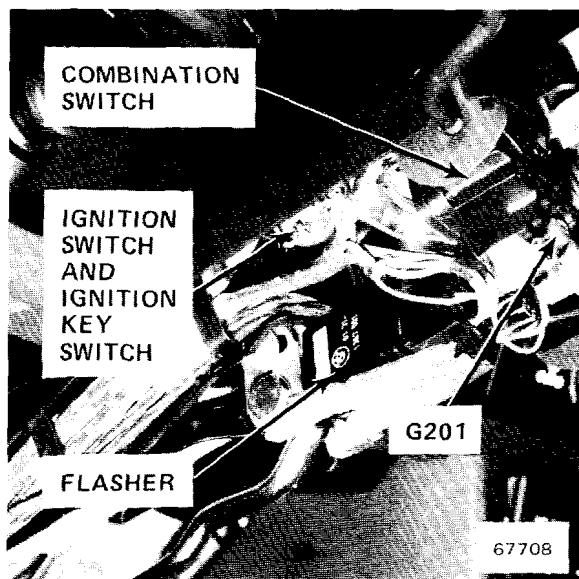

Figure 4 - Underside of Steering Column

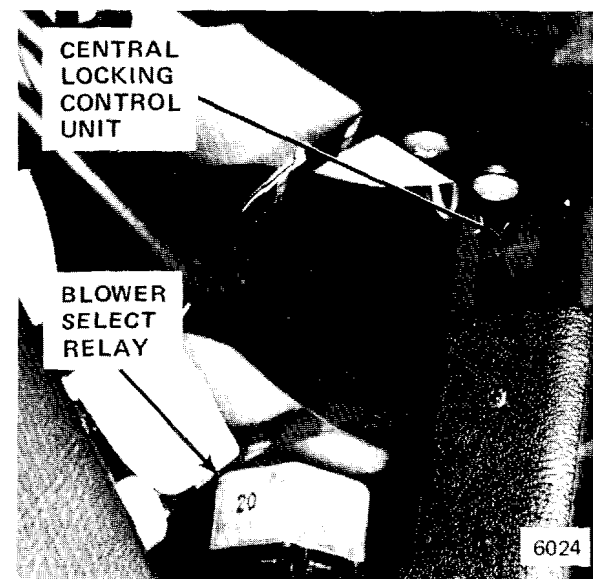

Figure 6 - Behind Dash, Left of Glove Box



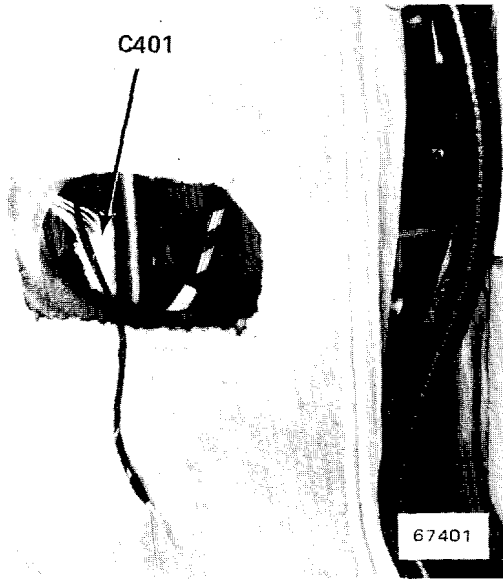

Figure 1 - RH Front Kick Panel

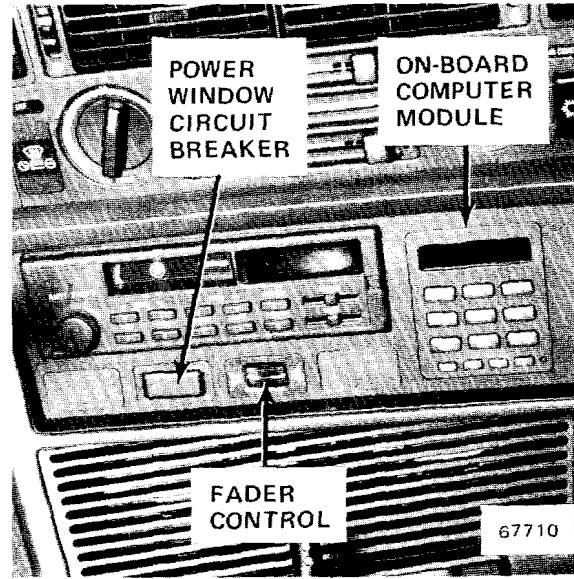

Figure 3 - Center Console

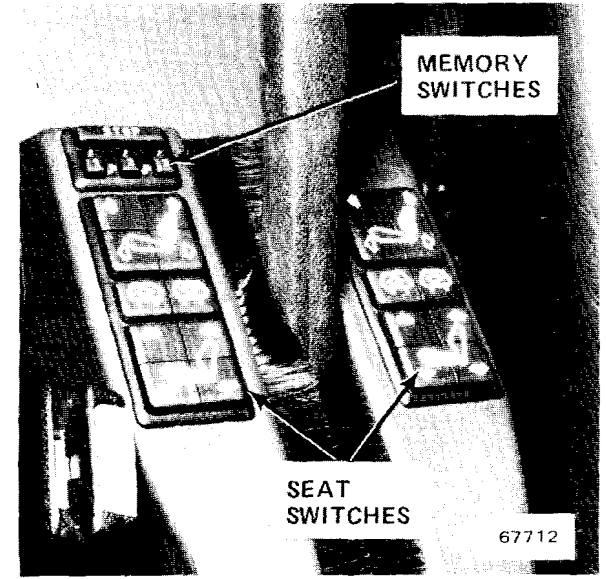

Figure 5 - Center Console

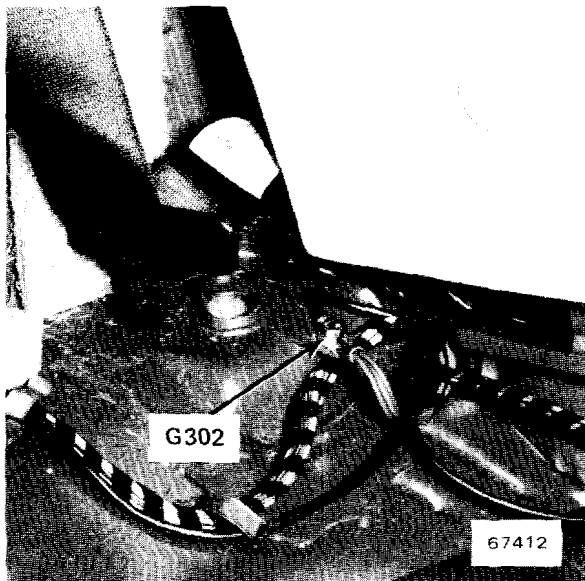

Figure 2 - Under LH Side of Rear Seat

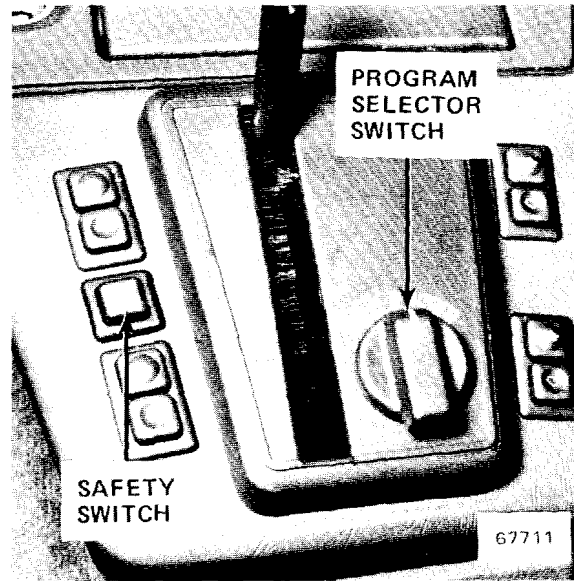

Figure 4 - Center Console

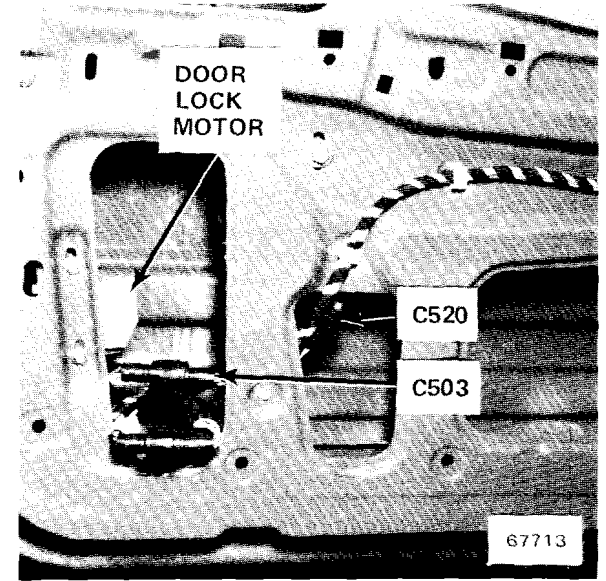

Figure 6 - Inside Driver's Door

# 7000-6 COMPONENT LOCATION VIEWS

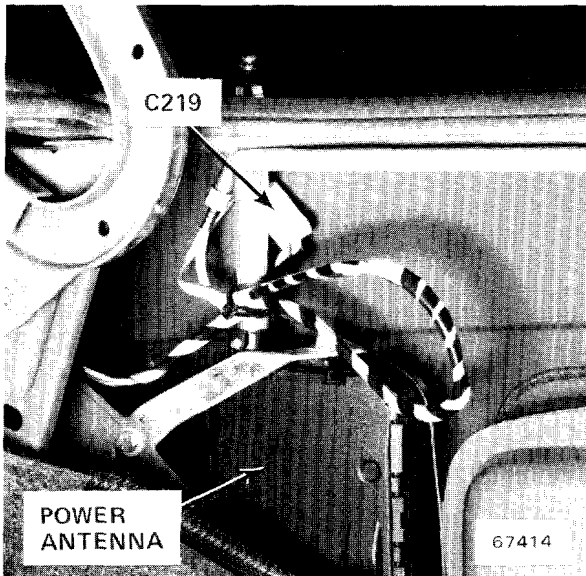

Figure 1 - RH Side of Trunk

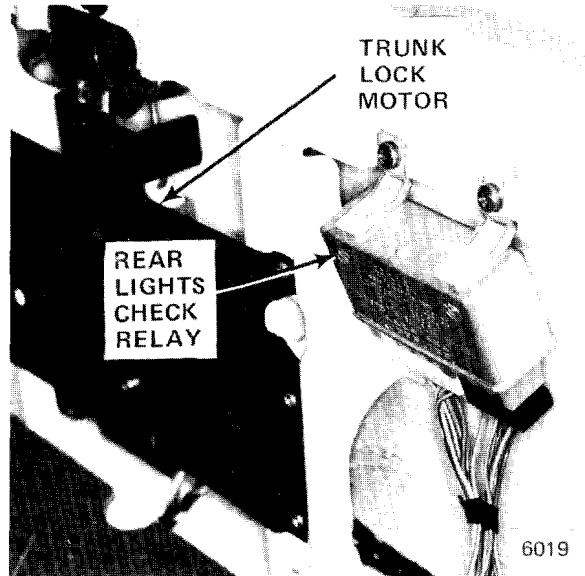

Figure 3 - Rear Panel of Trunk

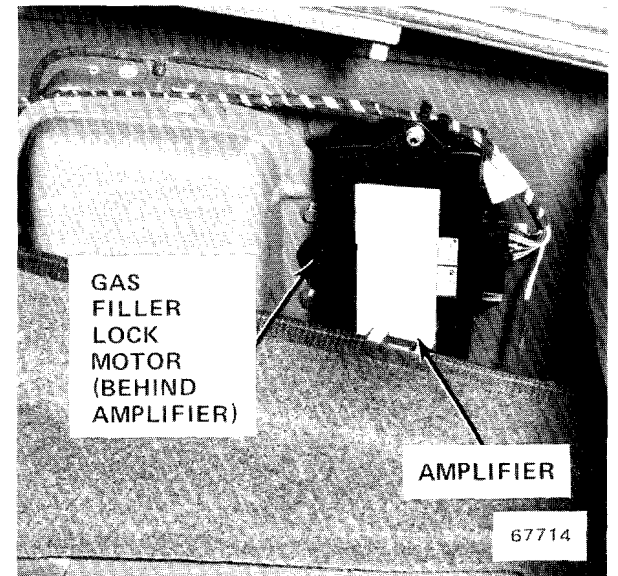

Figure 5 - RH Side of Trunk

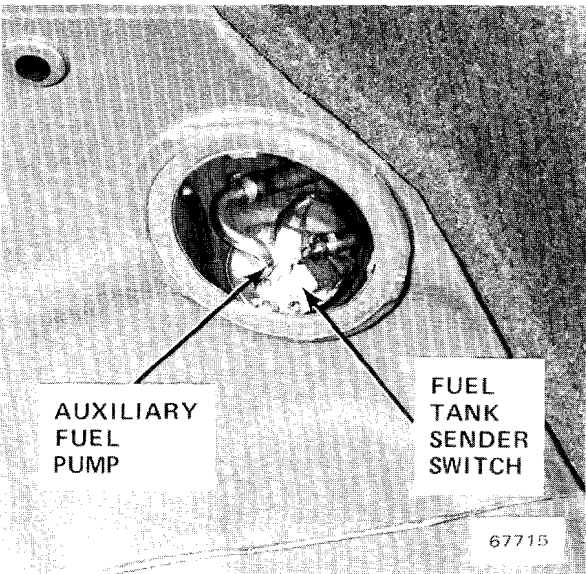

Figure 2 - RH Side of Trunk Floor



Figure 4 - LH Trunk Hinge

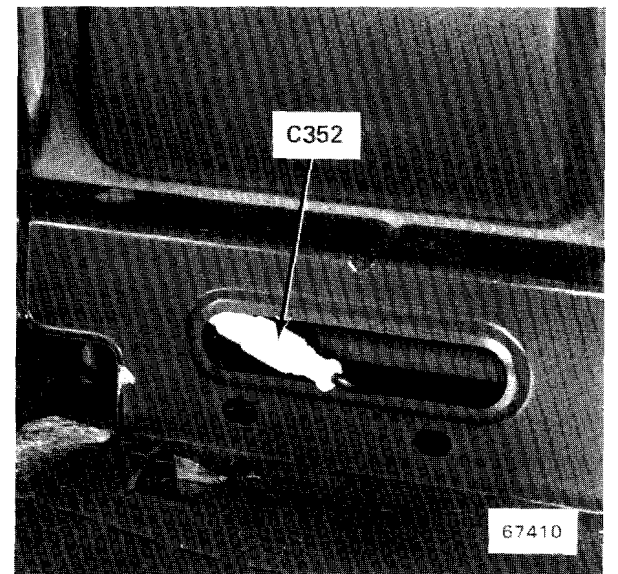

Figure 6 - LH Front of Trunk

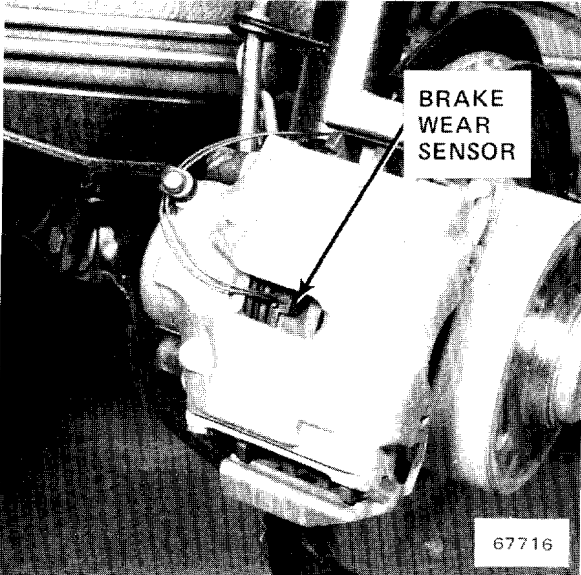

Figure 1 - LH Front Brake Assembly (RH Rear Similar)

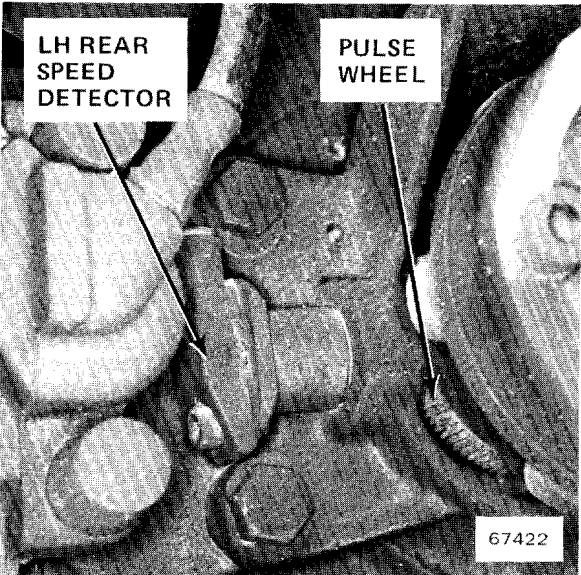

Figure 3 - Back of LH Rear Wheel

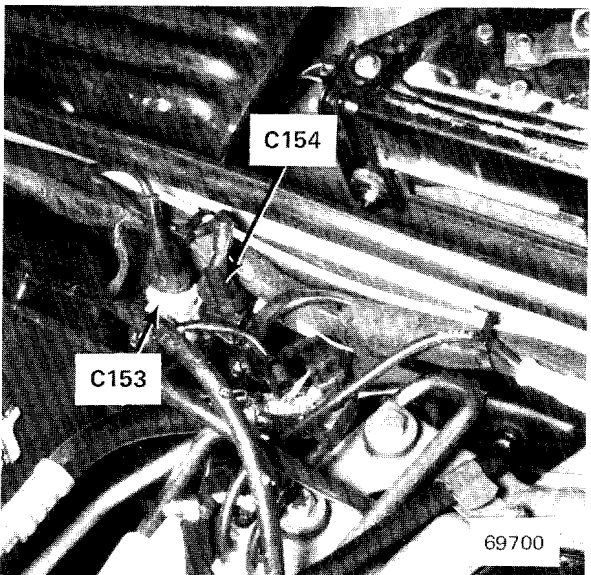

Figure 5 - Center Rear Of S38 Engine Compartment

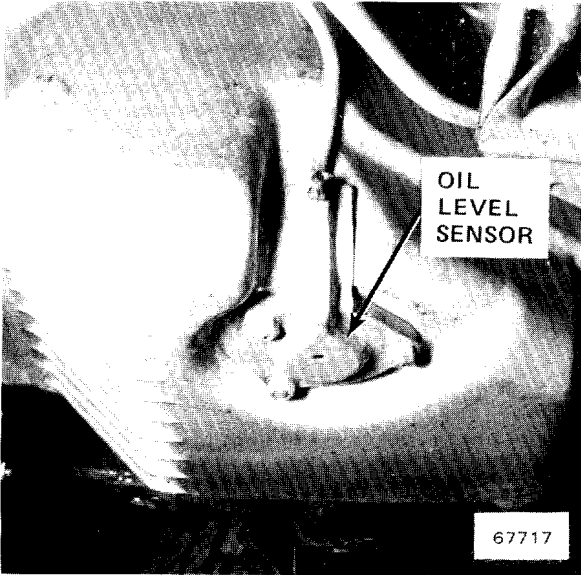

Figure 2 - Bottom of Oil Pan

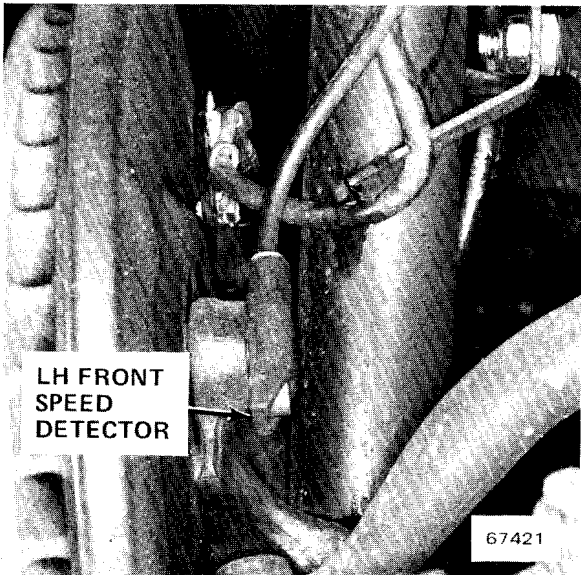

Figure 4 - Back of LH Front Wheel

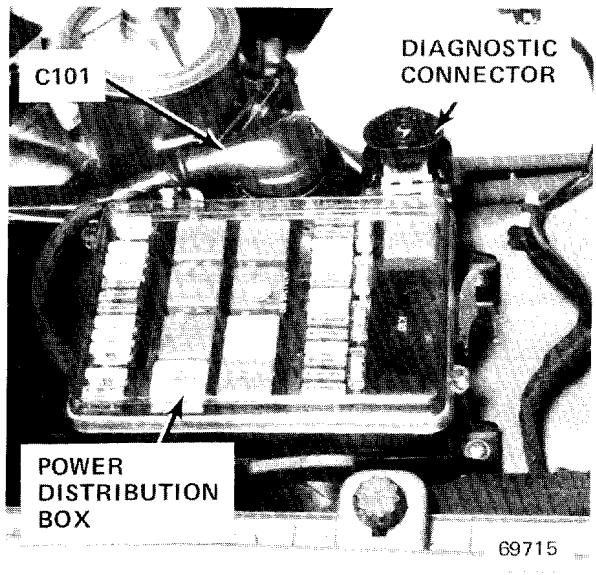

Figure 6 - LH Side Of S38 Engine Compartment



# 7000-8 COMPONENT LOCATION VIEWS

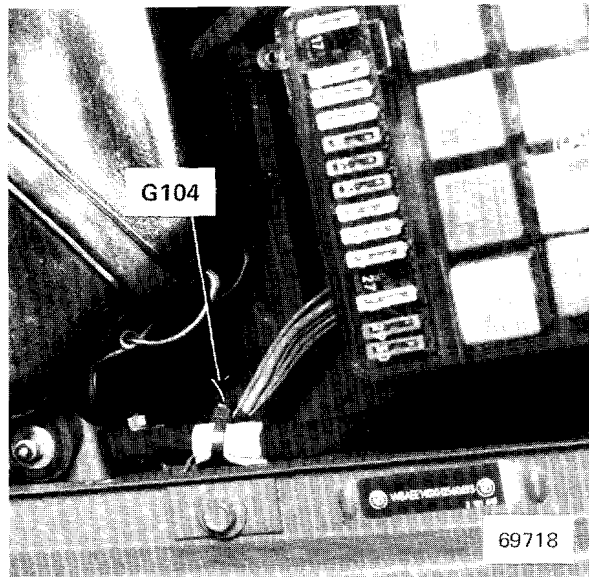

Figure 1 - LH Side Of S38 Engine Compartment

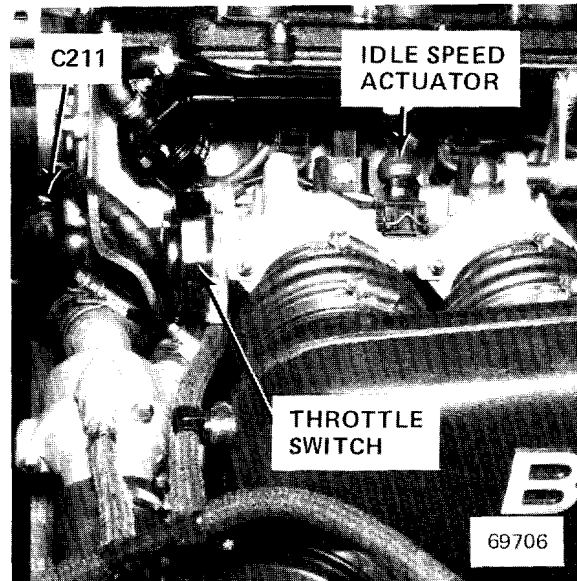

Figure 3 - LH Front Of S38 Engine

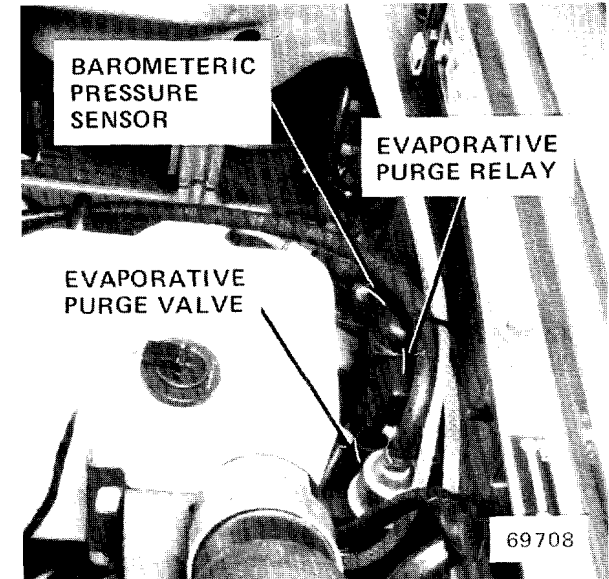

Figure 5 - RH Front Corner Of S38 Engine Compartment

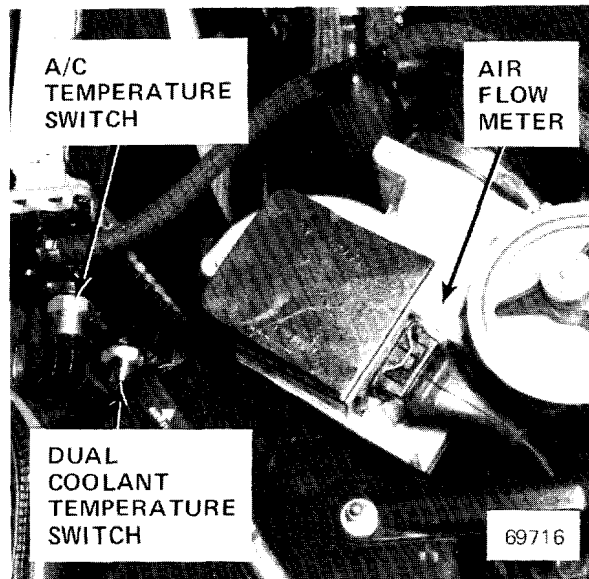

Figure 2 - LH Front Corner of S38 Engine Compartment

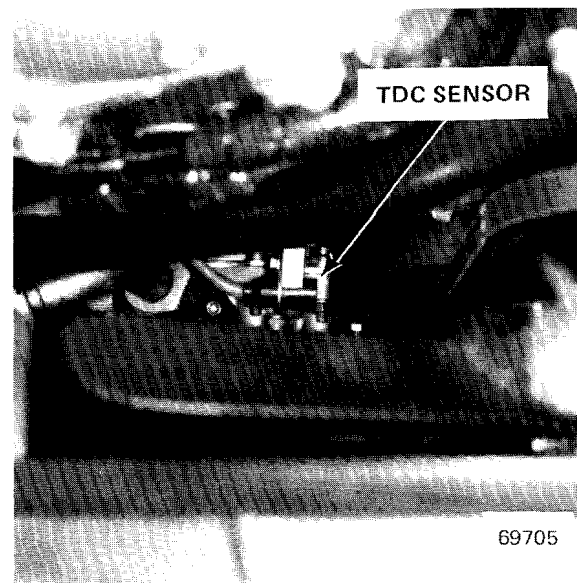

Figure 4 - LH Front Of S38 Engine Compartment

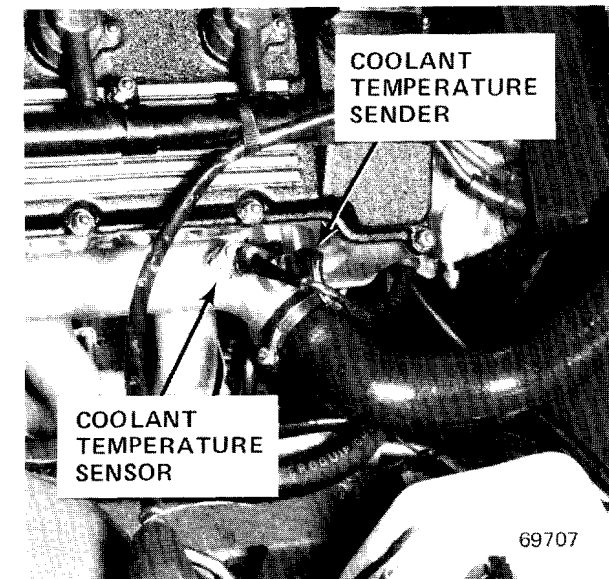

Figure 6 - RH Front Of S38 Engine Compartment

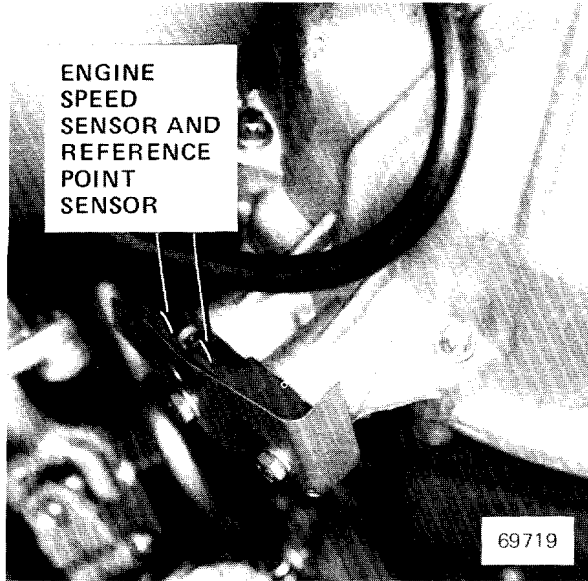

Figure 1 - Underside Of Car, LH Side Of Transmission Bell Housing (M6)

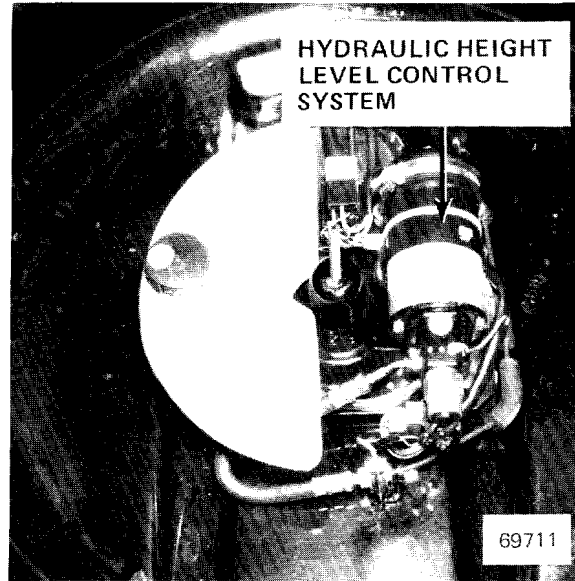

Figure 3 - Underside Of Car, Forward Of Rear Axle (M6)

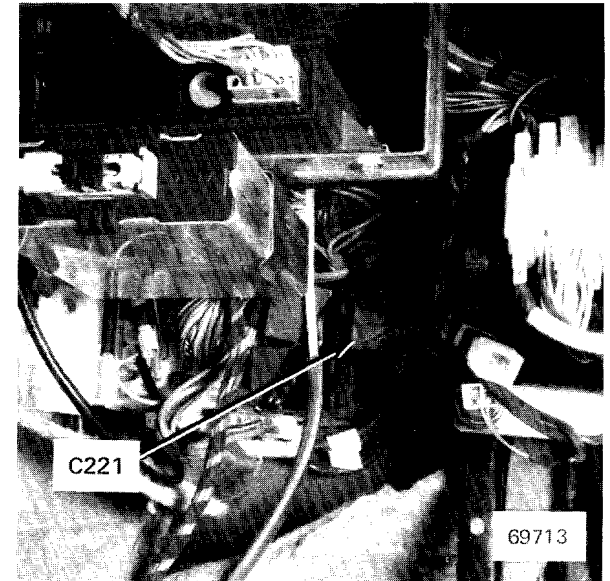

Figure 5 - Driver's Footwell, Above Clutch Pedal (M6)



Figure 2 - Bottom Of M6 Trunk

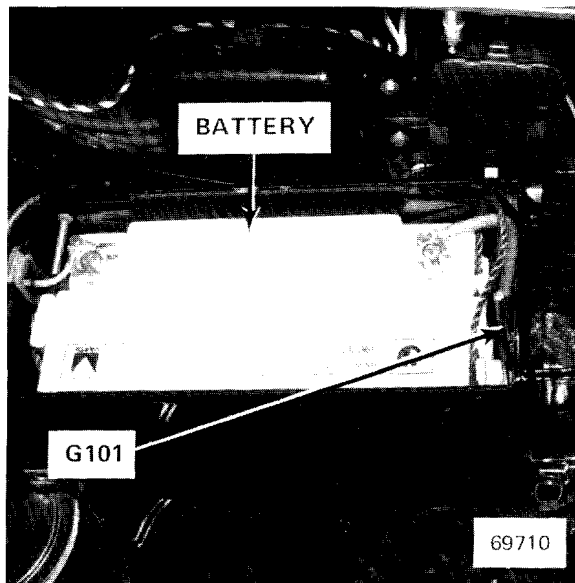

Figure 4 - RH Rear Corner Of M6 Trunk

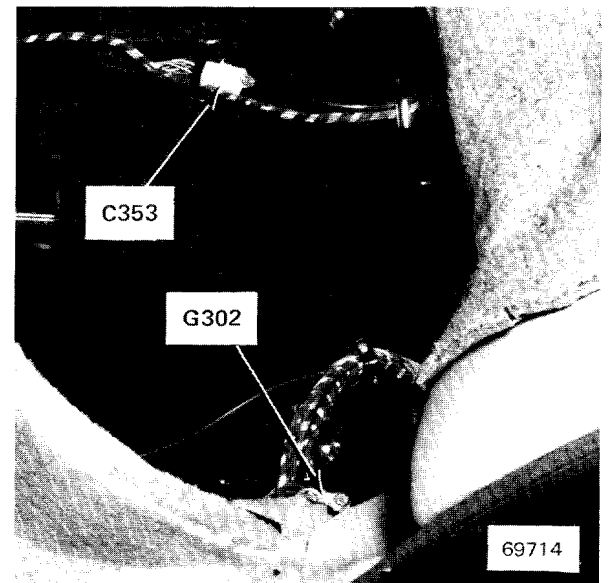

Figure 6 - Under LH Side Of Rear Seat (M6)

## 7000-10 COMPONENT LOCATION VIEWS

---

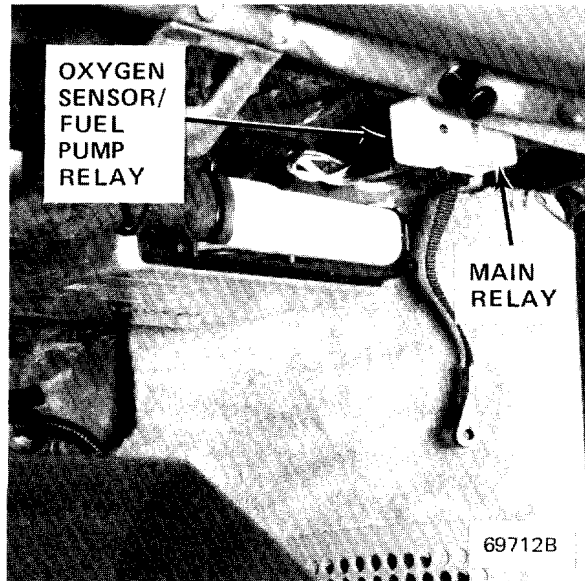

Figure 1 - Under RH Side Of Dash (M6)



Figure 2 - Under RH Side Of Dash (M6)

## 8000-0 SPLICE LOCATION VIEWS

### SPLICE LOCATION INDEX

This index contains all the splices in the car, what harness each one is in, and the page that the splices appear on. The drawings after the index show how the harness is routed through the car and where the splices are located on the harness.

SPLICE	HARNESS	PAGE NUMBER	SPLICE	HARNESS	PAGE NUMBER
S100	FRONT	8000-2	S205	MIDDLE	8000-4
S100	FRONT (M6)	8000-3	S206	MIDDLE	8000-4
S101	FRONT	8000-2	S207	MIDDLE	8000-4
S101	FRONT (M6)	8000-3	S208	MIDDLE	8000-4
S102	FRONT	8000-2	S209	MIDDLE	8000-4
S102	FRONT (M6)	8000-3	S210	MIDDLE	8000-4
S103	FRONT	8000-2	S211	MIDDLE	8000-4
S104	FRONT	8000-2	S212	MIDDLE	8000-4
S104	FRONT (M6)	8000-3	S213	MIDDLE	8000-4
S105	ENGINE	8000-6	S214	MIDDLE	8000-4
S105	ENGINE (S38)	8000-7	S215	MIDDLE	8000-4
S106	ENGINE	8000-6	S216	MIDDLE	8000-4
S106	ENGINE (S38)	8000-7	S217	MIDDLE	8000-4
S107	ENGINE	8000-6	S219	MIDDLE	8000-4
S108	ENGINE (S38)	8000-7	S225	A/C	NOT SHOWN
S109	ENGINE	8000-6	S226	A/C	NOT SHOWN
S109	ENGINE (S38)	8000-7	S227	A/C	NOT SHOWN
S110	ENGINE	8000-6	S228	A/C	NOT SHOWN
S110	ENGINE (S38)	8000-7	S229	A/C	NOT SHOWN
S112	MIDDLE	8000-4	S230	A/C	NOT SHOWN
S113	MIDDLE	8000-4	S300	REAR	8000-5
S115	MIDDLE	8000-4	S301	REAR	8000-5
S116	MIDDLE	8000-4	S302	REAR	8000-5
S117	FRONT	8000-2	S303	REAR	8000-5
S117	FRONT	8000-3	S306	REAR	8000-5
S118	WASHER JETS	NOT SHOWN	S307	REAR	8000-5
S119	WASHER JETS	NOT SHOWN	S308	REAR	8000-5
S120	MIDDLE	8000-4	S309	REAR	8000-5
S121	ENGINE (S38)	8000-7	S310	REAR	8000-5
S151	MIDDLE	8000-4	S313	REAR	8000-5
S200	MIDDLE	8000-4	S314	REAR	8000-5
S201	MIDDLE	8000-4			
S202	MIDDLE	8000-4			
S203	MIDDLE	8000-4			
S204	MIDDLE	8000-4			

SPLICE LOCATION INDEX

SPLICE	HARNESS	PAGE NUMBER	SPLICE	HARNESS	PAGE NUMBER
S315	REAR	8000-5	S601	SUNROOF	NOT SHOWN
S316	REAR	8000-5	S602	REAR CONSOLE	NOT SHOWN
S319	REAR	8000-5	S603	REAR CONSOLE	NOT SHOWN
S320	REAR	8000-5	S604	REAR CONSOLE	NOT SHOWN
S321	REAR	8000-5	S900	BATTERY POSITIVE (M6)	8000-8
S322	REAR	8000-5			
S323	REAR	8000-5			
S324	REAR	8000-5			
S325	REAR	8000-5			
S326	REAR	8000-5			
S327	REAR	8000-5			
S328	REAR	8000-5			
S329	REAR	8000-5			
S330	REAR	8000-5			
S331	REAR	8000-5			
S332	REAR	8000-5			
S333	REAR	8000-5			
S334	REAR	8000-5			
S335	REAR	8000-5			
S336	REAR	8000-5			
S337	REAR	8000-5			
S338	REAR	8000-5			
S360	REAR	8000-5			
S361	REAR	8000-5			
S362	REAR	8000-5			
S370	SOUND SYSTEM	NOT SHOWN			
S409	DOOR	NOT SHOWN			
S502	DOOR	NOT SHOWN			
S550	POWER SEATS	NOT SHOWN			
S551	POWER SEATS	NOT SHOWN			
S552	BOLSTER SUPPORT	NOT SHOWN			
S553	BOLSTER SUPPORT	NOT SHOWN			
S600	SUNROOF	NOT SHOWN			

FRONT HARNESS

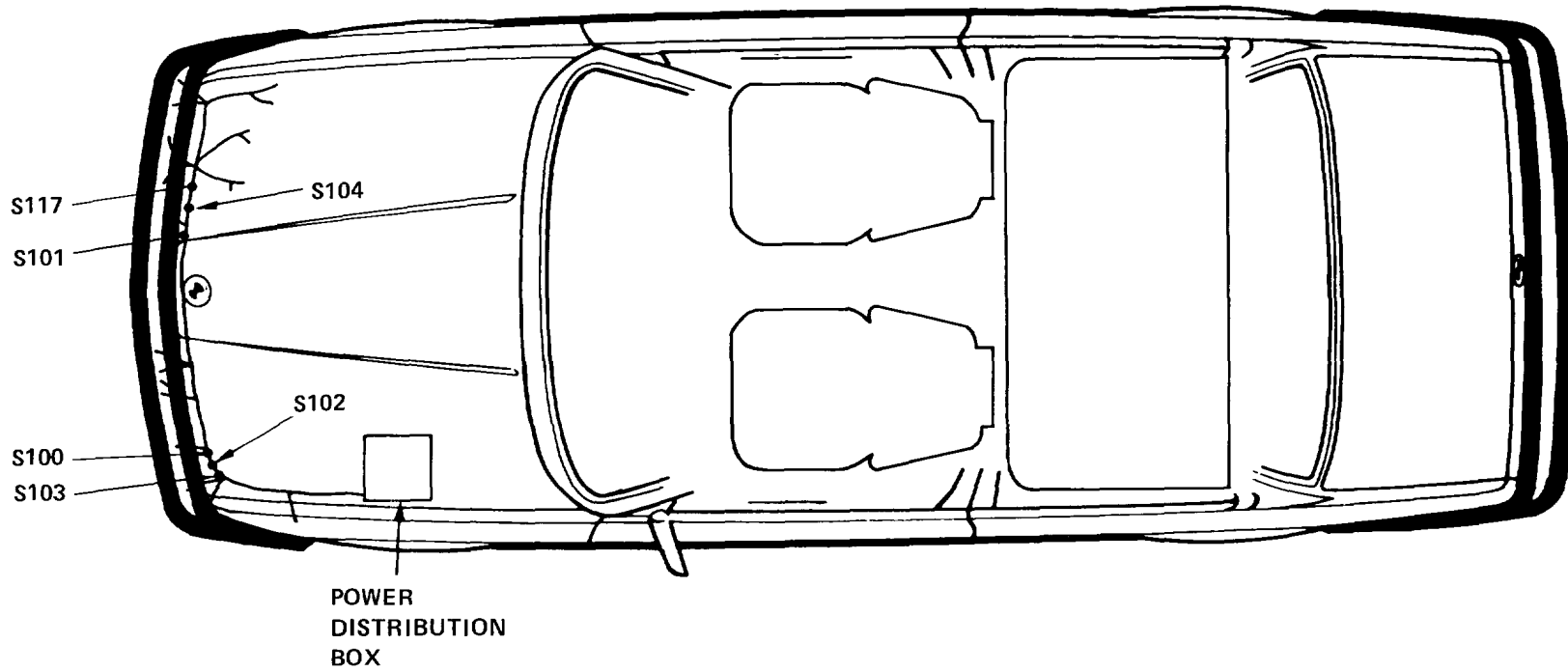

FRONT HARNESS

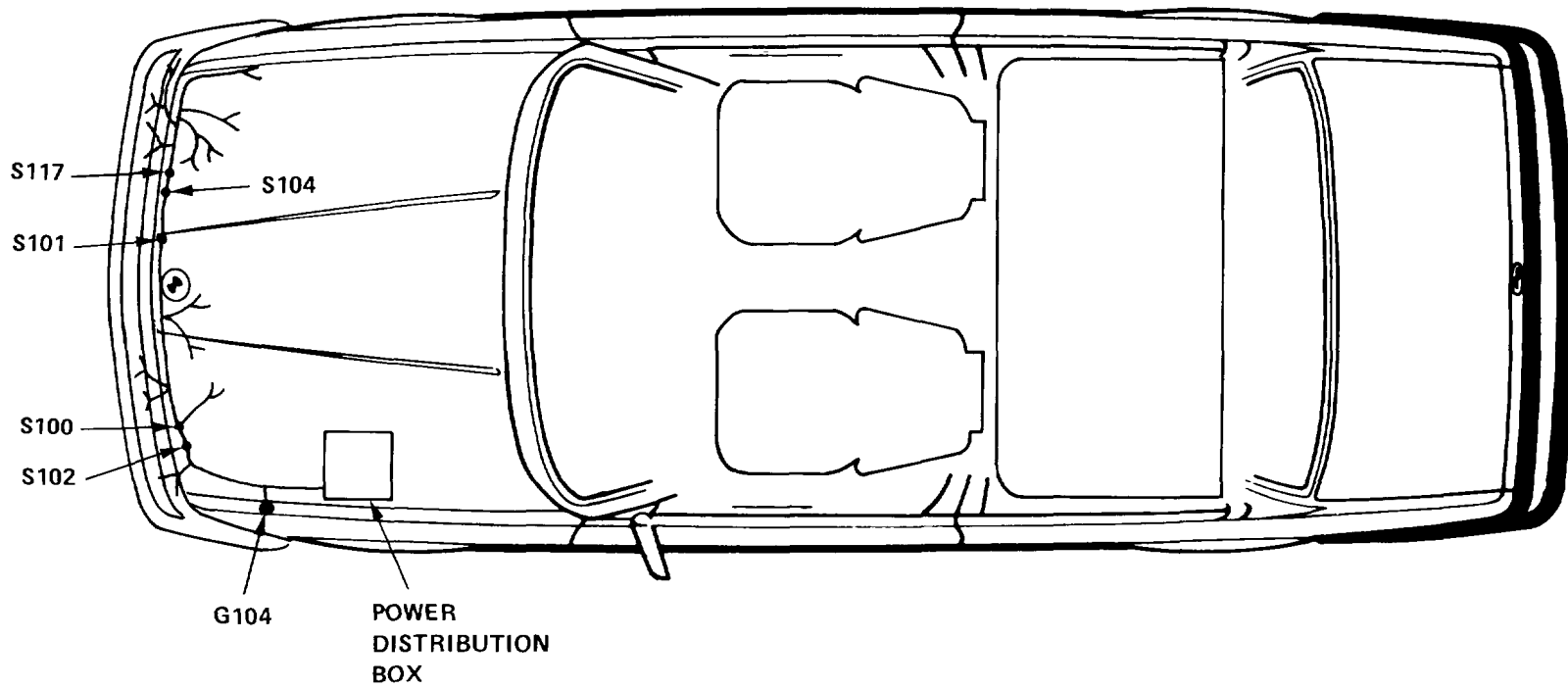

# 8000-4 SPLICE LOCATION VIEWS

## MIDDLE HARNESS

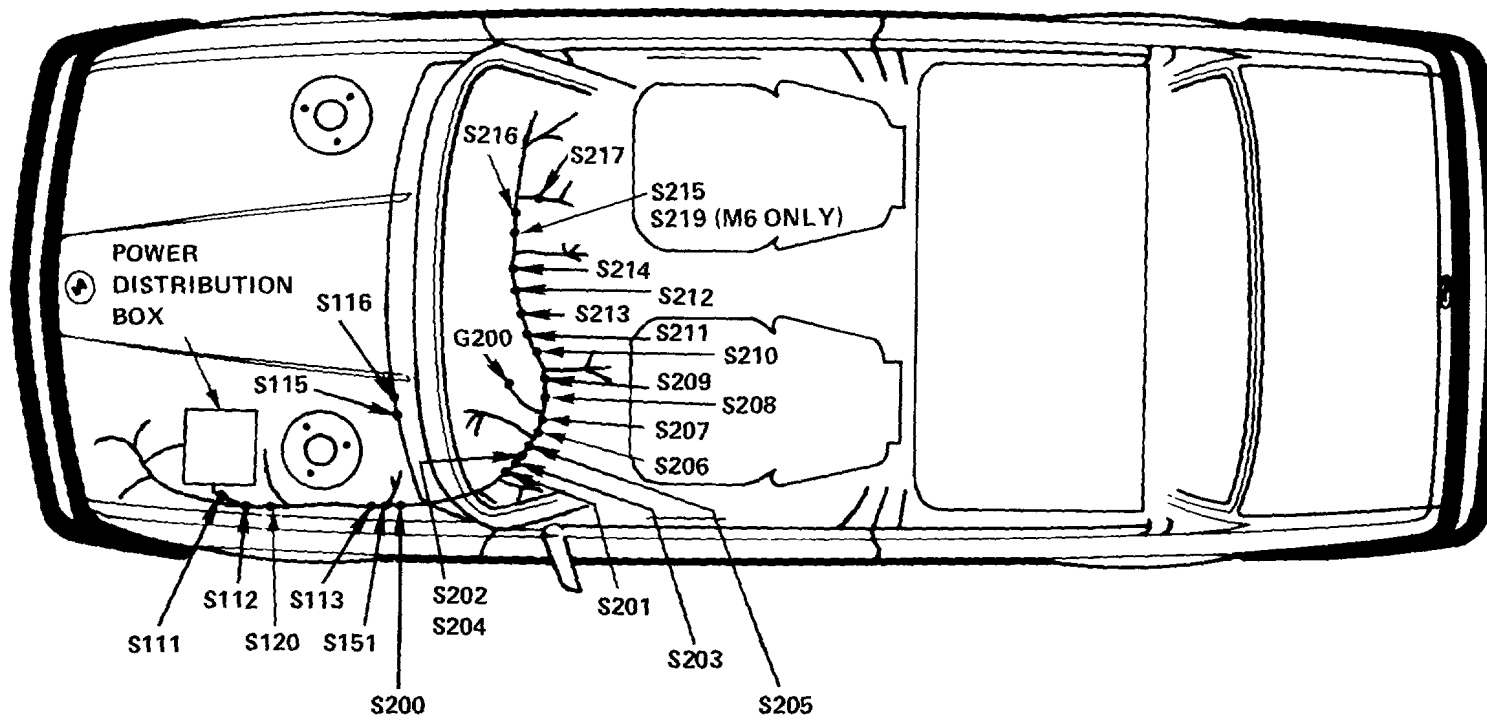



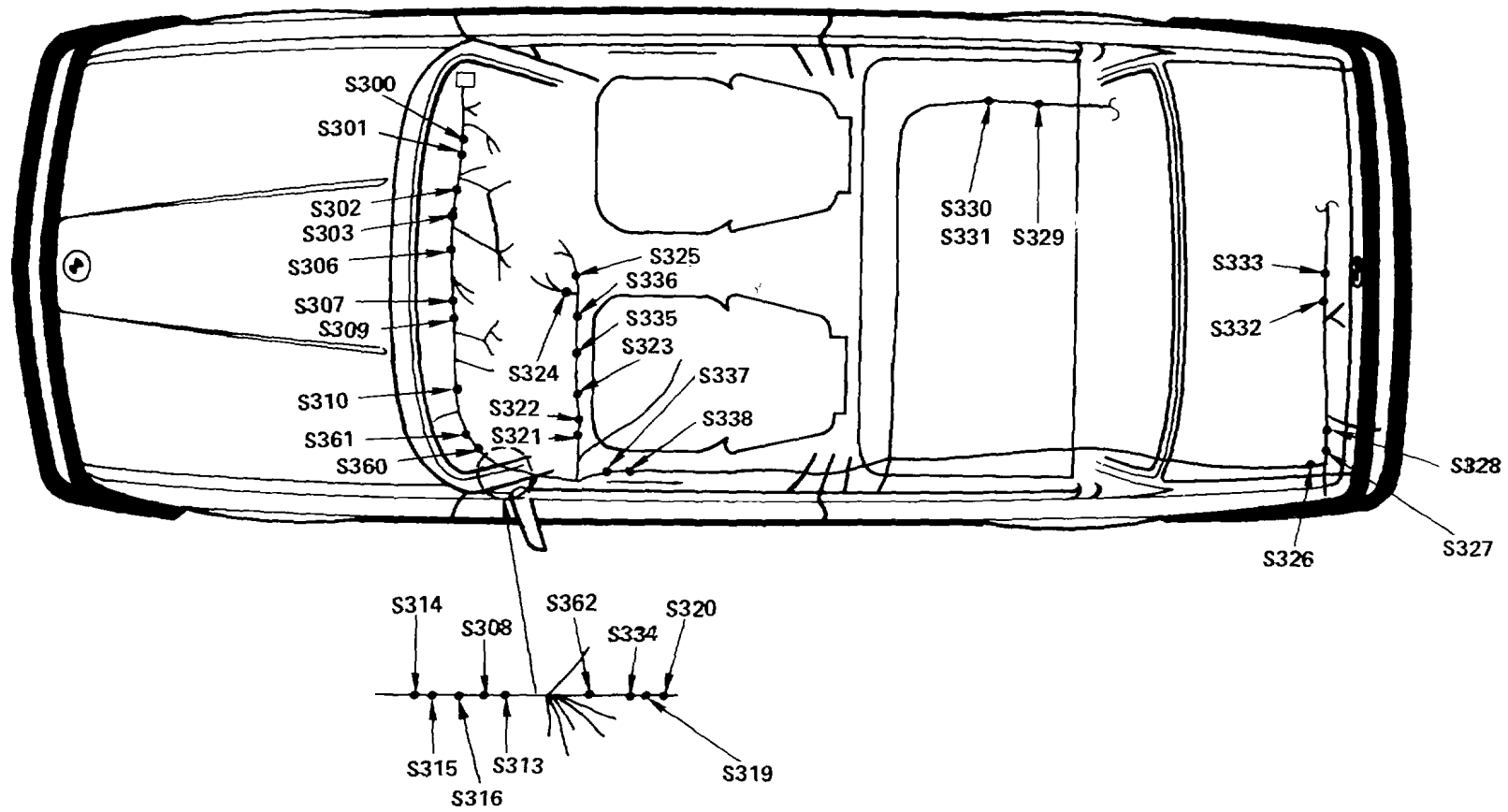

8000-6 SPLICE LOCATION VIEWS 3.5i ENGINE

ENGINE HARNESS

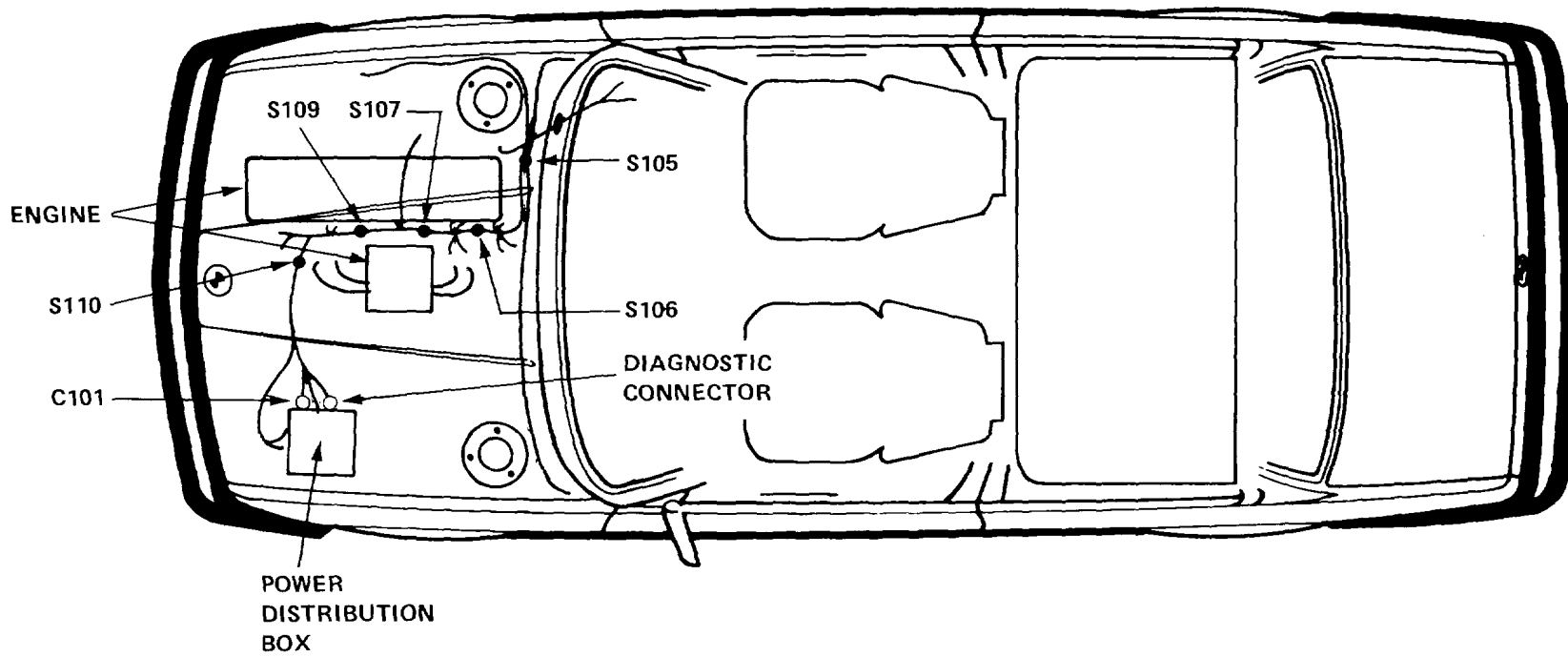

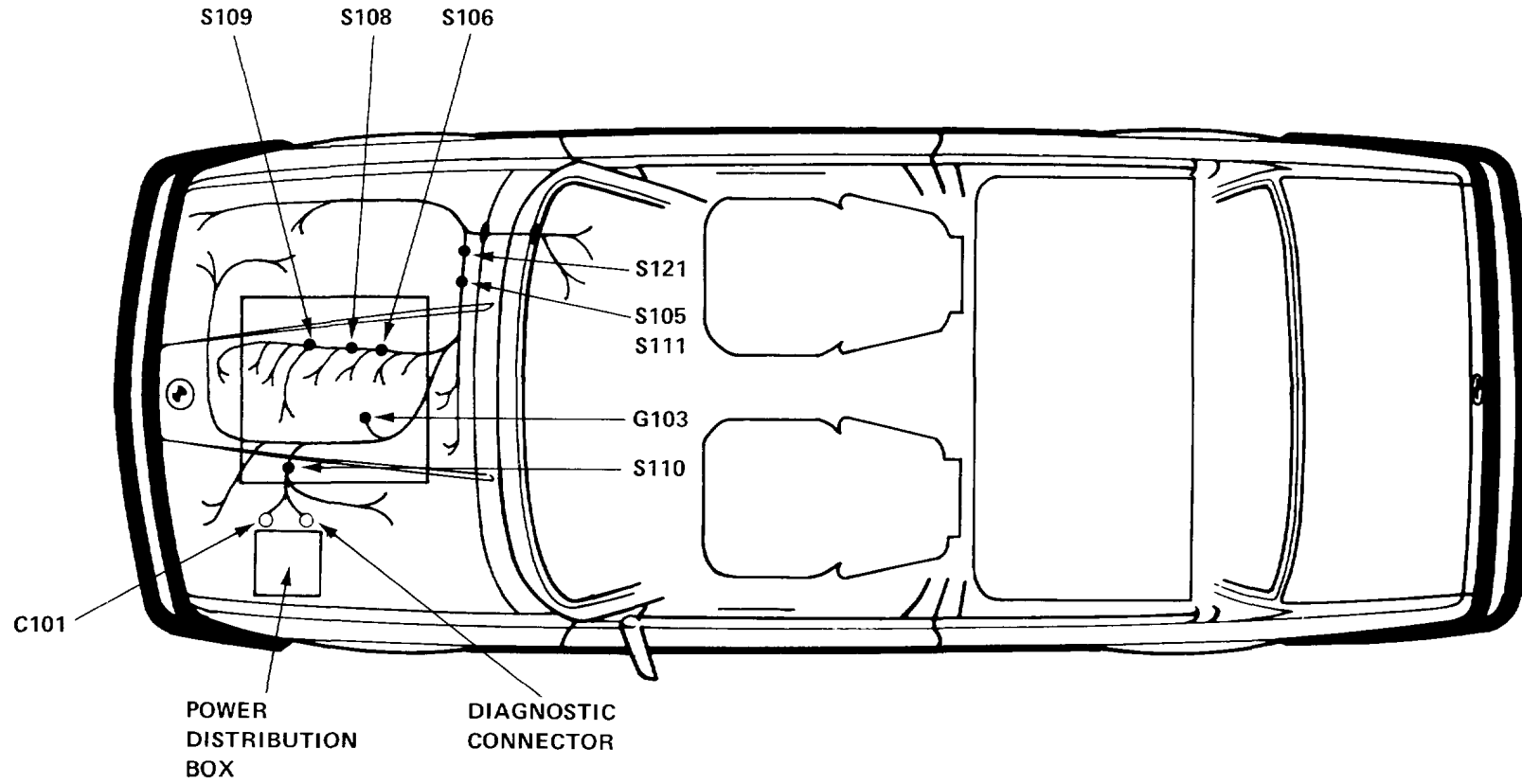

BATTERY POSITIVE HARNESS

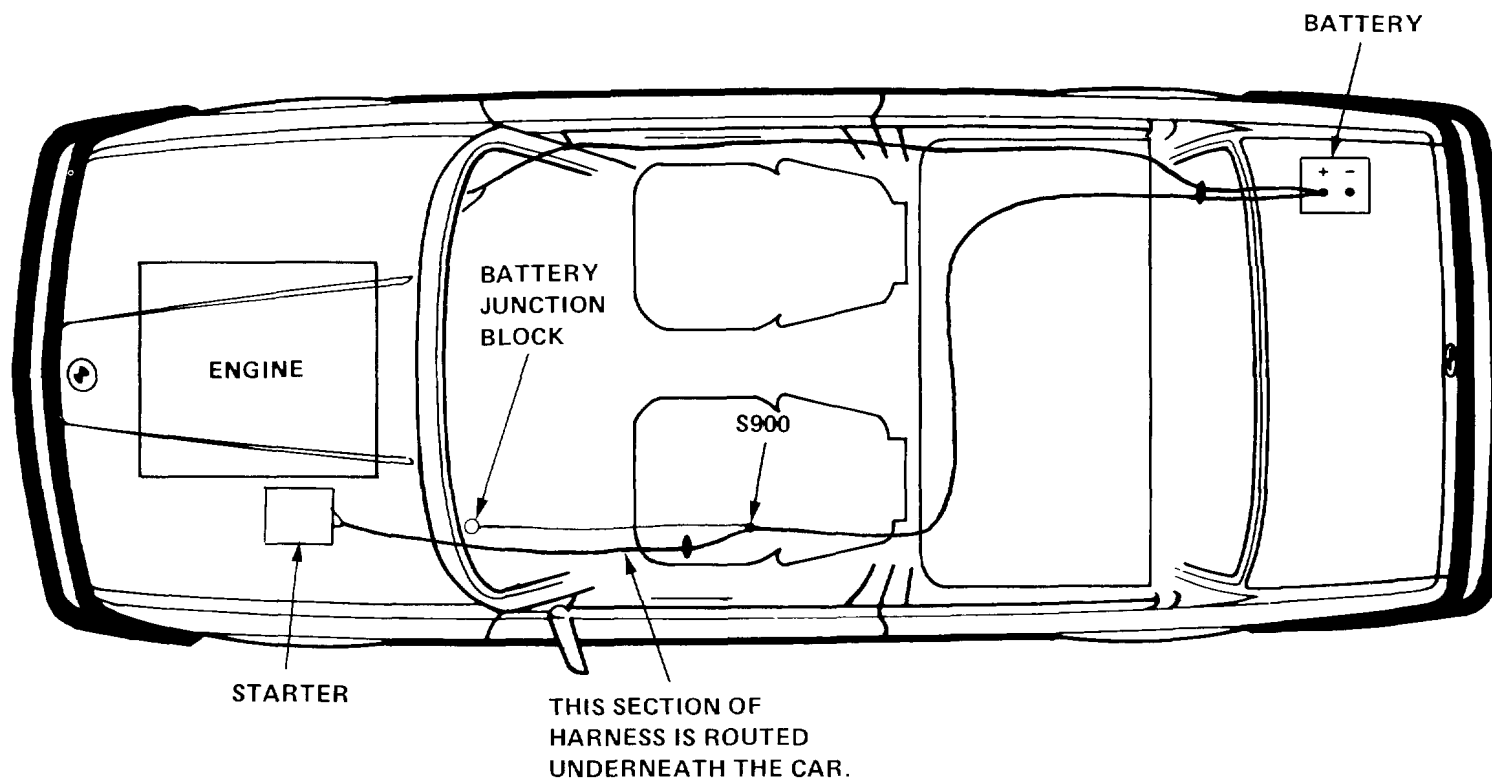

# 8500-0 CONNECTOR VIEWS

## ACCESSORY CONNECTOR (302)

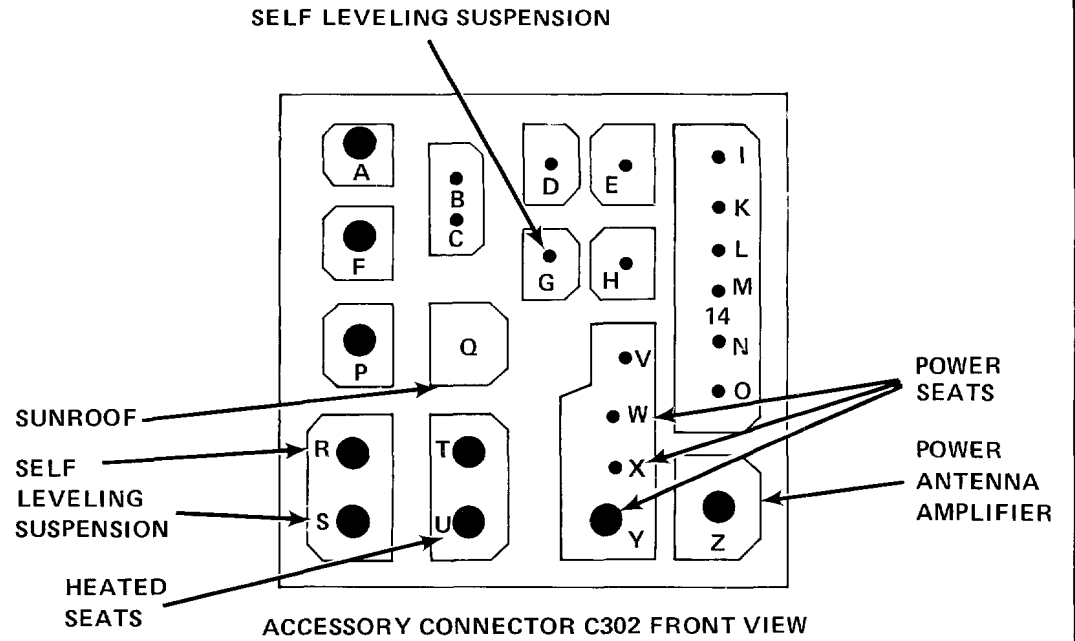
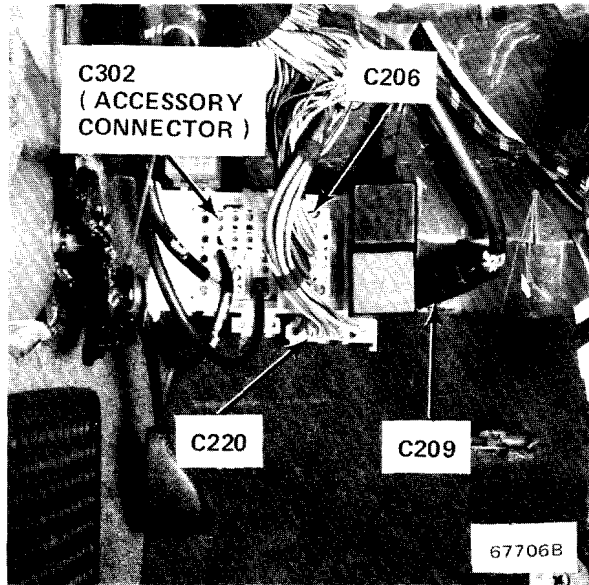
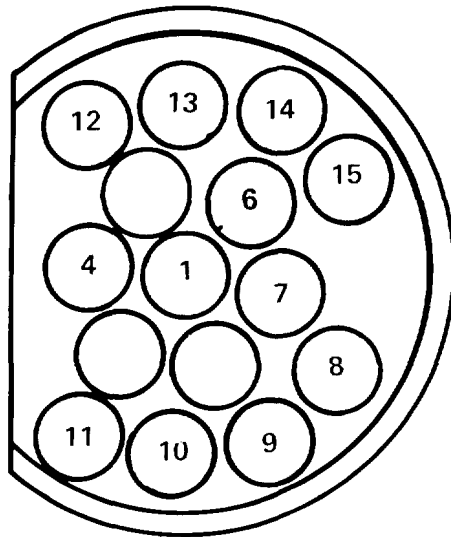

Figure 1 - Under Left Side Of Dash

DIAGNOSTIC CONNECTOR



DIAGNOSTIC CONNECTOR FACE

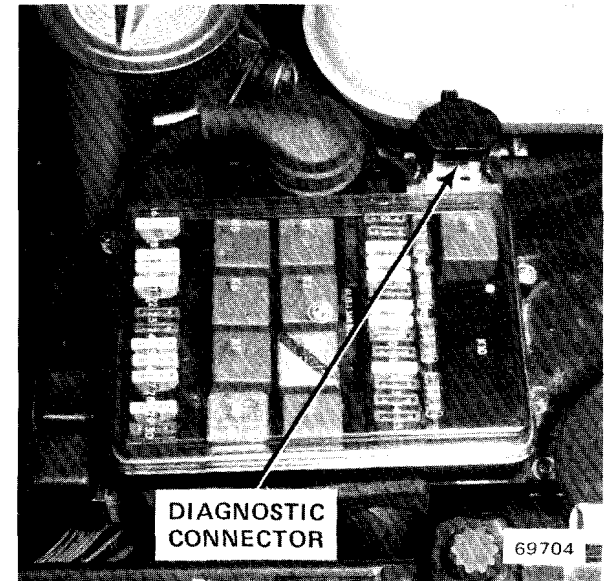
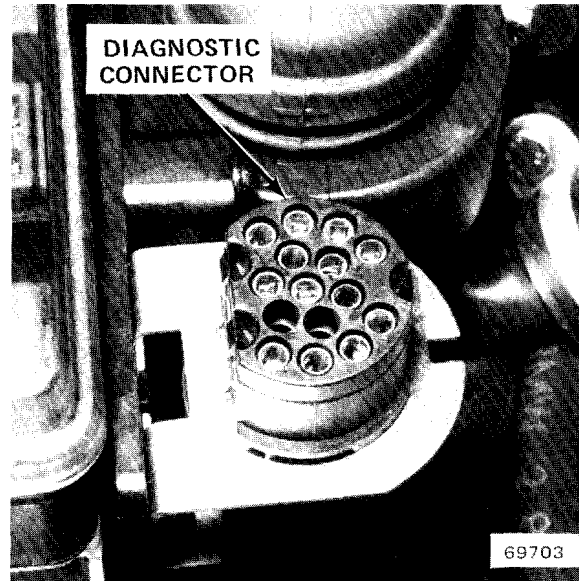

Figure 1 - On Power Distribution Box

Pin	Wire Size	Wire Color	Circuit and Component Connected
1	1.5	BR	Ground Distribution, G103
4	.75	BR/WT	Gauges/Warning Indicators, Coolant Temperature Sender
6	.75	WT/BK	SRS CONNECTOR (NOT USED)
7	.75	WT/BU	Service Interval Indicator, Service Interval Processor (Reset).
8	.5	YL	Ignition, TDC Sensor
9		SHIELD	Ignition, TDC Sensor
10	.5	BK	Ignition, TDC Sensor
11	2.5	BK/YL	Start, Start Signal
12	.75	BU	Charge System, Alternator
13	1	GN	Ignition, Ignition Coil
14	2.5	RD	Charge System, Alternator
15	1.5	GN/YL	Evaporative Purge Relay

## 8500-2 CONNECTOR VIEWS — S38 ENGINE

### DIAGNOSTIC CONNECTOR

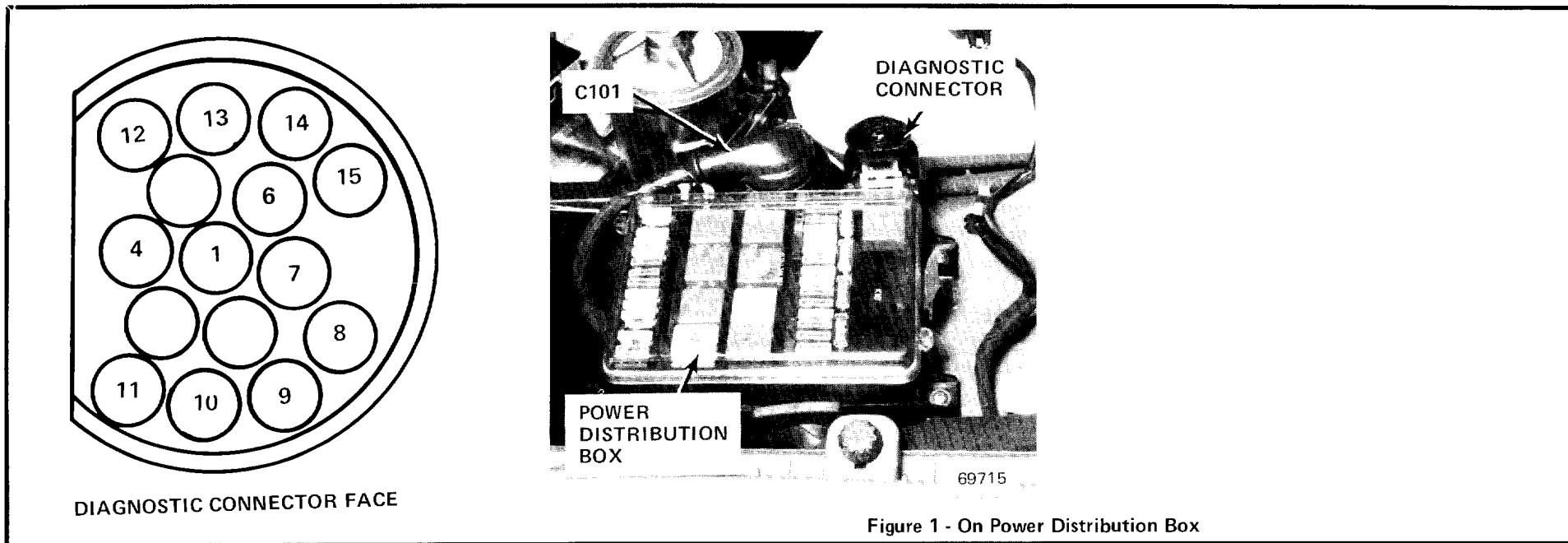
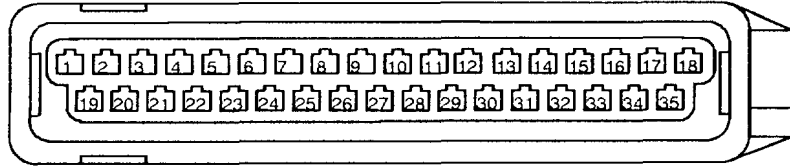

Figure 1 - On Power Distribution Box

Pin	Wire Size	Wire Color	Circuit and Component Connected
1	1.5	BR	Ground Distribution, G103
4	.75	BR/WT	Gauges/Warning Indicators, Coolant Temperature Sender
6	.75	WT/BK	SRS CONNECTOR (NOT USED)
7	.75	WT/BU	Service Interval Indicator, Service Interval Processor (Reset).
8	.5	YL	Ignition, TDC Sensor
9		SHIELD	Ignition, TDC Sensor
10	.5	BK	Ignition, TDC Sensor
11	2.5	BK/YL	Start, Start Signal
12	.75	BU	Charge System, Alternator
13	1	GN	Ignition, Ignition Coil
14	2.5	RD	Charge System, Alternator
15	1.5	GN/YL	Evaporative Purge Relay

B350002



Wiring Face

ABS ELECTRONIC CONTROL UNIT

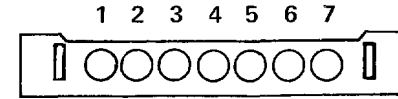

Wiring Face

AIR DOOR CONTROL

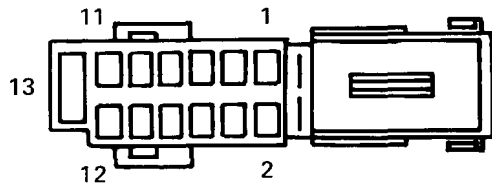

Mating Face

ABS HYDRAULIC UNIT

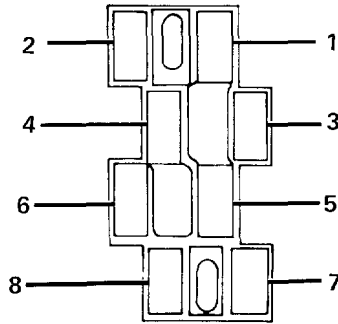

Wiring Face

A/C SELECTOR SWITCH

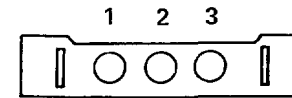

Wiring Face

AIR DOOR POTENTIOMETER

B260002.00

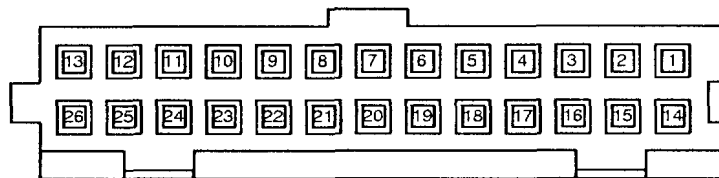

Wiring Face

ACTIVE CHECK CONTROL UNIT

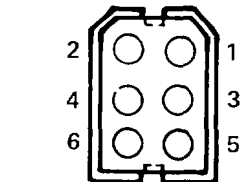

Wiring Face

A/C BLOWER HOUSING

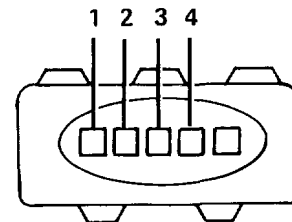

Wiring Face

AIR FLOW METER



# 8500-4 CONNECTOR VIEWS

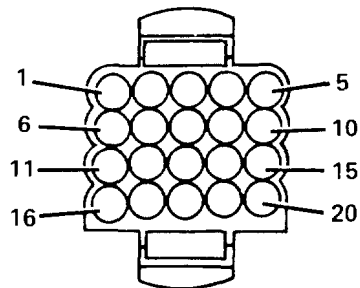

Wiring Face  
AMPLIFIER  
(SOUND SYSTEM)

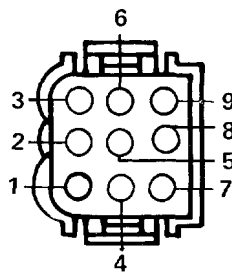

Wiring Face  
AUTOMATIC TRANSMISSION RANGE SWITCH

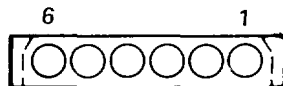

Wiring Face  
AUXILIARY EVAPORATOR

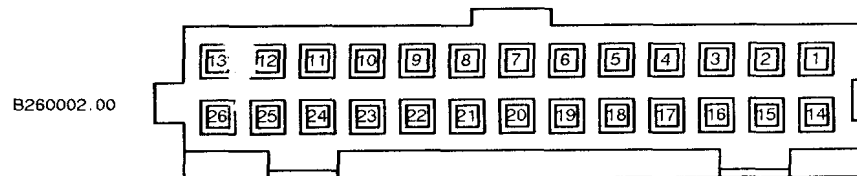

B260002.00

Wiring Face  
CRUISE CONTROL  
UNIT

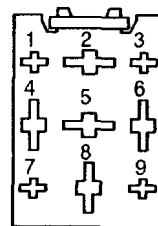

Wiring Face  
BLOWER SELECT RELAY

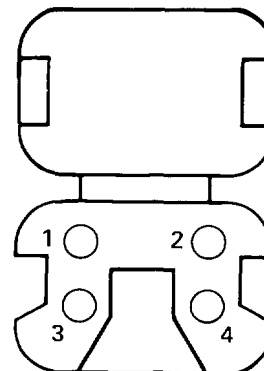

Wiring Face  
BLOWER SPEED  
CONTROL (C1)

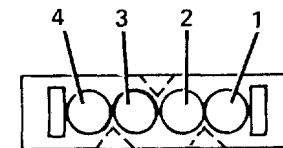

Wiring Face  
AUXILIARY HIGH LEVEL STOP LIGHT

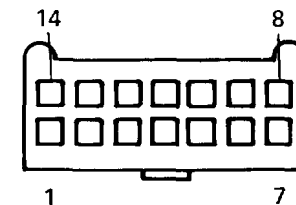

Wiring Face  
CENTRAL LOCKING CONTROL UNIT

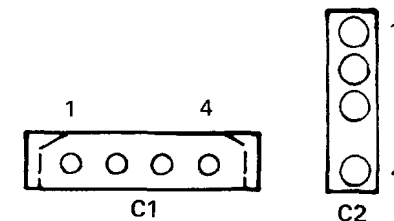

Wiring Face  
CHIME MODULE

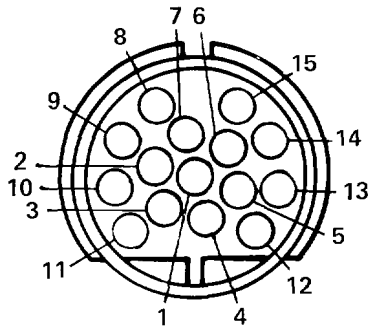

Mating Face  
DIAGNOSTIC CONNECTOR

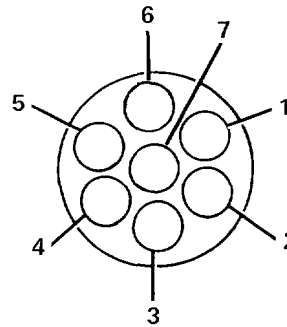

Wiring Face  
DRIVER'S SEAT (C8)

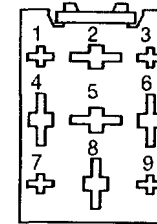

Wiring Face  
EVAPORATIVE PURGE RELAY

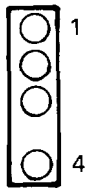

Wiring Face  
DIGITAL CLOCK

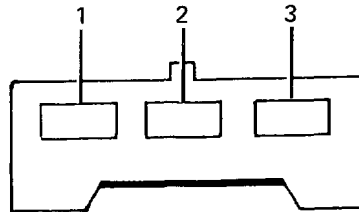

Wiring Face  
DRIVER'S SEAT (C9,C10,C11,C12)

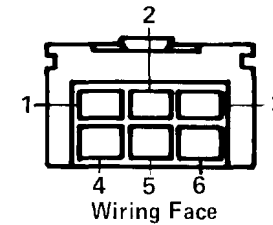

Wiring Face  
EVAPORATOR TEMPERATURE REGULATOR

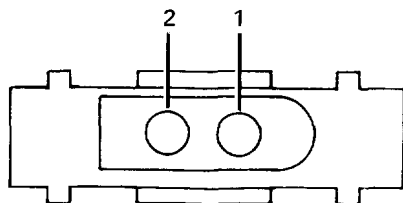

Wiring Face  
DRIVER'S SEAT (C6,C7,C13,C14)



Wiring Face  
DUAL COOLANT TEMPERATURE SWITCH

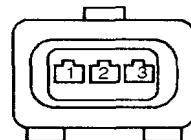

Engine Harness Wiring Face  
ENGINE SPEED SENSOR

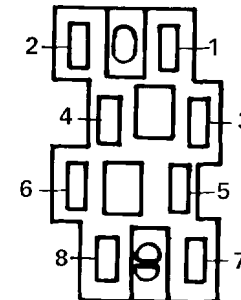

Mating Face  
FADER CONTROL

# 8500-6 CONNECTOR VIEWS

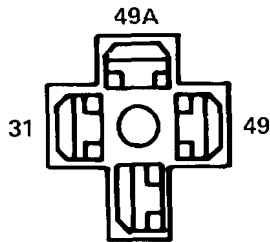

Wiring Face  
FLASHER

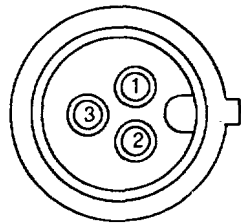

Wiring Face  
FRONT TURN PARK LIGHT

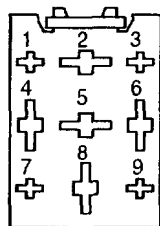

Wiring Face  
FUEL PUMP RELAY

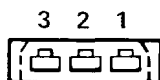

Wiring Face  
FUEL TANK SENDER

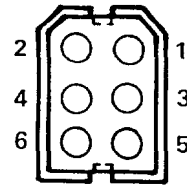

Wiring Face

## HEATER BLOWER HOUSING

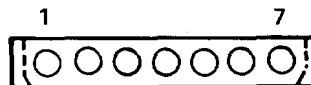

Wiring Face  
HEATER REGULATOR

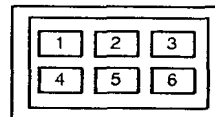

Wiring Face  
HYDRAULIC HEIGHT  
LEVEL CONTROL SYSTEM



Wiring Face  
IDLE SPEED ACTUATOR

B260002.00

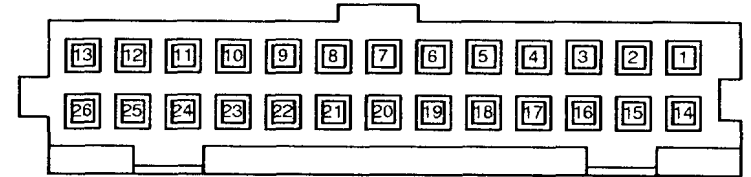

Mating Face  
INSTRUMENT CLUSTER

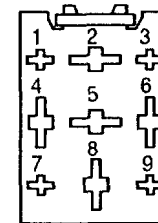

Wiring Face  
INTERIOR LIGHT  
TIMER CONTROL

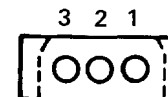

Wiring Face  
INTERIOR TEMPERATURE SENSOR

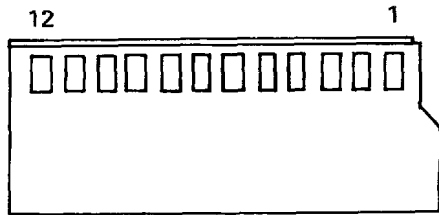

Mating Face  
LIGHT SWITCH

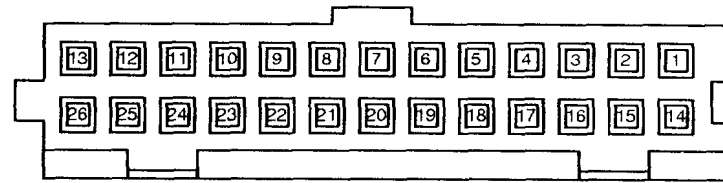

Wiring Face  
MEMORY SEAT  
CONTROL UNIT (C1)

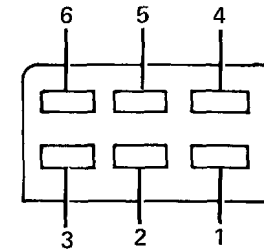

Wiring Face  
MEMORY SEAT CONTROL UNIT (C4)

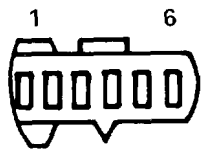

Wiring Face  
LOCK MOTOR (CENTRAL LOCKING)

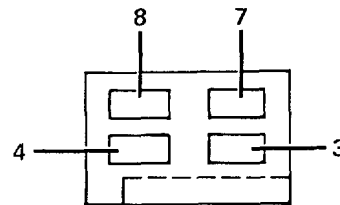

Wiring Face  
MEMORY SEAT CONTROL UNIT (C2)

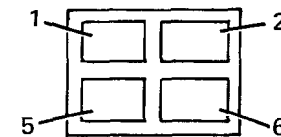

Wiring Face  
MEMORY SEAT CONTROL UNIT (C5)

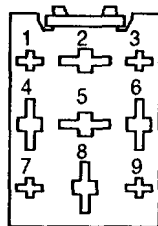

Wiring Face  
MAIN RELAY

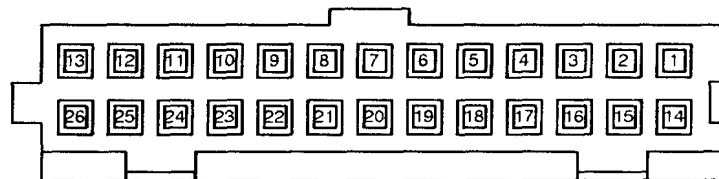

Wiring Face  
MEMORY SEAT  
CONTROL UNIT (C3)

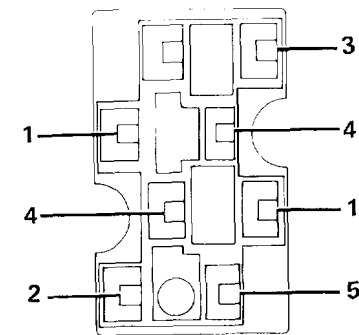

Wiring Face  
MEMORY SWITCH

# 8500-8 CONNECTOR VIEWS

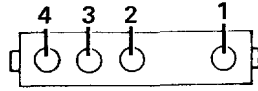

Wiring Face  
MIRROR

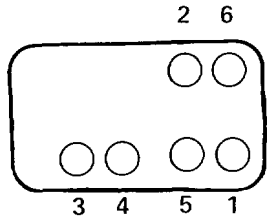

Mating Face  
MIRROR CONTROL SWITCH

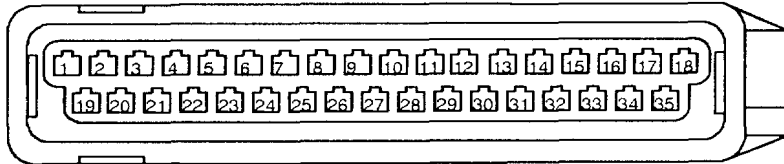

Mating Face  
MOTRONIC CONTROL UNIT

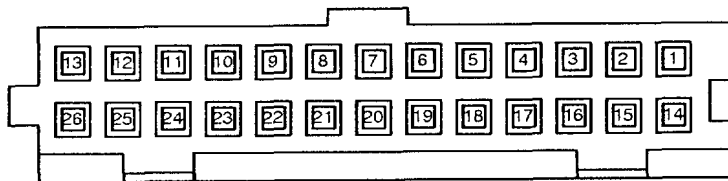

Wiring Face  
ON BOARD COMPUTER MODULE

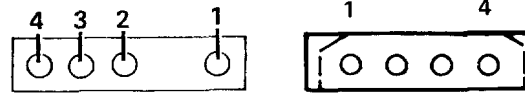

Wiring Face C1      Wiring Face C2  
ON-BOARD COMPUTER RELAY BOX

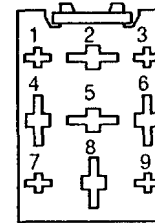

Wiring Face  
OXYGEN SENSOR/  
FUEL PUMP RELAY

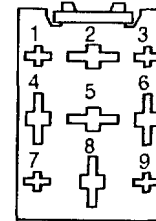

Wiring Face  
OXYGEN SENSOR RELAY

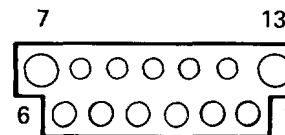

Wiring Face  
PASSENGER SEAT CONTROLLER (C1)



Wiring Face  
PROGRAM SWITCH (C1)  
(ELECTRONIC TRANSMISSION)

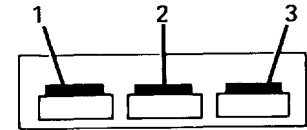

Wiring Face  
PROGRAM SWITCH (C2)  
(ELECTRONIC TRANSMISSION)

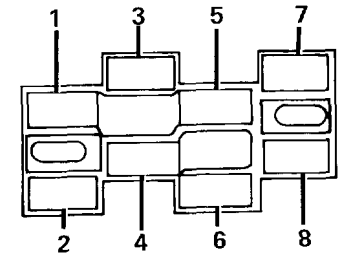

Wiring Face  
REAR DEFOGGER SWITCH

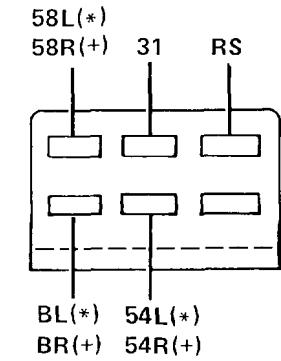

REAR LIGHT ASSEMBLY (\*)=LEFT SIDE (+)=RIGHT SIDE

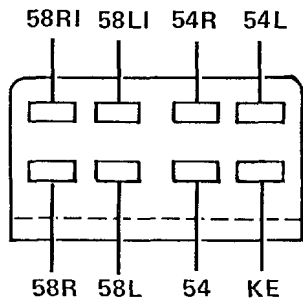

Wiring Face  
REAR LIGHTS CHECK RELAY (C1)

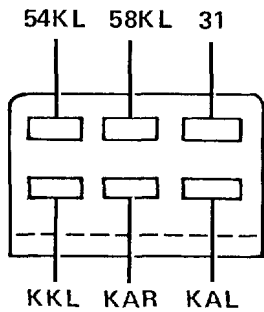

Wiring Face  
REAR LIGHTS CHECK RELAY (C2)

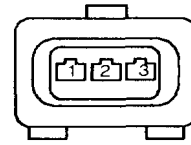

Wiring Face  
REFERENCE POINT SENSOR

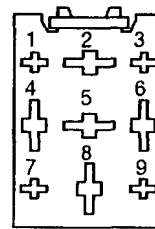

Wiring Face  
SEATBELT WARNING TIMER

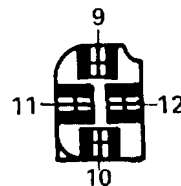

Wiring Face  
SEAT SWITCH (C1)  
(HEADREST)

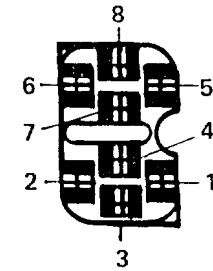

Wiring Face  
SEAT SWITCH (C2)  
(FRONT/REAR)

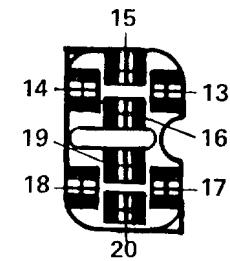

Wiring Face  
SEAT SWITCH (C3)  
(ENTIRE SEAT/SEAT BACK RECLINER)

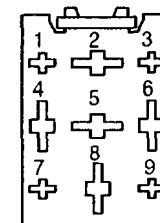

Wiring Face  
START RELAY

# 8500-10 CONNECTOR VIEWS

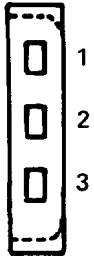

Wiring Face  
SUNROOF MOTOR (CI)

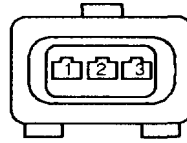

Wiring Face  
THROTTLE SWITCH  
(MANUAL TRANSMISSION)

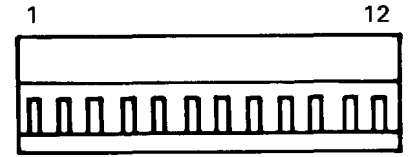

Wiring Face  
TRANSMISSION RANGE DISPLAY

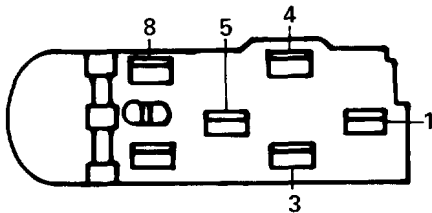

Wiring Face  
SUNROOF SWITCH

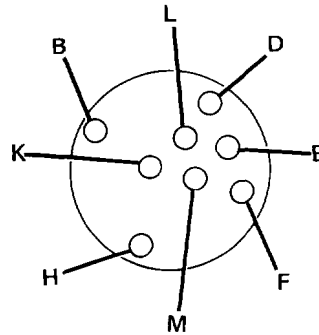

Wiring Face  
TRANSMISSION

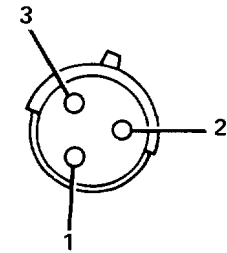

Mating Face  
UNLOCK INHIBIT SWITCH

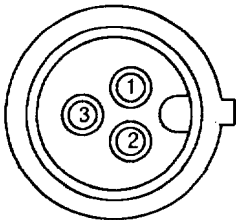

Wiring Face  
THROTTLE POSITION SENSOR  
(ELECTRONIC TRANSMISSION)

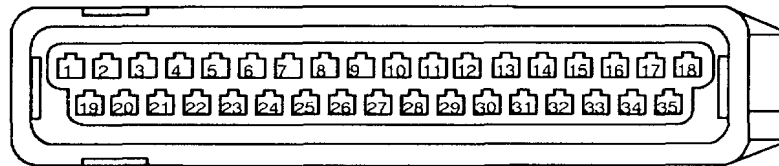

Mating Face  
TRANSMISSION CONTROL UNIT

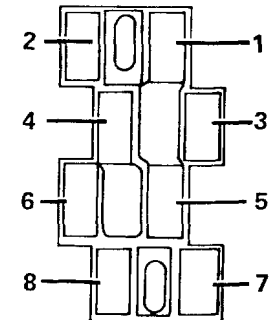

Wiring Face  
WINDOW SWITCHES

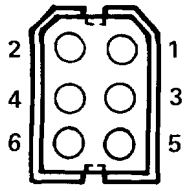

Wiring Face  
WIPER MOTOR

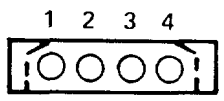

Wiring Face  
C103

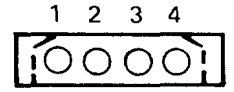

Wiring Face  
C132

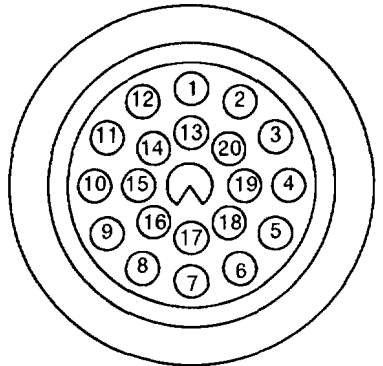

Wiring Face  
C101

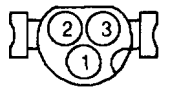

Wiring Face  
C113

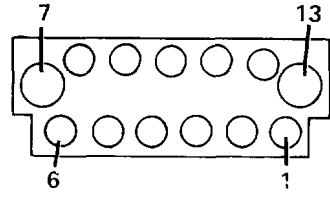

Wiring Face  
C133



Wiring Face  
C114

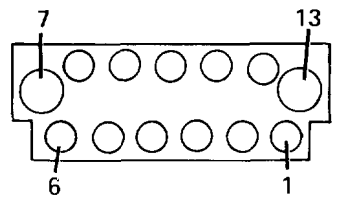

Wiring Face  
C102

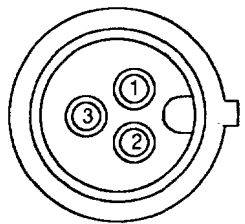

Wiring Face  
C141



# 8500-12 CONNECTOR VIEWS

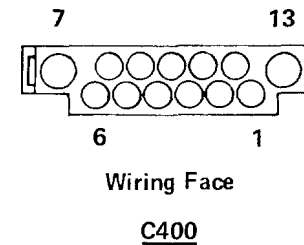
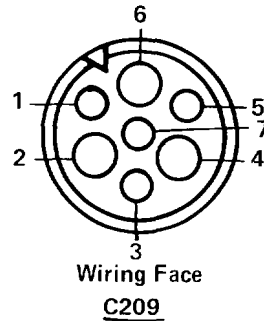
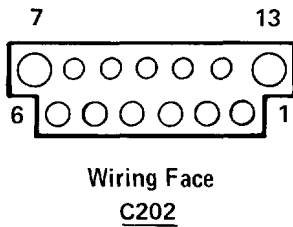
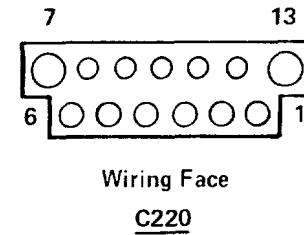
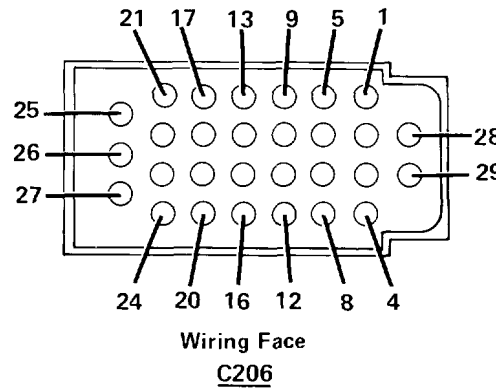
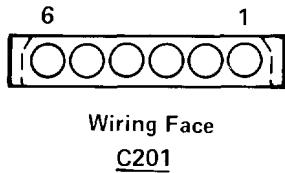
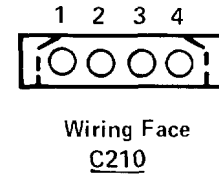
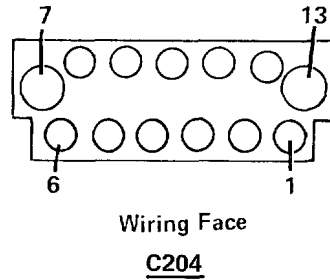
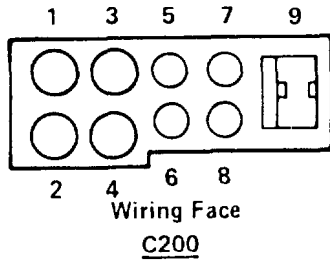

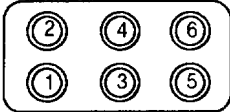

Wiring Face

C353

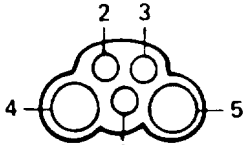

Wiring Face

C551

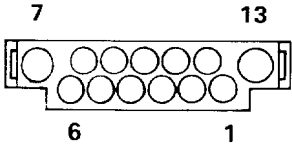

Wiring Face

C401

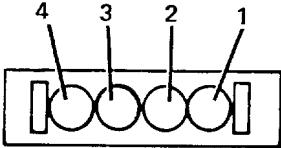

Wiring Face

C402

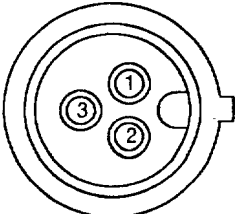

Wiring Face

C503

## 9000-0 COMPONENT LOCATION CHART

COMPONENTS		Page-Figure
A/C Blower Housing . . . . .	Behind center console	
A/C In-Line Diode . . . . .	On RH side of A/C compressor . . . . .	7000- 2-5
A/C Temperature Switch . . . . .	Top LH side of radiator . . . . .	7000- 8-2
ABS Electronic Control Unit . . . . .	Below RH side of windshield, behind shock tower . . . . .	7000- 0-3
ABS Hydraulic Unit . . . . .	Right of LH front wheel well . . . . .	7000- 0-1
Active Check Control Module . . . . .	In dash, left of steering column	
Air Flow Meter . . . . .	Top RH side of engine . . . . .	7000- 1-6
Air Flow Meter (M6) . . . . .	Front LH side of engine compartment . . . . .	7000- 8-2
Amplifier . . . . .	RH side of trunk . . . . .	7000- 6-5
Auto-Charging Flashlight . . . . .	In glove box	
Automatic Transmission Range Switch . . . . .	On LH side of shift lever	
Auxiliary Fan . . . . .	Ahead of radiator . . . . .	7000- 3-1
Auxiliary Fan Blocking Diode . . . . .	Inside power distribution box . . . . .	7000- 2-6
Auxiliary Fuel Pump . . . . .	RH side of trunk floor, below access panel . . . . .	7000- 6-2
Auxiliary Fuse (M6) . . . . .	LH side of engine compartment, near coolant reservoir . . . . .	7000- 2-6
B/C Horn Diode . . . . .	Near alarm horn	
Back Up Light Switch . . . . .	On LH side of manual transmission	
Barometric Pressure Sensor . . . . .	RH front of engine compartment . . . . .	7000- 8-5
Battery . . . . .	RH rear of trunk . . . . .	7000- 9-4
Blower Select Relay . . . . .	Under dash, left of glove box . . . . .	7000- 4-6
Board Computer Horn . . . . .	Under LH side of fresh air intake cowl . . . . .	7000- 0-6
Brake Accumulative Pressure Switch . . . . .	Right of LH front shock tower . . . . .	7000- 1-4
Brake Fluid Level Switch . . . . .	To left of engine, on brake fluid reservoir . . . . .	7000- 1-4
Brake Switch . . . . .	Above brake pedal . . . . .	7000- 3-4
Central Locking Control Unit . . . . .	Under dash, left of glove box . . . . .	7000- 4-6
Chime Module . . . . .	Under LH side of dash, on hush panel . . . . .	7000- 3-5
Clutch Switch . . . . .	Above clutch pedal . . . . .	7000- 3-4
Cold Start Valve . . . . .	Between intake ports 3 and 4	
Combination Switch . . . . .	On LH side of steering column . . . . .	7000- 4-4
Compressor Clutch . . . . .	On front of A/C compressor	
Coolant Level Switch . . . . .	Top of coolant reservoir . . . . .	7000- 1-3
Coolant Temperature Sender/ Switch . . . . .	Front of engine, on thermostat housing . . . . .	7000- 0-4
Coolant Temperature Sensor . . . . .	Front of engine, top of thermostat housing . . . . .	7000- 0-4
Coolant Temperature Sensor (M6) . . . . .	RH side of engine, on coolant manifold . . . . .	7000- 8-6
Coolant Temperature Switch . . . . .	RH side of engine, on coolant manifold . . . . .	7000- 8-6
Cruise Control Actuator . . . . .	RH side of LH front wheel well . . . . .	7000- 0-1
Cruise Control Control Unit . . . . .	Under LH side of dash, above speaker . . . . .	7000- 4-3
Diagnostic Connector . . . . .	On LH front wheel well, near power distribution box	7000- 0-1

Diagnostic Connector (M6) . . . . .	LH side of engine compartment . . . . .	7000- 7-6
Door Lock Motors . . . . .	In each door, behind panel . . . . .	7000- 5-6
Driver's Seat Controller . . . . .	Under driver's seat, on frame	
Driver's Seat Switches . . . . .	On center console, left of shift lever . . . . .	7000- 5-5
Dual Coolant Temperature Switch . . . . .	Upper RH side of radiator . . . . .	7000- 2-1
Dual Coolant Temperature Switch (M6) . . . . .	Top LH side of radiator . . . . .	7000- 8-2
Engine Speed Sensor . . . . .	On LH side of transmission bell housing . . . . .	7000- 1-6
Engine Speed Sensor (M6) . . . . .	Lower LH rear of engine . . . . .	7000- 9-1
Evaporative Purge Relay . . . . .	RH front of engine compartment . . . . .	7000- 8-5
Evaporative Purge Valve . . . . .	RH front of engine compartment . . . . .	7000- 8-5
Evaporator Temperature Regulator . . . . .	On LH side of heater-A/C unit . . . . .	7000- 3-3
Evaporator Temperature Sensor . . . . .	In center console, below back of radio	
Fader Control . . . . .	In center console, below radio face . . . . .	7000- 5-3
Filter Capacitor . . . . .	On back of alternator	
Flasher . . . . .	Upper LH side of steering column . . . . .	7000- 4-4
Fresh Air Door Control Unit . . . . .	Under dash, left of glove box	
Front Speed Detectors . . . . .	Back of front wheels, on dust shields . . . . .	7000- 7-4
Fuel Injectors . . . . .	Top of engine, near each cylinder	
Fuel Pump Relay . . . . .	On power distribution box . . . . .	7000- 1-1
Fuel Tank Sender Switch . . . . .	RH side of trunk floor, below access panel . . . . .	7000- 6-2
Gas Filler Lock Motor . . . . .	In trunk, behind RH rear wheel well . . . . .	7000- 6-5
Heater Blower Housing . . . . .	Behind center console	
Heater Regulator . . . . .	Behind temperature select control	
Heater Temperature Sensor . . . . .	On LH side of heater-A/C unit . . . . .	7000- 3-3
High Pressure Cut-Out Switch . . . . .	On receiver-drier . . . . .	7000- 0-2
Horn Brush/Slip Ring . . . . .	Under hub of steering wheel	
Horn Switches . . . . .	On steering wheel	
Hydraulic Height Level Control System . . . . .	In trunk, under spare tire . . . . .	7000- 9-3
Hydraulic Low Pressure Switch . . . . .	Under LH side of car, front of rear axle . . . . .	7000- 9-2
Hydraulic Pressure Switch . . . . .	Right of LH front shock tower . . . . .	7000- 1-5
Idle Speed Actuator . . . . .	Top RH side of engine . . . . .	7000- 0-5
Idle Speed Actuator (M6) . . . . .	Top center of engine . . . . .	7000- 8-3
Ignition Coil . . . . .	On RH wheel well, behind headlights . . . . .	7000- 0-2
Ignition Key Switch . . . . .	In upper part of steering column . . . . .	7000- 4-4
Ignition Switch . . . . .	In upper part of steering column . . . . .	7000- 4-4
Intensive Washer Pump . . . . .	Behind RH front shock tower, in reservoir . . . . .	7000- 0-3
Interior Light Timer Control . . . . .	Under LH side of dash, on body electrical bracket . . . . .	7000- 4-1
Interior Temperature Sensor . . . . .	Under LH side of dash . . . . .	7000- 3-5
Jet Heaters . . . . .	On washer jet nozzles	
Level Control Unit . . . . .	Under LH side of car, front of rear axle . . . . .	7000- 9-2

## 9000-2 COMPONENT LOCATION CHART

LH Front Brake Wear Sensor . . .	Near caliper, connected to brake pad . . . . .	7000- 7-1
Lock Heater . . . . .	In LH front door, on door lock	
Lock Heater Control Unit . . . . .	In left front door, near door lock	
Lock Inhibit Switch . . . . .	In passenger's door, at lock cylinder	
Main Fuel Pump . . . . .	Under car, above right rear axle	
Main Relay . . . . .	On power distribution box . . . . .	7000- 0-1
Main Relay (M6) . . . . .	Under RH side of dash, above glove box . . . . .	7000-10-1
Memory Seat Control Module . .	Under front of driver's seat	
Memory Switches . . . . .	On center console, left of shift lever . . . . .	7000- 5-5
Motronic Control Unit . . . . .	Under RH side of dash, above glove box . . . . .	7000- 4-5
Normal Speed Blower Resistor . .	Ahead of radiator, on auxiliary fan shield . . . . .	7000- 3-1
Normal Washer Pump . . . . .	Ahead of RH front wheel well, in reservoir . . . . .	7000- 2-2
Oil Level Sensor . . . . .	Bottom of engine oil pan . . . . .	7000- 7-2
Oil Pressure Switch . . . . .	Left rear end of cylinder head . . . . .	7000- 2-4
On-Board Computer Module . . .	In center console, right of radio face . . . . .	7000- 5-3
On-Board Computer Relay Box . .	Under LH side of dash, above speaker . . . . .	7000- 4-3
Outside Temperature Sensor . . .	Under LH front side of bumper	
Oxygen Sensor . . . . .	Underneath car, on catalytic converter	
Oxygen Sensor Heater Relay . . .	On power distribution box . . . . .	7000- 1-1
Oxygen Sensor/Fuel Pump Relay	Behind RH side of dash, above glove box . . . . .	7000-10-1
Park Brake Switch . . . . .	In shift console, at base of parking brake	
Passenger's Seat Controller . . .	Under passenger's seat, on frame	
Passenger's Seat Switches . . . .	On center console, right of shift lever . . . . .	7000- 5-5
Potentiometer . . . . .	Under dash, left of glove box	
Power Antenna . . . . .	RH side of trunk, near hinge . . . . .	7000- 6-1
Power Distribution Box . . . . .	Top front of left front wheel well . . . . .	7000- 1-1
Power Distribution Box (M6) . . .	LH side of engine compartment . . . . .	7000- 7-6
Power Window Circuit Breaker . .	In center console, below radio face . . . . .	7000- 5-3
Program Selector Switch . . . . .	On center console, to right of shift lever . . . . .	7000- 5-4
Pulse Wheels . . . . .	Inner sides of rotors . . . . .	7000- 7-3
Rear Blower Driver . . . . .	Under rear console, top front of rear evaporator . . . .	7000-10-3
Rear Blower Motor . . . . .	Under rear console, front of rear evaporator . . . . .	7000-10-3
Rear Evaporator Temperature Sensor . . . . .	Under rear console, in rear evaporator . . . . .	7000-10-3
Rear Lights Check Relay . . . . .	In trunk, left of rear panel center support . . . . .	7000- 6-3
Rear Speed Detectors . . . . .	Back of rear wheels, near brake assembly . . . . .	7000- 7-3
Reference Point Sensor . . . . .	On LH side of transmission bell housing . . . . .	7000- 1-6
Reference Point Sensor (M6) . . .	Lower LH rear of engine . . . . .	7000- 9-1
RH Rear Brake Wear Sensor . . . .	Near caliper, connected to brake pad . . . . .	7000- 7-1
Safety Switch . . . . .	In center console, to left of shift lever . . . . .	7000- 5-4
Seatbelt Switch . . . . .	In driver's seatbelt buckle	
Seatbelt Warning Timer . . . . .	Under LH side of dash, on body electrical bracket . .	7000- 4-1
Speedometer Sender . . . . .	In rear of differential	
Start Relay . . . . .	Under LH side of dash, on body electrical bracket . .	7000- 4-1

Starter . . . . .	Lower LH rear of engine	
Stepping Motor . . . . .	Under dash, left of glove box	
Sunroof Motor . . . . .	Above headliner, above rear view mirror	
Sunroof Motor Relay . . . . .	Above headliner, above rear view mirror	
TDC Sensor . . . . .	Above crankshaft vibration damper . . . . .	7000- 2-5
TDC Sensor (M6) . . . . .	RH front of engine, above A/C compressor . . . . .	7000- 8-4
Thermo-Time Switch . . . . .	Front of engine, top of thermostat housing . . . . .	7000- 0-4
Throttle Position Sensor . . . . .	Top center of engine, behind rubber boot . . . . .	7000- 2-3
Throttle Switch . . . . .	Top LH side of engine, below throttle body . . . . .	7000- 2-3
Throttle Switch (M6) . . . . .	Top front center of engine compartment . . . . .	7000- 8-3
Transmission Control Unit . . . . .	Under LH side of dash, above speaker . . . . .	7000- 4-3
Transmission Kickdown Switch . . . . .	Passenger compartment, under accelerator pedal	
Trunk Light Switch . . . . .	In trunk lid, near trunk lock	
Trunk Lock Motor . . . . .	In trunk, in trunk lock support. . . . .	7000- 6-3
Underhood Light Switch . . . . .	Left of RH hood hinge	
Unlock Inhibit Switch . . . . .	In driver's door, at lock cylinder	
Washer Fluid Level Switch . . . . .	Ahead of RH front wheel well, in reservoir . . . . .	7000- 0-2
Water Shut-Off Valve . . . . .	Center rear of engine compartment . . . . .	7000- 1-5
Window Motors . . . . .	In each door, behind panel	
Wiper Motor . . . . .	Under LH side of fresh air intake cowl . . . . .	7000- 0-6

**CONNECTORS**

C101 (17 pins) . . . . .	On RH side of power distribution box. . . . .	7000- 0-1
C101 (17 pins) (M6) . . . . .	LH side of engine compartment . . . . .	7000- 7-6
C102 (6 pins) (M6) . . . . .	Inside power distribution box . . . . .	7000- 2-6
C102 (13 pins) . . . . .	Inside power distribution box . . . . .	7000- 2-6
C103 (4 pins) . . . . .	Under RH side of dash, above glove box . . . . .	7000- 4-5
C106 (1 pin) . . . . .	Behind right headlights . . . . .	7000- 2-2
C110 (2 pins) . . . . .	Ahead of right headlights' access panel	
C111 (2 pins) . . . . .	Underside of hood, near LH washer jet nozzle	
C112 (2 pins) . . . . .	Underside of hood, near RH washer jet nozzle	
C113 (3 pins) . . . . .	LH side of auxiliary fan shield . . . . .	7000- 3-1
C114 (8 pins) . . . . .	In power distribution box, on underside of printed circuit board	
C115 (2 pins) . . . . .	In power distribution box, on underside of printed circuit board	
C126 (2 pins) . . . . .	Behind LH side of front spoiler	
C127 (2 pins) . . . . .	Behind RH side of front spoiler	
C132 (4 pins) . . . . .	Under RH side of dash, above glove box . . . . .	7000- 4-5
C133 (13 pins) . . . . .	Under RH side of dash, above glove box	
C141 (3 pins) . . . . .	Mounted underneath car, left front of transmission	
C150 (2 pins) . . . . .	Behind LH front shock tower . . . . .	7000- 0-6
C151 (2 pins) . . . . .	Behind RH front shock tower . . . . .	7000- 0-3
C152 (8 pins) . . . . .	Under center of car, near transmission	

## 9000-4 COMPONENT LOCATION CHART

---

C153 (3 pins)	Center rear of engine compartment, on bulkhead . . .	7000- 7-5
C154 (3 pins)	Center rear of engine compartment, on bulkhead . . .	7000- 7-5
C200 (10 pins)	Under LH side of dash, on LH side of steering column . . . . .	7000- 3-2
C201 (6 pins)	Under LH side of dash, on LH side of steering column . . . . .	7000- 3-2
C202 (13 pins)	Under LH side of dash, on LH side of steering column . . . . .	7000- 3-2
C204 (13 pins)	Behind center console, above radio	
C205 (1 pin)	Under LH side of dash	
C206 (29 pins)	Under LH side of dash, on body electrical bracket . .	7000- 4-2
C208 (2 pins)	Above clutch pedal . . . . .	7000- 3-4
C209 (7 pins)	Under LH side of dash, near body electrical bracket .	7000- 4-2
C210 (4 pins)	Under LH side of dash, on LH side of steering column . . . . .	7000- 3-2
C211 (2 pins)	Behind RH side of radiator, taped to harness . . . . .	7000- 8-3
C214 (2 pins)	Under LH side of dash, near steering column	
C215 (2 pins)	Behind radio	
C216 (2 pins)	Behind radio	
C219 (2 pins)	RH side of trunk, near antenna . . . . .	7000- 6-1
C220 (13 pins)	Under LH side of dash, on body electrical bracket . .	7000- 4-2
C221	Under LH side of dash, left of clutch support . . . . .	7000- 9-5
C225 (1 pin)	RH side of dash, above glove box . . . . .	7000-10-2
C230 (4 pins)	Inside power distribution box . . . . .	7000- 2-6
C250 (6 pins)	Under LH side of dash	
C251 (6 pins)	Under rear console, top rear of rear blower motor . .	7000-10-3
C252 (2 pins)	Under rear console, top rear of rear evaporator . . . .	7000-10-3
C300 (2 pins)	Base of LH trunk hinge . . . . .	7000- 6-4
C301 (2 pins)	In center console, ahead of shift lever	
C302 (Accessory Connector)	Under LH side of dash, on body electrical bracket . .	7000- 4-2
C305 (4 pins)	Under LH side of dash	
C351 (2 pins)	RH front of trunk	
C352 (2 pins)	LH front of trunk . . . . .	7000- 6-6
C353 (6 pins)	Under LH side of rear seat . . . . .	7000- 9-6
C400 (13 pins)	Behind LH front speaker . . . . .	7000- 3-6
C401 (13 pins)	Behind RH front speaker . . . . .	7000- 5-1
C402 (4 pins)	Behind LH front speaker . . . . .	7000- 3-6
C503 (3 pins)	In lower rear corner of driver's door . . . . .	7000- 5-6
C520 (2 pins)	In lower rear corner of driver's door . . . . .	7000- 5-6
C551 (2 pins)	Under center console	
C552 (5 pins)	Under driver's seat	
C553 (5 pins)	Under driver's seat	
C560 (2 pins)	In driver's door	

**GROUNDS**

G101. . . . .	LH side of engine, on motor mount	
G101 (M6) . . . . .	RH rear of trunk, inside battery compartment . . . . .	7000- 9-4
G103 (Engine Ground) . . . . .	Top rear of engine . . . . .	7000- 1-6
G103 (M6) . . . . .	Center rear of engine, on No. 5 injector	
G104 (M6) . . . . .	Front LH side of engine compartment, on inner fender. . . . .	7000- 8-1
G104 (Main Body Ground) . . . . .	Inner side of LH fender, near battery . . . . .	7000- 1-2
G106. . . . .	On right hood hinge	
G200 (Front Interior Ground). . . . .	On dash frame, left of steering column	
G201 (Column Ground) . . . . .	On upper LH side of steering column . . . . .	7000- 4-4
G302 (Rear Interior Ground) . . . . .	Under LH side of rear seat . . . . .	7000- 5-2
G303. . . . .	Above LH "B" pillar	
G600. . . . .	Above headliner, above rear view mirror	

---